



No. 411

'22

PRIVATE LIBRARY

of

KIMBALL YOUNG

Stentord

7-17-20





Digitized by the Internet Archive  
in 2008 with funding from  
Microsoft Corporation



A TEXT-BOOK OF PSYCHOLOGY



THE MACMILLAN COMPANY  
NEW YORK • BOSTON • CHICAGO  
SAN FRANCISCO

MACMILLAN & CO., LIMITED  
LONDON • BOMBAY • CALCUTTA  
MELBOURNE

THE MACMILLAN CO. OF CANADA, LTD.  
TORONTO

# A TEXT-BOOK OF PSYCHOLOGY

BY

EDWARD BRADFORD TITCHENER

New York

THE MACMILLAN COMPANY

1916

*All rights reserved*

COPYRIGHT, 1896, 1897, 1899,  
BY THE MACMILLAN COMPANY.

---

Set up and electrotyped. Published July, 1896. Reprinted March, November, 1897; September, 1898. Revised and enlarged edition printed October, 1899; October, 1900; October, 1901; January, 1905; March, 1906; April, October, 1907; March, 1908.

Russian translation, 1898. Italian translation, 1902.

Revised edition under new title

COPYRIGHT, 1909, 1910,  
BY THE MACMILLAN COMPANY.

---

Set up and electrotyped. Published June, 1909. Reprinted October, 1909. Enlarged edition printed September, 1910; January, 1911; December, 1911. September, 1912; March, 1913. June, 1914. July, 1915. February, October, 1916.

German translation, 1910

BF  
131  
T74

LIBRARY  
UNIVERSITY OF CALIFORNIA  
SANTA BARBARA

TO THE MEMORY OF  
JOHN SCOTT BURDON SANDERSON



## PREFACE

THE present work has been written to take the place of my *Outline of Psychology*. The *Outline*, which was stereotyped in 1896, had long passed beyond the possibility of revision, and the continued demand for it showed that there was still room in the science for a text-book which set experimental methods and experimental results in the forefront of discussion. I should have preferred, however ungratefully, to let the book die its natural death; for I feared that it would be impossible to recover the freshness and vigour of the first writing, and I knew that another issue would lay an oppressive tax upon future time and energy. But colleagues and pupils and publisher were insistent, and I finally decided to rewrite. A first part, containing approximately half of the new work, appeared in 1909. For the benefit of those who have purchased this installment, the second part is now issued in separate form. Both parts are comprised in the present volume.

It was the intention of author and publisher that, on the completion of the *Text-book*, the *Outline* should be withdrawn from the market. They look forward to this withdrawal in the near future; meanwhile, so long as the steady demand for the book is kept up, the last edition of the *Outline* will be held on sale.—

It is, I think, unnecessary to apologise for the increase in size. If psychology is to be taken seriously, its problems must nowadays be treated in some detail. Besides, the *Text-book* aims, within its limits and upon the elementary level, at systematic completeness; it is not a digest or redaction of a larger work, to which the student may be referred for further information. I could wish, remembering some of the criticism called forth by the *Outline*, that I had a fully elaborated Systematic Psychology to fall back upon; but I am inclined to believe that, from the student's point of view, a text written expressly for the class-room is more satisfactory than the simplified version of a book written primarily for psychologists.

The *Text-book* follows, in general, the lines laid down in the *Outline*. The only point that calls for special mention here is, perhaps, the scant space accorded to nervous physiology. Readers of the Introduction, and especially of § 9, will acquit me of any desire to minimise the importance of this subject. But I have always held that the student should get his elementary knowledge of the nervous system, not from the psychologist, but from the physiologist; the teacher of psychology needs all the time at his disposal for his own science. It is true that psychology, if it is to be explanatory, must supplement the description of mental processes by a statement of their physiological conditions. But then it is also true, unfortunately, that any such statement, in the present condition of our knowledge, must be largely hypothetical. In a comprehensive work, discussion of the various physiological theories, for instance, of feeling and attention would be altogether in place; to discuss them with beginners strikes me, I confess, as a sheer waste of time. My own



plan is to show, by reference to the theory that appeals to me at the moment as the most plausible, how in principle an explanation is to be worked out. But I am careful to say that the theory itself is simply guess-work, that many other guesses have been made, and that there is a great gulf fixed between established physiological fact and the secondary constructions of physiological psychology.

A special feature of the *Outline* was the paragraph, entitled "Method," in which I showed how the reader might test for himself the statements made in the Section to which it was appended. Some of the methods thus described had been worked out only in my own laboratory; their technique was crude and their range of application restricted. Now, after fourteen years, the variety and refinement of method are so great that an adequate treatment, within text-book limits, is out of the question. Nevertheless, it is important that the student be instructed in method. And if I might offer a suggestion to teachers of psychology who propose to use this book in the class-room, it would be that they go behind my discussion, now and again, to the original sources. A topical lecture, that gives a critical account of the plan, method and results of some single investigation, is not less interesting and may sometimes be more valuable than a logically proportioned review of the entire subject-matter of a Section.

My thanks are due to my wife, and to my colleague, Professor Madison Bentley, for constant advice and assistance during the preparation of the *Text-book*. I dedicated the third edition of the *Outline* to the Regius Professor of Medicine in my old university; it was he who, in 1890, suggested the writing of the book. Sir John Burdon

Sanderson has now laid down a life full of years and honours. I owe him — as who of his pupils does not? — a heavy debt of gratitude; and I dedicate the *Text-book* to his memory.

CORNELL HEIGHTS, ITHACA, N.Y.,

July 15, 1910.

# CONTENTS

## SUBJECT-MATTER, METHOD AND PROBLEM OF PSYCHOLOGY

	PAGE
§ 1. Science and Experience . . . . .	1
§ 2. The Subject-matter of Psychology . . . . .	6
§ 3. The Common-sense View of Mind . . . . .	9
§ 4. Psychophysical Parallelism . . . . .	13
§ 5. Mental Process, Consciousness and Mind . . . . .	15
§ 6. The Method of Psychology . . . . .	19
§ 7. The Scope of Psychology . . . . .	25
§ 8. The Use of Analogy in Psychology . . . . .	30
§ 9. The Problem of Psychology . . . . .	36
References for Further Reading . . . . .	42
Note on the Classification of Psychology . . . . .	43

## SENSATION

§ 10. The Elementary Mental Processes . . . . .	46
§ 11. Elements and Attributes . . . . .	49
§ 12. The Attributes of Sensation . . . . .	52
§ 13. The Classification of Sensations . . . . .	55
References for Further Reading . . . . .	57

### THE QUALITY OF SENSATION: VISION

§ 14. The Visual Qualities . . . . .	59
§ 15. Visual Stimulus and Visual Sensation . . . . .	64
§ 16. The Dependence of Visual Sensation upon Wave-length and Energy of Light . . . . .	65
§ 17. The Dependence of Visual Sensation upon Composition of Light	67
§ 18. The Dependence of Visual Sensation upon the Time and Space Relations of Stimulus . . . . .	71

	PAGE
§ 19. Daylight and Twilight Vision . . . . .	78
§ 20. Indirect Vision and Colour Blindness . . . . .	80
§ 21. The Primary Colours . . . . .	85
§ 22. Theories of Vision . . . . .	87
References for Further Reading . . . . .	92

## AUDITION

§ 23. The Auditory Qualities . . . . .	93
§ 24. The Dependence of Auditory Sensation upon Wave-number of Sound . . . . .	97
§ 25. The Dependence of Auditory Sensation upon Composition of Sound . . . . .	100
§ 26. Beats and Intermediate Tones . . . . .	103
§ 27. Combinational Tones . . . . .	106
§ 28. Theory of Audition . . . . .	109
References for Further Reading . . . . .	113

## SMELL

§ 29. Sight and Hearing, Taste and Smell . . . . .	114
§ 30. The Olfactory Qualities . . . . .	117
§ 31. Olfactory Sensation and Olfactory Stimulus . . . . .	119
§ 32. The Dependence of Olfactory Sensation upon the Composition and Time-relations of Stimulus . . . . .	121
§ 33. Theory of Smell . . . . .	125
References for Further Reading . . . . .	128

## TASTE

§ 34. The Gustatory Qualities . . . . .	129
§ 35. Gustatory Sensation and Gustatory Stimulus . . . . .	131
§ 36. Mixtures and Adaptations . . . . .	133
§ 37. Theory of Taste . . . . .	138
References for Further Reading . . . . .	142

## CUTANEOUS SENSES

§ 38. The Skin and its Senses . . . . .	143
§ 39. The Pressure Sense . . . . .	146

	PAGE
§ 40. The Temperature Senses . . . . .	149
§ 41. The Pain Sense . . . . .	152
§ 42. Theory of the Cutaneous Senses . . . . .	155
§ 43. Tickle and Itch . . . . .	157
References for Further Reading . . . . .	159

KINÆSTHETIC SENSES

§ 44. The Kinæsthetic Senses . . . . .	160
§ 45. The Muscular Sense . . . . .	162
§ 46. The Tendinous Sense . . . . .	163
§ 47. The Articular Sense . . . . .	164
§ 48. Movement and Position, Resistance and Weight . . . . .	166
§ 49. The Alleged Sensation of Innervation . . . . .	169
§ 50. Some Touch-blends . . . . .	171
References for Further Reading . . . . .	172
§ 51. The Kinaesthetic Organs of the Internal Ear . . . . .	173
§ 52. The Ampullar Sense . . . . .	174
§ 53. Theory of the Ampullar Sense . . . . .	176
§ 54. The Vestibular Sense . . . . .	178
§ 55. Theory of the Vestibular Sense . . . . .	180
References for Further Reading . . . . .	182

OTHER ORGANIC SENSATIONS

§ 56. The Sensitivity of the Abdominal Organs . . . . .	183
§ 57. The Sensations of the Digestive and Urinary Systems . . . . .	187
§ 58. The Sensations of the Circulatory and Respiratory Systems . . . . .	189
§ 59. The Sensations of the Genital System . . . . .	191
References for Further Reading . . . . .	193

SYNAESTHESIA

§ 60. Synaesthesia . . . . .	194
§ 61. The Image . . . . .	197
References for Further Reading . . . . .	200

THE INTENSITY OF SENSATION

§ 62. The Intensity of Sensation . . . . .	201
§ 63. Mental Measurement . . . . .	207

	PAGE
§ 64. Liminal and Terminal Stimuli . . . . .	210
§ 65. The Just Noticeable Difference as the Unit of Measurement . . . . .	213
§ 66. Weber's Law . . . . .	215
§ 67. Theory of Weber's Law . . . . .	221
References for Further Reading . . . . .	224

### AFFECTION

§ 68. Feeling and Affection . . . . .	225
§ 69. Affection and Sensation . . . . .	228
§ 70. Other Views of Affection . . . . .	236
§ 71. The Methods of Investigating Affection . . . . .	240
§ 72. The Tridimensional Theory of Feeling . . . . .	250
§ 73. The Dependence of Affection upon Stimulus . . . . .	257
§ 74. The Bodily Conditions of Affection . . . . .	260
References for Further Reading . . . . .	263

### ATTENTION

§ 75. The Attentive Consciousness . . . . .	265
§ 76. The Development of Attention . . . . .	268
§ 77. The Two Levels of Consciousness . . . . .	276
§ 78. The Kinæsthetic and the Affective Factors in the Attentive Con- sciousness . . . . .	281
§ 79. The Experimental Investigation of Attention . . . . .	284
§ 80. The Range of Attention . . . . .	287
§ 81. The Duration of Attention . . . . .	291
§ 82. The Degree of Attention . . . . .	293
§ 83. Accommodation and Inertia of Attention . . . . .	296
§ 84. The Bodily Conditions of Attention . . . . .	299
References for Further Reading . . . . .	302

## PERCEPTION

## SPATIAL PERCEPTIONS

	PAGE
§ 85. The Sensory Attribute of Extent . . . . .	303
§ 86. The Third Dimension . . . . .	306
§ 87. The Stereoscope . . . . .	316
§ 88. The Perception of Space: Locality . . . . .	321
§ 89. The Perception of Space: Magnitude . . . . .	326
§ 90. Secondary Spatial Perceptions . . . . .	330
§ 91. Illusory Spatial Perceptions . . . . .	332
§ 92. Theories of Space Perception . . . . .	335
References for Further Reading . . . . .	338

## TEMPORAL PERCEPTIONS

§ 93. The Sensory Attribute of Duration . . . . .	340
§ 94. The Perception of Rhythm . . . . .	344
§ 95. Theories of Time Perception . . . . .	346
References for Further Reading . . . . .	347

## QUALITATIVE PERCEPTIONS

§ 96. Qualitative Perceptions . . . . .	349
§ 97. Tonal Fusion . . . . .	351
§ 98. Theories of Qualitative Perception . . . . .	352
References for Further Reading . . . . .	355

## COMPOSITE PERCEPTIONS

§ 99. Simple and Composite Perceptions . . . . .	357
§ 100. The Perception of Movement . . . . .	357
§ 101. The Perception of Melody . . . . .	360
References for Further Reading . . . . .	363

## THE PSYCHOLOGY OF PERCEPTION

§ 102. Pure and Mixed Perceptions . . . . .	365
§ 103. Meaning . . . . .	367
§ 104. The Form of Combination . . . . .	371
References for Further Reading . . . . .	373

## ASSOCIATION

	PAGE
§ 105. The Doctrine of Association . . . . .	374
§ 106. The Idea . . . . .	376
§ 107. The Law of Association . . . . .	378
§ 108. The Experimental Study of Association . . . . .	380
§ 109. Results: The Conditions of Impression . . . . .	382
§ 110. Results: The Conditions of Associative Tendency . . . . .	384
§ 111. The Associative Consciousness . . . . .	389
References for Further Reading . . . . .	395

## MEMORY AND IMAGINATION

§ 112. Retention: The Course of the Image. . . . .	396
§ 113. Retention: The Process of Dissociation . . . . .	401
§ 114. Retention: Individual Differences . . . . .	403
§ 115. The Recognitive Consciousness . . . . .	407
§ 116. Recognition and Direct Apprehension . . . . .	410
§ 117. The Memory Consciousness . . . . .	413
§ 118. The Memory Image and the Image of Imagination . . . . .	416
§ 119. The Imaginative Consciousness . . . . .	421
§ 120. Illusions of Recognition and Memory. . . . .	424
References for Further Reading . . . . .	426

## ACTION

§ 121. The Reaction Experiment . . . . .	428
§ 122. The Analysis of the Simple Reaction . . . . .	432
§ 123. Compound Reactions . . . . .	437
§ 124. Action . . . . .	447
§ 125. The Genesis of Action . . . . .	450
§ 126. The Classification of Action . . . . .	458
§ 127. Will . . . . .	466
References for Further Reading . . . . .	469

## EMOTION

§ 128. The Nature of Emotion . . . . .	471
§ 129. The 'James-Lange Theory' of Emotion . . . . .	474



	PAGE
§ 130. The 'James-Lange Theory': Criticism and Modification . . . . .	476
§ 131. The Organic Reaction as Constitutive of Emotion . . . . .	481
§ 132. The Organic Reaction as Expressive of Emotion . . . . .	484
§ 133. The Forms of Emotion . . . . .	489
§ 134. Emotive Memory . . . . .	493
§ 135. Mood, Passion and Temperament . . . . .	497
§ 136. The Nature of Sentiment . . . . .	498
§ 137. The Forms of Sentiment . . . . .	500
References for Further Reading . . . . .	503

**THOUGHT**

§ 138. The Nature of Conscious Attitude . . . . .	505
§ 139. The Alleged Elementary Process of Thought . . . . .	508
§ 140. The Alleged Elementary Process of Relation . . . . .	512
§ 141. The Analysis of Conscious Attitude . . . . .	515
§ 142. Language . . . . .	521
§ 143. The Abstract Idea . . . . .	525
§ 144. Generalisation and Abstraction . . . . .	529
§ 145. Comparison and Discrimination . . . . .	532
§ 146. Expectation, Practice, Habituation, Fatigue . . . . .	537
§ 147. Judgment . . . . .	540
§ 148. The Self . . . . .	544
References for Further Reading . . . . .	547

**CONCLUSION**

§ 149. The Status of Psychology . . . . .	550
References for Further Reading . . . . .	552
Index of Names . . . . .	553
Index of Subjects . . . . .	556



## INDEX OF FIGURES

FIGURE	PAGE
1. The Müller-Lyer Illusion . . . . .	7
2. The Colour Pyramid . . . . .	63
3. Model of the Colour Pyramid . . . . .	64
4. Demonstrational Colour Mixer . . . . .	69
5. Adaptation Frame . . . . .	73
6. Wundt's After-image Apparatus . . . . .	75
7. Contrast Frame . . . . .	76
8. Contrast of Shadows . . . . .	77
9. Perimeter . . . . .	81
10. Hering's Colour-blindness Apparatus . . . . .	84
11. Tuning-fork and Bottle . . . . .	93
12. The Tonal Pencil . . . . .	94
13. The Series of Auditory Qualities . . . . .	98
14. Weighted Wire Fork and Galton Whistle . . . . .	99
15. Stern's Variator . . . . .	100
16. Set of Quincke Tubes . . . . .	107
17. Koenig's Difference-tone Apparatus . . . . .	108
18. Zwaardemaker's Olfactometer (for Solids) . . . . .	121
19. Zwaardemaker's Olfactometer (for Liquids) . . . . .	122
20. Horse-hair Point for Pressure Spots . . . . .	146
21. Apparatus for Localising Warm and Cold Spots (Blix) . . . . .	149
22. Map of Warm and Cold Spots (Blix) . . . . .	150
23. Map of Pressure and Pain Spots (von Frey) . . . . .	153
24. Exner's Model of a Semicircular Canal . . . . .	177
25. Diagram of Continuous Scale of Noise Intensity . . . . .	209
26. Lehmann's Acoumeter . . . . .	213
27. Diagram of the Relation of <i>S</i> to <i>R</i> according to Weber's Law (Wundt) . . . . .	219
28. Discs for Demonstration of Weber's Law . . . . .	219

FIGURE	PAGE
29. Marey Tambour with Writing Lever . . . . .	244
30. Clockwork Kymograph . . . . .	245
31. Franck's Volumetric Sphygmograph . . . . .	245
32. The Verdin Pneumograph . . . . .	246
33. Franck's Plethysmograph . . . . .	246
34. Automatograph . . . . .	247
35. Mosso's Ergograph . . . . .	247
36. Plethysmographic Tracing . . . . .	248
37. von Frey's Sphygmograph . . . . .	248
38. Diagram of the Course of a Sense-feeling (Wundt) . . . . .	250
39. Distribution of Judgments of Unpleasantness and Tension . . . . .	254
40. Diagram of the Attentive Consciousness . . . . .	277
41. A Puzzle Picture (R. Gudden) . . . . .	278
42. Demonstrational Tachistoscope . . . . .	288
43. Masson's Disc . . . . .	292
44. Simple Complication Pendulum (Stevens) . . . . .	297
45. Model of the Horopter . . . . .	310
46. Stereoscopic Slide . . . . .	311
47. Stereoscopic Slide . . . . .	312
48. Wheatstone's Stereoscope . . . . .	317
49. Plan of Wheatstone's Stereoscope . . . . .	317
50. Plan of Brewster's Stereoscope . . . . .	318
51. Demonstrational Stereoscope . . . . .	319
52. Stereoscopic Slide . . . . .	321
53. Plan of Binocular Colour Mixer (Hering) . . . . .	321
54. Diagram Illustrating Visual Acuity (Hering) . . . . .	324
55. Blind Spot . . . . .	328
56. The Müller-Lyer Illusion: Ebbinghaus' Swallow Figure . . . . .	333
57. Mach's Book Figure . . . . .	334
58. Illusion of Movement (Bourdon) . . . . .	359
59. Artificial Waterfall (James) . . . . .	359
60. Memory Apparatus (Ranschburg) . . . . .	381
61. Field of Telescope . . . . .	429
62. Hipp's Chronoscope . . . . .	430
63. Wundt's Sound Hammer . . . . .	431
64. Telegraph Reaction Key . . . . .	431
65. Figures for Abstraction of the Like (Grünbaum) . . . . .	531

A TEXT-BOOK OF PSYCHOLOGY



# A TEXT-BOOK OF PSYCHOLOGY



## SUBJECT-MATTER, METHOD AND PROBLEM OF PSYCHOLOGY

§ 1. **Science and Experience.**—A science consists of a large body of observed facts, which are related to one another, and are arranged under general laws. If, for instance, you open a text-book of physics, you find that it gives the results of numerous observations, or prescribes experiments in which you are to observe for yourself; and you find that these results or experiments are grouped under certain main headings (mechanics, heat, electricity) and are made to illustrate certain comprehensive laws (Newton's laws of motion, Kirchoff's law of radiation, Ohm's law of the strength of the electric current). All scientific text-books, whether the science is physics or chemistry, biology or psychology, philology or economics, are of the same pattern.

It is worth while, before we begin our special study of psychology, briefly to consider some of the questions which this definition of science suggests. How, we may ask, do the various sciences come into being? How are they differentiated, their several fields laid out and marked off? What do we mean when we say that the facts of any given science are related to one another? What is the nature of the relation? What precisely is a scientific

## 2 *Subject-matter, Method and Problem of Psychology*

law? Why is it important for the progress of science that laws should be established? An answer, even a rough answer, to these questions will help us to understand the scope and aim of psychology.

First of all, then, it is plain that all the sciences have the same sort of subject-matter; they all deal with some phase or aspect of the world of human experience. If we take a mere fragment of this world, — say, our own experience during a single day, — we find it a rather hopeless mixture. Our lawn-sprinkler obeys the third law of motion, while our pleasure in possessing it is a fact for psychology; the preparation of our food is an applied chemistry, its adulteration depends upon economic conditions, and its effect upon health is a matter of physiology; our manner of speech is governed by phonetic laws, while the things we say reflect the moral standards of the time: in a word, one science seems to run into another science as chance may decide, without order or distinction. If, however, we look over the world as a whole, or examine historically any long period of human existence, the survey is less bewildering. The world of nature breaks up at once, as we inspect it, into living objects, the objects that change by growth, and non-living objects, the objects that change only by decay. And living objects divide, again, into objects that grow in one place, the plants, and objects that move about as they grow, the animals. Here, almost at the first glance, we have distinguished the raw materials of three different sciences: geology, botany, zoology. Now let us turn to some stage of human evolution: we may choose the social life of mankind before the dawn of civilisation. Primitive man was required, by the necessities of his case, to make himself weapons; to hunt animals for



food ; to protect himself by clothing and shelter, and to avoid eating or drinking from poisonous or tainted sources. If he ventured upon the water, he must steer his course by the stars ; if he banded with his fellows, he must hold to the code of honour of the tribe. He dreamed, and told his dreams ; when he was glad, or angry, or afraid, he showed his feeling in gesture or by the expression of his face. Doubtless, his daily experience, if he ever thought about it, seemed to him as chaotic as our own has just appeared to us. But we, who have a larger vision of that experience, can see that it contained the natural germs of many sciences : mechanics, zoology and physiology, — astronomy, ethics and psychology.

We are thus led to the conclusion that the world of human experience is not altogether confused and disorderly. It shows lines of cleavage ; to a certain extent, it arranges itself for us ; so that the raw materials or the natural germs of what, in the higher forms of civilisation, become the separate sciences force themselves separately upon the attention. But we have not, as yet, anything more than raw materials. Science appears only when some man, taking the hint from nature, deliberately follows up a special line of enquiry throughout the whole of experience. Bridges and dwellings and weapons and furniture and tools and utensils were made long before there was a science of mechanics. The science begins when men begin to interpret the universe in mechanical terms, when the world at large is looked upon as a vast machine, working precisely as a tool or an engine works. Dreams, and the phenomena of trance, and the movements which express emotion were observed long before there was a science of psychology. The science begins when

men begin to interpret the universe in psychological terms, when the world at large is looked upon as mind, as a body of experience subject to psychological laws. In a word, every science takes up a certain attitude towards the world of human experience, or regards it from a definite point of view, and it is the business of a science to describe the world as it appears after the attitude has been taken up or the point of view adopted. What differentiates the sciences is just this difference of human interest; and what holds a science together, and brings its observations into relation, is just the fact that all the work has been done under the guidance of the same principles and from the same point of view.

We have now answered some of our general questions. Experience, we have seen, presents itself under different aspects. The differences are roughly outlined, but are definite enough to serve as a starting-point. These different aspects engage the attention of different men. Division of labour is necessary, if the whole of experience is to be brought within the sphere of science; and men's interests are so various that every aspect of experience is sure, in the long run, to find a student. As scientific investigation proceeds, and as the number of scientific men increases, more and more aspects of experience are revealed, and the sciences multiply. They do not exist independently, side by side, as accounts of separate portions of the world or of separate regions of experience; they overlap and coincide, describing one and the same world of experience as it appears from their special standpoints. They are not like blocks of knowledge, which when cut to the proper size and properly fitted together will give us a map of the universe; they are rather like the successive chapters of a

book which discusses a large topic from every possible point of view. Some chapters are long, and some are short; some are general, and some are special: this depends upon the sort of attitude which a given science takes towards experience. But all the chapters, or sciences, deal with the same world under its various aspects. —

We have still to enquire what science means by a law, and why it is that the advance of science depends upon the establishment of laws. The answer is simple. The longer scientific observations are continued, and the more scientific methods are refined, the clearer does it become that experience is regular and orderly. If only the conditions of an occurrence remain the same, the occurrence will always take place in the same way. A scientific law thus expresses a regularity, an unbroken uniformity, of some aspect of experience. Go to a dictionary, and look up Charles' law, and Grimm's law, and Weber's law: you will find that in all three cases — physics, philology, psychology — the laws are of this sort.

The formulation of a scientific law, therefore, means the final writing of some paragraph in some chapter of that book of the world which contains all the different sciences. No science is as yet complete: but the formulation of a law means that the science of which it holds is complete up to a certain point. The law embraces, covers, summarises a large body of observations, and also serves as a point of departure for the making of fresh observations. This is why the important dates in the history of science are the years in which scientific laws were established, and why the most honoured names in science are the names of the men who established them. It would, perhaps, make the study of science easier for the beginner if all proper names were

omitted, and we ceased to speak of the principle of Archimedes, and Euclidean geometry, and Newton's laws of motion. But these terms serve a good purpose : they show the importance of scientific laws, and they also reinforce a conclusion at which we have already arrived, — that what differentiates the sciences is the difference of human interests, and that what makes a science is some man's consistent adherence to a definite point of view.

§ 2. **The Subject-matter of Psychology.**—If it is true that all the sciences have the same sort of subject-matter, there can be no essential difference between the raw materials of physics and the raw materials of psychology. Matter and mind, as we call them, must be fundamentally the same thing. Let us find out, now, whether this statement is really as paradoxical as at first thought it appears.

All human knowledge is derived from human experience; there is no other source of knowledge. But human experience, as we have seen, may be considered from different points of view. Suppose that we take two points of view, as far as possible apart, and discover for ourselves what experience looks like in the two cases. First, we will regard experience as altogether independent of any particular person; we will assume that it goes on whether or not anyone is there to have it. Secondly, we will regard experience as altogether dependent upon the particular person; we will assume that it goes on only when someone is there to have it. We shall hardly find stand-points more diverse. What are the differences in experience, as viewed from them?

Take, to begin with, the three things that you first learn

about in physics: space, time and mass. Physical space, which is the space of geometry and astronomy and geology, is constant, always and everywhere the same. Its unit is 1 cm., and the cm. has precisely the same value wherever and whenever it is applied. Physical time is similarly constant; and its constant unit is the 1 sec. Physical mass is constant; its unit, the 1 gr., is always and everywhere the same. Here we have experience of space, time and mass considered as independent of the person who experiences them. Change, then, to the point of view which brings the experiencing person into account. The two vertical lines in Fig. 1 are physically equal; they measure alike in units of 1 cm. To you, who see them, they are not equal. The hour that you spend in the waiting-room of a village station and the hour that you spend in watching an amusing play are physically equal; they measure alike in units of 1 sec. To you, the one hour goes slowly, the other quickly; they are not equal. Take two circular cardboard boxes of different diameter (say, 2 cm. and 8 cm.), and pour sand into them until they both weigh, say, 50 gr. The two masses are physically equal; placed on the pans of a balance, they will hold the beam level. To you, as you lift them in your two hands, or raise them in turn by the same hand, the box of smaller diameter is considerably the heavier. Here we have experience of space, time and mass considered as dependent upon the experiencing person. It is the same experience that we were discussing just now. But our first point of view



FIG. 1.

## 8 *Subject-matter, Method and Problem of Psychology*

gives us facts and laws of physics; our second gives us facts and laws of psychology.

Now take three other topics that are discussed in the physical text-books: heat, sound and light. Heat proper, the physicists tell us, is the energy of molecular motion; that is to say, heat is a form of energy due to a movement of the particles of a body among themselves. Radiant heat belongs, with light, to what is called radiant energy, —energy that is propagated by wave-movements of the luminiferous ether with which space is filled. Sound is a form of energy due to the vibratory movements of bodies, and is propagated by wave-movements of some elastic medium, solid, liquid or gaseous. In brief, heat is a dance of molecules; light is a wave-motion of the ether; sound is a wave-motion of the air. The world of physics, in which these types of experience are considered as independent of the experiencing person, is neither warm nor cold, neither dark nor light, neither silent nor noisy. It is only when the experiences are considered as dependent upon some person that we have warmth and cold, blacks and whites and colours and greys, tones and hisses and thuds. And these things are subject-matter of psychology.

We find, then, a great difference in the aspect of experience, according as it is viewed from the one or the other of our different standpoints. It is the same experience all through; physics and psychology deal with the same stuff, the same material; the sciences are separated simply — and sufficiently — by their point of view. From the standpoint of physics, we get such sciences as physics (in the narrower sense), chemistry, geology, astronomy, meteorology. From the standpoint of psychology we get, in the

same way, a special group of sciences: their names and provinces are given in § 7.

It must be clearly understood that we are not here attempting to give a strict definition of the subject-matter of psychology. We assume that everybody knows, at first hand, what human experience is, and we then seek to mark off the two aspects of this experience which are dealt with respectively by physics and psychology. Any further definition of the subject-matter of psychology is impossible. Unless one knows, by experience itself, what experience is, one can no more give a meaning to the term 'mind' than a stone can give a meaning to the term 'matter.'

§ 3. **The Common-sense View of Mind.** — If, before you read the two preceding sections, you had been asked to define psychology, you would probably have said, without hesitation, that it is the science of mind. But you would have meant by mind something that, at all events in appearance, is very different from the meaning that these two sections have given it. Let us see how nearly we can reconcile the common-sense idea of mind with the view that it is the sum-total of human experience considered as dependent upon the experiencing person.

The common-sense idea of the world is roughly this. The world is made up of, or contains, two radically different things: matter and mind. Matter is found in the physical objects around us; it always fills space; it is governed by mechanical laws, laws of cause and effect. Mind is found in ourselves and, very likely, in some of the other animals; it is immaterial, not spatial; it is not bound by mechanical laws, but is free to act as it will; if it submits to laws at all (as, for instance, to the laws of thought in our processes of reasoning), these are laws peculiar to it, and are not the same as the laws of nature. Nevertheless,



different as mind and matter are, they are joined together, in a very intimate way, both in ourselves and in such of the animals as possess minds; for our physical bodies are material. And when they are thus joined together, they act upon each other, mind affecting matter and matter affecting mind. We cry because we are grieved; we cannot think clearly because we have eaten too heavy a dinner.

Compare these statements, now, with the statements of §§ 1 and 2. Common sense declares that mind and matter are radically different. We have said that, in order to get the subject-matter of physics and of psychology, one must regard human experience from standpoints as diverse as can be found. So far there is a general agreement. Common sense declares that the laws of matter are different from the laws of mind. We have seen that, for instance, space, time and mass behave very differently, according as they are taken to be independent of, or dependent upon, the experiencing person. Again there is agreement. Common sense declares that we, and perhaps the animals, are made up both of matter and of mind. Here also, if we go beneath the difference of terms, there is agreement. The living body, as it is treated in the science of physiology, is treated from the physical point of view; it belongs to the independent aspect of experience. The same living body — that is to say, an organism, an organised individual — is, however, precisely the 'experiencing person' referred to in our definition of mind. It is when heat-waves strike the skin, and sound-waves strike the ear, and light-waves strike the eye, that we have experience in its dependent aspect, as warmth and tone and colour. On these three points, therefore, we have no serious quarrel with common sense.

On the other hand, common sense makes certain other



statements that we cannot accept. These statements all point to a view of mind which is not often expressed outright, in so many words, but which is very generally held: the view, namely, that mind is a living being, with all the qualities and powers that are possessed by material living beings; an immaterial animal, so to say, that dwells within the material animal; an inward man, manifesting itself in the behaviour of the outward man. A mind so conceived cannot fill space, because it is not material; but it has all the other properties of a living creature. It is free to act as it pleases, just as you are free to come or to go, to do this or to do that. It can influence the body, and be influenced by the body, just as you may influence or be influenced by your friend. This view of mind probably appears natural enough, although, as soon as you begin to ask questions, you will find that it is by no means clear. Natural or not, however, it is a view which we must here reject, for the following reasons.

(1) A statement that rests upon common sense is not likely to be argued; it is taken for granted, as something that needs no discussion. Yet, in theoretical matters, common sense is an unsafe guide. For the common sense of our own generation simply sums up so much of the advanced thought of former generations as the great body of mankind has found acceptable and intelligible. A brilliant speculation of one age may become the common sense of the next: but this does not make it any the less speculation, while in the course of becoming common sense its logical structure has, inevitably, been more or less damaged. Common sense, in theoretical matters, is past philosophy; and the philosophy is the more vulgarised, the farther it has travelled from its source.

There is no dispute as to the philosophical source from which, in the present instance, our common-sense ideas are derived. The view of mind and matter which we are now criticising was set forth, in all essential points, by the French philosopher, René Descartes (1596-1650). No doubt, the common-sense version has certain crude elements which are indefinitely older than Descartes; no doubt, also, it has been tinged by later thought, notably by the doctrine of organic evolution. In the main, however, what is common sense to-day was high Cartesian philosophy two centuries and a half ago.<sup>1</sup>

Plainly, then, we cannot take common sense for granted. As we should not nowadays pin our philosophical faith to Descartes, so we cannot leave Cartesian doctrines unquestioned when they appear in the garb of common sense. We shall rather expect to find that Descartes, and with him our own common sense, are partly right and partly wrong.

(2) That some of the doctrines of common sense agree, in general, with the position of §§ 1 and 2 has already been shown. The remainder must be rejected, because the evidence is against them. We are told that mind is not spatial: yet, as Fig. 1 shows, mental experience takes on the spatial form as readily as physical experience. We are told that mind is free to act as it pleases: yet, as we shall see in this book, the more carefully mind is studied, the more plainly are the laws of mental experience revealed. We are told that mind influences body, and

<sup>1</sup> You will find that this statement is borne out by the histories of philosophy. Turn, for instance, to A. K. Rogers, *A Student's History of Philosophy*, 1901, pp. 269-289, especially 284-287. The passage is not easy reading: but you will understand it well enough to see that what is said in the text is historically correct.

body mind. How an immaterial thing can influence and be influenced by a material thing we are not told,—for the very good reason that nobody knows: though, if this were the only view that did justice to the facts, we should nevertheless be bound to accept it. Since, as the following section shows, all the observed facts can be rationally explained from the standpoint of §§ 1 and 2, this standpoint must be preferred.

§ 4. **Psychophysical Parallelism.**—Common sense says that we cry because we are sorry, laugh because we are amused, run because we are frightened; that we feel gloomy and morose because we do not digest our food, go insane from softening of the brain, lose consciousness because we have inhaled ether. Mind influences body, and body influences mind. Our own position has been that mind and body, the subject-matter of psychology and the subject-matter of physiology, are simply two aspects of the same world of experience. They cannot influence each other, because they are not separate and independent things. For the same reason, however, wherever the two aspects appear, any change that occurs in the one will be accompanied by a corresponding change in the other. Your view of a town from the east cannot influence your view of the same town from the west; but as your view from the east differs in sunlight and moonlight, so correspondingly will your view from the west differ. This doctrine of the relation of mind to body is known as the doctrine of psychophysical parallelism: the common-sense doctrine is that of interaction.

From the point of view of psychophysical parallelism, then, it is not strictly true to say that we cry because we

are sorry. If we look at the whole experience under its independent aspect, we find that certain physical events, certain stimuli, affect the body; they set up in the body, and especially in the nervous system, certain physical changes; these changes cause the secretion of tears. This is an exhaustive account of the experience, considered as independent of the experiencing person. If we look at the experience under its dependent aspect, we find that our consciousness has been invaded by grief or remorse or some kindred emotion. The two sets of events, physical and mental, are parallel, but they do not interfere with each other. And the same thing holds of all the other cases cited at the beginning of this section.

By accepting this doctrine of parallelism we gain a two-fold advantage. On the positive side, we are able to do justice to all the observed facts; we never come into contradiction with facts. On the negative side, we avoid perplexing questions, questions that lead nowhere because they are put from a wrong standpoint. The common-sense view of mind appears natural; but as soon as you ask questions, you find it obscure. Where, for instance, on that view, does the body end and the mind begin? Do the senses belong to mind or to body? Is the mind always active and the body always passive? Do body and mind ever act independently of each other? Questions such as these arise at once; but it is a hard matter to answer them. Parallelism has no logical pitfalls of this kind.

At the same time, we need not be pedantic, and change our manner of speech to accord with the strict letter of parallelism. The astronomer does not scruple to talk, with all the rest of us, about sunrise and sunset. It is not strictly

true to say that we cry because we are sorry; our crying is the effect of certain nervous (that is, physical) changes, whose parallel on the mental side is the emotion of grief. But this parallel is constant and invariable. We should not cry, under the circumstances, unless we were sorry, because our sorrow is the mental aspect of those nervous changes that make us cry: we have only to shift our point of view, and what appeared as nervous change appears as emotion. So that, for all practical purposes, it is true to say that we cry because we are sorry, and run because we are frightened, and so forth. What we have to guard against is not the phrasing of these statements, but their popular interpretation. To suppose that the sorrow and the fear are literally the cause of tears and bodily movements would be on a par with supposing that the idea of watering the lawn can, literally and directly, turn the tap and set the sprinkler in motion.

§ 5. **Mental Process, Consciousness and Mind.** — The most striking fact about the world of human experience is the fact of change. Nothing stands still; everything goes on. The sun will someday lose its heat; the eternal hills are, little by little, breaking up and wearing away. Whatever we observe, and from whatever standpoint we observe it, we find process, occurrence; nowhere is there permanence or stability. Mankind, it is true, has sought to arrest this flux, and to give stability to the world of experience, by assuming two permanent substances, matter and mind: the occurrences of the physical world are then supposed to be manifestations of matter, and the occurrences of the mental world to be manifestations of mind. Such an hypothesis may be of value at a certain stage of human

thought; but every hypothesis that does not accord with the facts must, sooner or later, be given up. Physicists are therefore giving up the hypothesis of an unchanging, substantial matter, and psychologists are giving up the hypothesis of an unchanging, substantial mind. Stable objects and substantial things belong, not to the world of science, physical or psychological, but only to the world of common sense.

We have defined mind as the sum-total of human experience considered as dependent upon the experiencing person. We have said, further, that the phrase 'experiencing person' means the living body, the organised individual; and we have hinted that, for psychological purposes, the living body may be reduced to the nervous system and its attachments. Mind thus becomes the sum-total of human experience considered as dependent upon a nervous system. And since human experience is always process, occurrence, and the dependent aspect of human experience is its mental aspect, we may say, more shortly, that mind is the sum-total of mental processes. All these words are significant. 'Sum-total' implies that we are concerned with the whole world of experience, not with a limited portion of it; 'mental' implies that we are concerned with experience under its dependent aspect, as conditioned by a nervous system; and 'processes' implies that our subject-matter is a stream, a perpetual flux, and not a collection of unchanging objects.

It is not easy, even with the best will possible, to shift from the common-sense to the scientific view of mind; the change cannot be made all in a moment. We are to regard mind as a stream of processes? But mind is personal, my mind; and my personality continues throughout my life. The experiencing person is only the bodily organism? But, again, experience is personal, the

experience of a permanent self. Mind is spatial, just as matter is? But mind is invisible, intangible; it is not here or there, square or round.

These objections cannot be finally met until we have gone some distance into psychology, and can see how the scientific view of mind works out. Even now, however, they will weaken as you look at them. Face that question of personality. Is your life, as a matter of fact, always personal? Do you not, time and again, forget yourself, lose yourself, disregard yourself, neglect yourself, contradict yourself, in a very literal sense? Surely, the mental life is only intermittently personal. And is your personality, when it is realised, unchanging? Are you the same self in childhood and manhood, in your working and in your playing moods, when you are on your best behaviour and when you are freed from restraint? Surely, the self-experience is not only intermittent, but also composed, at different times, of very different factors. As to the other question: mind is, of course, invisible, because sight is mind; and mind is intangible, because touch is mind. Sight-experience and touch-experience are dependent upon the experiencing person. But common sense itself bears witness, against its own belief, to the fact that mind is spatial: we speak, and speak correctly, of an idea in our head, a pain in our foot. And if the idea is the idea of a circle seen in the mind's eye, it is round; and if it is the visual idea of a square, it is square.

Consciousness, as reference to any dictionary will show, is a term that has many meanings. Here it is, perhaps, enough to distinguish two principal uses of the word.

In its first sense, consciousness means the mind's awareness of its own processes. Just as, from the common-sense point of view, mind is that inner self which thinks, remembers, chooses, reasons, directs the movements of the body, so is consciousness the inner knowledge of this thought and government. You are conscious of the correctness of your answer to an examination question, of



the awkwardness of your movements, of the purity of your motives. Consciousness is thus something more than mind; it is "the perception of what passes in a man's own mind";<sup>1</sup> it is "the immediate knowledge which the mind has of its sensations and thoughts."<sup>2</sup>

In its second sense, consciousness is identified with mind, and 'conscious' with 'mental.' So long as mental processes are going on, consciousness is present; as soon as mental processes are in abeyance, unconsciousness sets in. "To say I am conscious of a feeling, is merely to say that I feel it. To have a feeling is to be conscious; and to be conscious is to have a feeling. To be conscious of the prick of the pin, is merely to have the sensation. And though I have these various modes of naming my sensation, by saying, I feel the prick of a pin, I feel the pain of a prick, I have the sensation of a prick, I have the feeling of a prick, I am conscious of the feeling; the thing named in all these various ways is one and the same."<sup>3</sup>

The first of these definitions we must reject. It is not only unnecessary, but it is also misleading, to speak of consciousness as the mind's awareness of itself. The usage is unnecessary, because, as we shall see later, this awareness is a matter of observation of the same general kind as observation of the external world; it is misleading, because it suggests that mind is a personal being, instead of a stream of processes. We shall therefore

<sup>1</sup> John Locke, *An Essay Concerning Human Understanding*, [1690] Bk. II., Ch. i., § 19.

<sup>2</sup> Dugald Stewart, *Outlines of Moral Philosophy*, [1793] Pt. I., Section i., § 7.

<sup>3</sup> James Mill, *Analysis of the Phenomena of the Human Mind*, [1829] Vol. I., Ch. v. Mill uses the word 'feeling' to denote what we have called 'mental process.'



take mind and consciousness to mean the same thing. But as we have the two different words, and it is convenient to make some distinction between them, we shall speak of mind when we mean the sum-total of mental processes occurring in the life-time of an individual, and we shall speak of consciousness when we mean the sum-total of mental processes occurring *now*, at any given 'present' time. Consciousness will thus be a section, a division, of the mind-stream. This distinction is, indeed, already made in common speech: when we say that a man has 'lost consciousness,' we mean that the lapse is temporary, that the mental life will shortly be resumed; when we say that a man has 'lost his mind,' we mean — not, it is true, that mind has altogether disappeared, but certainly that the derangement is permanent and chronic.

While, therefore, the subject-matter of psychology is mind, the direct object of psychological study is always a consciousness. In strictness, we can never observe the same consciousness twice over; the stream of mind flows on, never to return. Practically, we can observe a particular consciousness as often as we wish, since mental processes group themselves in the same way, show the same pattern of arrangement, whenever the organism is placed under the same circumstances. Yesterday's high tide will never recur, and yesterday's consciousnesses will never recur; but we have a science of psychology, as we have a science of oceanography.

§ 6. **The Method of Psychology.** — Scientific method may be summed up in the single word 'observation'; the only way to work in science is to observe those phenomena which form the subject-matter of science. And observa-

tion implies two things: attention to the phenomena, and record of the phenomena; that is, clear and vivid experience, and an account of the experience in words or formulas.

In order to secure clear experience and accurate report, science has recourse to experiment. An experiment is an observation that can be repeated, isolated and varied. The more frequently you can *repeat* an observation, the more likely are you to see clearly what is there and to describe accurately what you have seen. The more strictly you can *isolate* an observation, the easier does your task of observation become, and the less danger is there of your being led astray by irrelevant circumstances, or of placing emphasis on the wrong point. The more widely you can *vary* an observation, the more clearly will the uniformity of experience stand out, and the better is your chance of discovering laws. All experimental appliances, all laboratories and instruments, are provided and devised with this one end in view: that the student shall be able to repeat, isolate and vary his observations. —

The method of psychology, then, is observation. To distinguish it from the observation of physical science, which is inspection, a looking-at, psychological observation has been termed introspection, a looking-within. But this difference of name must not blind us to the essential likeness of the methods. Let us take some typical instances.

We may begin with two very simple cases. (1) Suppose that you are shown two paper discs: the one of an uniform violet, the other composed half of red and half of blue. If this second disc is rapidly rotated, the red and blue will mix, as we say, and you will see a certain blue-red, that is, a kind of violet. Your problem is, so to adjust the pro-

portions of red and blue in the second disc that the resulting violet exactly matches the violet of the first disc. You may repeat this set of observations as often as you like; you may isolate the observations by working in a room that is free from other, possibly disturbing colours; you may vary the observations by working to equality of the violets first from a two-colour disc that is distinctly too blue, and secondly from a disc that is distinctly too red. (2) Suppose, again, that the chord *c-e-g* is struck, and that you are asked to say how many tones it contains. You may repeat this observation; you may isolate it, by working in a quiet room; you may vary it, by having the chord struck at different parts of the scale, in different octaves.

It is clear that, in these instances, there is practically no difference between introspection and inspection. You are using the same method that you would use for counting the swings of a pendulum, or taking readings from a galvanometer scale, in the physical laboratory. There is a difference in subject-matter: the colours and the tones are dependent, not independent experiences: but the method is essentially the same.

Now let us take some cases in which the material of introspection is more complex. (1) Suppose that a word is called out to you, and that you are asked to observe the effect which this stimulus produces upon consciousness: how the word affects you, what ideas it calls up, and so forth. The observation may be repeated; it may be isolated, — you may be seated in a dark and silent room, free from disturbances; and it may be varied, — different words may be called out, the word may be flashed upon a screen instead of spoken, etc. Here, however, there seems

to be a difference between introspection and inspection. The observer who is watching the course of a chemical reaction, or the movements of some microscopical creature, can jot down from moment to moment the different phases of the observed phenomenon. But if you try to report the changes in consciousness, while these changes are in progress, you interfere with consciousness; your translation of the mental experience into words introduces new factors into that experience itself. (2) Suppose, again, that you are observing a feeling or an emotion: a feeling of disappointment or annoyance, an emotion of anger or chagrin. Experimental control is still possible; situations may be arranged, in the psychological laboratory, such that these feelings may be repeated, isolated and varied. But your observation of them interferes, even more seriously than before, with the course of consciousness. Cool consideration of an emotion is fatal to its very existence; your anger disappears, your disappointment evaporates, as you examine it.

To overcome this difficulty of the introspective method, students of psychology are usually recommended to delay their observation until the process to be described has run its course, and then to call it back and describe it from memory. Introspection thus becomes retrospection; introspective examination becomes *post mortem* examination. The rule is, no doubt, a good one for the beginner; and there are cases in which even the experienced psychologist will be wise to follow it. But it is by no means universal. For we must remember (*a*) that the observations in question may be repeated. There is, then, no reason why the observer to whom the word is called out, or in whom the emotion is set up, should not report at once upon the first

stage of his experience: upon the immediate effect of the word, upon the beginnings of the emotive process.<sup>1</sup> It is true that this report interrupts the observation. But, after the first stage has been accurately described, further observations may be taken, and the second, third and following stages similarly described; so that presently a complete report upon the whole experience is obtained. There is, in theory, some danger that the stages become artificially separated; consciousness is a flow, a process, and if we divide it up we run the risk of missing certain intermediate links. In practice, however, this danger has proved to be very small; and we may always have recourse to retrospection, and compare our partial results with our memory of the unbroken experience. Moreover, (*b*) the practised observer gets into an introspective habit, has the introspective attitude ingrained in his system; so that it is possible for him, not only to take mental notes while the observation is in progress, without interfering with consciousness, but even to jot down written notes, as the histologist does while his eye is still held to the ocular of the microscope.

In principle, then, introspection is very like inspection. The objects of observation are different; they are objects of dependent, not of independent experience; they are likely to be transient, elusive, slippery. Sometimes they refuse to be observed while they are in passage; they must be preserved in memory, as a delicate tissue is pre-

<sup>1</sup> We discuss in § 69, where we are dealing with the elementary processes in emotion, the special difficulty mentioned above: that, if you concentrate your attention, say, upon your anger, the anger disappears. This difficulty makes it necessary to lay down special rules for the observation of emotion. But it does not make it necessary — and that is the point here — to observe emotion retrospectively.

served in hardening fluid, before they can be examined. And the standpoint of the observer is different; it is the standpoint of human life and of human interest, not of detachment and aloofness. But, in general, the method of psychology is much the same as the method of physics.

It must not be forgotten that, while the method of the physical and the psychological sciences is substantially the same, the subject-matter of these sciences is as different as it can well be. Ultimately, as we have seen, the subject-matter of all the sciences is the world of human experience; but we have also seen that the aspect of experience treated by physics is radically different from the aspect treated by psychology. The likeness of method may tempt us to slip from the one aspect to the other, as when a text-book of physics contains a chapter on vision and the sense of colour, or a text-book of physiology contains paragraphs on delusions of judgment; but this confusion of subject-matter must inevitably lead to confusion of thought. Since all the sciences are concerned with the one world of human experience, it is natural that scientific method, to whatever aspect of experience it is applied, should be in principle the same. On the other hand, when we have decided to examine some particular aspect of experience, it is necessary that we hold fast to that aspect, and do not shift our point of view as the enquiry proceeds. Hence it is a great advantage that we have the two terms, introspection and inspection, to denote observation taken from the different standpoints of psychology and of physics. The use of the word introspection is a constant reminder that we are working in psychology, that we are observing the dependent aspect of the world of experience.

Observation, as we said above, implies two things: attention to the phenomena, and record of the phenomena. The attention must be held at the highest possible degree of concentration; the record must be photographically accurate. Observation is, therefore, both difficult and fatiguing; and introspection is, on the whole, more difficult and more fatiguing than inspection. To

secure reliable results, we must be strictly impartial and unprejudiced, facing the facts as they come, ready to accept them as they are, not trying to fit them to any preconceived theory; and we must work only when our general disposition is favourable, when we are fresh and in good health, at ease in our surroundings, free from outside worry and anxiety. If these rules are not followed, no amount of experimenting will help us. The observer in the psychological laboratory is placed under the best possible external conditions; the room in which he works is fitted up and arranged in such a way that the observation may be repeated, that the process to be observed may stand out clearly upon the background of consciousness, and that the factors in the process may be separately varied. But all this care is of no avail, unless the observer himself comes to the work in an even frame of mind, gives it his full attention, and is able adequately to translate his experience into words.

§ 7. **The Scope of Psychology.** — If mind is the sum-total of human experience considered as dependent upon the experiencing person, it follows that each one of us can have direct acquaintance only with a single mind, namely, with his own. We are concerned in psychology with the whole world of human experience; but we are concerned with it solely under its dependent aspect, as conditioned by a nervous system; and a nervous system is a particular thing, possessed by a particular individual. In strictness, therefore, it is only his own mind, the experience dependent upon his own nervous system, that each of us knows at first-hand; it is only to this limited and individual subject-matter that the method of experimental introspection can be directly applied. How, then, is a scientific psychology possible? How can psychology be anything more than a body of personal beliefs and individual opinions?



The difficulty is more apparent than real. We have every reason to believe, not only in general that our neighbours have minds like our own, that is, are able like ourselves to view experience in its dependent aspect, but also in detail that human minds resemble one another precisely as human bodies do. Within a given race there is much apparent diversity of outward form: differences in height and figure, in colour of hair and eyes, in shape of nose and mouth. We notice these differences, because we are obliged in everyday life to distinguish the persons with whom we come in contact. But the resemblances are more fundamental than the differences. If we have recourse to exact measurements, we find that there is in every case a certain standard or type to which the individual more or less closely conforms and about which all the individuals are more or less closely grouped. And even without measurement we have evidence to the same effect: strangers see family likenesses which the members of the family cannot themselves detect, and the units in a crowd of aliens, Chinese or Negroes, look bewilderingly alike.

Now all of our main social institutions rest upon the assumption that the individuals of whom society is composed possess minds, and possess minds that are of the same sort. Language, religion, law and custom, — they one and all rest upon this assumption, and they one and all bear testimony that the assumption is well grounded. Would a man invent language in order to talk to himself? Language implies that there are more minds than one. And would the use of a common speech be possible if minds were not essentially alike? Men differ in their command of language, as they differ in complexion, or in



liability to disease; but the general use of language testifies to a fundamental likeness of mental constitution in us all.

Hence the psychologist is fully justified in believing that other men have minds of the same kind as his own, and in basing psychology upon the introspective reports furnished by a number of different observers. These reports show, in point of fact, just what we should expect them to show: a fundamental agreement, and a great variety of detail, — the mental differences grouping themselves, as we have seen that physical differences group themselves, about a central type or standard.

If, however, we attribute minds to other human beings, we have no right to deny them to the higher animals. These animals are provided with a nervous system of the same pattern as ours, and their conduct or behaviour, under circumstances that would arouse certain feelings in us, often seems to express, quite definitely, similar feelings in them. Surely we must grant that the highest vertebrates, mammals and birds, have minds. But the lower vertebrates, fishes and reptiles and amphibia, possess a nervous system of the same order, although of simpler construction. And many of the invertebrates, insects and spiders and crustaceans, show a fairly high degree of nervous development. Indeed, it is difficult to limit mind to the animals that possess even a rudimentary nervous system; for the creatures that rank still lower in the scale of life manage to do, without a nervous system, practically everything that their superiors do by its assistance. The range of mind thus appears to be as wide as the range of animal life.

The plants, on the other hand, appear to be mindless. Many of them are endowed with what we may term sense-organs, that is,

organs differentiated to receive certain forms of stimulus, pressure, impact, light, etc. These organs are analogous in structure to the sense-organs of the lower animal organisms: thus, plant 'eyes' have been found, which closely resemble rudimentary animal eyes, and which — if they belonged to animals — might mediate the perception of light: so that the development of the plant-world has evidently been governed by the same general laws of adaptation to environment that have been at work in the animal kingdom. But we have no evidence of a plant-consciousness.

Just as the scope of psychology extends beyond man to the animals, so does it extend from the individual man to groups of men, to societies. The subject-matter of psychology is human experience considered as dependent upon the individual. But since the individuals of the same race and epoch are organised in much the same way, and since they live together in a society where their conduct affects and is affected by the conduct of others, their view of experience under its dependent aspect naturally becomes, in certain main features, a common or general view; and this common view is embodied in those social institutions to which we have referred above, — in language, religion, law and custom. There is no such thing as a collective mind, or a national mind, or a social mind, if we mean by mind some immaterial being; but there is a collective mind, if we mean by it the sum-total of human experience considered as dependent upon a social group of similar individuals. The study of the collective mind gives us a psychology of language, a psychology of myth, a psychology of custom, etc.; it also gives us a differential psychology of the Latin mind, of the Anglo-Saxon mind, of the Oriental mind, etc.

And this is not all: the scope of psychology extends,

still further, from the normal to the abnormal mind. Life, as we know, need not be either complete or completely healthy life. The living organism may show defect, the lack of a limb or of a sense-organ; and it may show disorder and disease, a temporary or a permanent lapse from health. So it is with mind. The consciousnesses of those who are born deaf or blind are defective; they lack certain sensations and images that are normally present. In dreaming and the hypnotic state, during intoxication, after prolonged sleeplessness or severe strain of any kind, we have illustrations of temporary mental derangement. And the various forms of insanity—mania, melancholia, dementia—are forms of permanent mental disorder.

Derangement of the social mind may be studied in the various panics, fads, epidemics of speculation, of false belief, etc., which occur from time to time even in the most highly civilised societies. The mob consciousness stands to a healthy social consciousness very much as dreaming to the waking life. Permanent disorder of the social mind means the downfall of society.

All these various fields of psychology may be cultivated for their own sake, on account of their intrinsic interest and value; they must, indeed, be so cultivated, if psychology is to progress. At the same time, their facts and laws often throw light upon the problems of normal human psychology. Suppose, for instance, that a man, blind from his birth, is rendered able to see by a surgical operation. He must learn to use his eyes, as a child learns to walk. And the gradual perfecting of his vision, the mistakes and confusions to which he is liable, all the details of his visual education, form a storehouse of facts upon which the psychologist can draw when he seeks to illustrate the development of the perception of space in the normal mind,—the manner in which we come to judge of the distance of objects from ourselves

and from one another, of their direction, and of their size and shape. Instructive, also, are those forms of mental unsoundness which consist in the derangement of a single group of processes. The various types of morbid fear — agoraphobia, the fear of being alone in open spaces ; neophobia, the fear of everything that is new ; phobophobia, the nervous dread of being afraid — are only exaggerated forms of experiences that most of us have had. The sanest man will feel lost when he passes, suddenly, from a quiet country life to the bustle of a large town ; we are all a little timid when we enter a strange community ; we have all been afraid that on such-and-such an occasion we shall show our nervousness. Similarly, the self-importance of paranoia is merely an exaggeration of the pleased self-consciousness, the self-complacency, that we often observe in others and, if we are honest, must often detect in ourselves. In all these instances, the strong lines of the caricature may help us to a more correct picture of the normal consciousness.

§ 8. **The Use of Analogy in Psychology.** — We have agreed that the psychologist is not confined to a knowledge of his own mind. Although this is the only mind to which he can directly apply the method of experimental introspection, he can apply the method indirectly to any number of minds. Psychology is based upon the introspections of a large number of trained observers.

But we have gone much farther than this. We have spoken of an animal psychology, a social psychology, and a psychology of the abnormal mind. What, then, is the method to be employed in these branches of psychology ? We cannot ask the animal or the society or the madman to introspect !

Yet, in a sense, this is just what we do. Observation, it will be remembered, implies two things : attention to the phenomena, and record of the phenomena. We

ourselves record mental phenomena, for psychological purposes, in language. This form of record has great advantages: it is flexible, since we have a large vocabulary at our disposal; it is constant, since written or printed reports may be preserved for a long time; and it is easily intelligible, since we are accustomed to the use of words in everyday life. At the same time, language is not the only possible means of expression. Physically regarded, it is a complex bodily movement: spoken language is a movement of the larynx, written language a movement of the hand: and it belongs to the class of movements that we term gestures. We can express our ideas by a grimace or a shrug of the shoulders, as well as by spoken words or a written paragraph.

Now the psychologist argues, by analogy, that what holds of himself holds also, in principle, of the animal, of society, and of the insane. He argues that the movements of animals are, to a large extent, gestures; that they express or record the animal's mental processes. He therefore tries, so far as possible, to put himself in the place of the animal, to find the conditions under which his own movements would be of the same general kind; and then, from the character of his human consciousness, he attempts—always bearing in mind the limit of development of the animal's nervous system—to reconstruct the animal consciousness. He calls experiment to his assistance, and places the animal in circumstances which permit of the repetition, isolation and variation of certain types of movement or behaviour. The animal is thus made, so to say, to observe, to introspect; it attends to certain stimuli, and registers its experience by gesture. Of course, this is not scientific observation: science, as

we said in § 1, implies a definite attitude to the world of experience, and consists in a description of the world as viewed from a definite standpoint. None the less, it is observation, and as such furnishes raw material for science. The psychologist works the raw material into shape; he observes the gesture, and transcribes the animal consciousness in the light of his own introspection.

Roundabout as this method appears, it has nevertheless led, in the hands of skilled investigators, to perfectly definite results. And it is by way of detailed investigation, and by that way only, that the general questions of animal psychology can be finally answered. One of these questions is that of the 'criterion of mind.' How are we to decide whether the animal before us does or does not possess mind? How are we to decide whether it has attended to the stimulus, so that its movement is a gesture movement, or whether it has received the stimulus mindlessly and mechanically, so that the movement is a reflex? An answer now commonly given to this question is that we may assume the presence of mind wherever the animal rapidly adjusts itself to new conditions, quickly learns to get its bearings in a novel environment. The answer is, of course, based upon the analogy of human experience. It is, however, unwise to commit oneself to a criterion of this nature. What is needed is an exhaustive study of all the various modes in which animals do, as a matter of fact, adjust themselves to new conditions. Then the criterion of mind will appear, so to speak, of its own accord.

Another general question is that of the interpretation of the animal consciousness. Shall we assume that this consciousness is always as simple as possible? Or shall we give the animal the benefit of our doubt, take its different forms of behaviour at their face value, and ascribe to it processes of memory, of ideation, of reasoning, that differ from our own only in degree? On this question opinion is sharply divided. Both positions may be supported by the analogy of the human consciousness, since this may be, under very similar circumstances, either extremely com-



plex or surprisingly simple. And so we find one authority laying it down that "in no case may we interpret an action as the outcome of the exercise of a higher psychological faculty, if it can be interpreted as the outcome of the exercise of one which stands lower in the psychological scale";<sup>1</sup> while another authority declares that "we are too ready to adopt simple — unduly simple — explanations of the animals by which we are surrounded."<sup>2</sup> It is, again, unwise to commit oneself to either view. The animal must be subjected to experimental test, under conditions of gradually increasing complexity, and we must find out by actual trial how far it is able to cope with these conditions. Then our principles of interpretation will, also, emerge of their own accord. —

We do, then, make the animals attend to stimuli and report their experiences to us; we do, after a fashion, make them introspect. This would be impossible if introspection implied a reflective attitude towards mind, or a special kind of mental awareness of mental processes. But, as we have seen, introspection is simply observation of dependent experience: it is therefore precisely the sort of observation that an animal can make, if it has a mind at all. Our own task is to do what the animals cannot do: to systematise and interpret the observations in terms of human consciousness.

What holds of the study of the animal mind holds also of social psychology. The introspections made in common by the members of a social group are recorded for us in the forms of speech, in custom and law, in myth and religion. Society has introspected, and has recorded its introspections in these various institutions. It is, obviously, impossible for the psychologist to experiment upon the social mind in any direct way. It is therefore fortunate that nature has made experiments for him. By

<sup>1</sup> C. L. Morgan, *An Introduction to Comparative Psychology*, 1894, 53.

<sup>2</sup> W. Mills, *The Nature and Development of Animal Intelligence*, 1898, 12.

comparing the languages, customs, etc., of different types of human society at all the different levels of human evolution, he is able to repeat, isolate and vary his observations; history furnishes him with a laboratory of social psychology.

It is clear that the study of social psychology requires the use of analogy. It is we, the moderns, who study the myths and customs of primitive man, and we have to psychologise these myths and customs from our own modern standpoint. Hence it is natural to find, in works upon the subject, the same sort of disagreement on general principles that we have noted in the case of animal psychology. And the remedy is the same. We must not hastily adopt a particular view of human evolution, but must patiently examine all the available records; must seek to add to the records by researches among the lower races of mankind; and must then accept the general principles that an exhaustive survey of the facts suggests to us.

Since social psychology is thus a genetic study, a study of human development, it has become customary to speak of its method as a genetic method. In strictness, however, there is no such thing as a genetic method. There is a genetic point of view, as there is a static point of view. We may be interested in the sequence of mental processes, in tracing the course of mind from simple to complex; or we may be interested in the coexistence of mental processes, in unravelling the tangle of a special sort of consciousness. But the difference of interest does not mean a difference of method.

For the psychology of dreaming and of intoxication we have the advantage of direct introspective records. We may also have recourse to experiment. A sleeping person, for example, may be subjected to various kinds of stimulation, and may be aroused, after the stimuli have been applied, to give an account of the dream which they occasioned.



The psychological study of hypnosis is less direct, since the hypnotic subject usually forgets, on arousal, what has taken place during the hypnotic state. We must therefore observe his behaviour during hypnosis, taking care to make our tests as simple and straightforward as possible, and must then seek to reconstruct the hypnotic consciousness on the analogy of the normal waking consciousness. It is, of course, possible to secure introspective reports from hypnotic subjects; but it is still a matter of dispute whether these reports are true records of observations, or do not rather reflect the ideas and opinions of those who are conducting the experiment. The hypnotic subject is extremely suggestible; that is to say, he is exceedingly liable to pick up a hint from the experimenter, and to report as he thinks the experimenter desires or expects him to report.

For the study of the insane mind, we have, in the first place, the utterances and behaviour of insane persons. We have also the opportunity to experiment; the inmates of hospitals may be subjected to systematic tests, the results of which will give us an insight into their mental processes. So far, this branch of psychology is in a backward condition, since we have been more concerned to shelter and, if possible, to cure the insane than to describe the insane consciousness. Certain forms of insanity are, however, of great psychological interest, and we may look confidently to a realisation of this interest in the near future. —

After all, therefore, it is not so absurd as at first thought it seems, to say that we require the animal and society and the madman to introspect. All three may attend; all three may report their experiences. The attention is

likely to be partial, fitful, roving, and the report is likely to be transient, equivocal, imperfect; and so we are compelled, in all three cases, to fall back upon the analogy of our own consciousness. In other words, it is entirely possible to work out, by psychological method, a psychology of the animal, of the social, and of the unsound mind, but it is also very difficult: the psychologist is exposed, at every moment, to the danger of misinterpretation. However, here as elsewhere in science, the pursuit of knowledge furnishes its own corrective. Sooner or later the unfit hypothesis breaks down in face of newly discovered facts.

§ 9. **The Problem of Psychology.** — Science seeks always to answer three questions in regard to its subject-matter, the questions of what, how, and why. What precisely, stripped of all complications and reduced to its lowest terms, is this subject-matter? How, then, does it come to appear as it does; how are its elements combined and arranged? And, finally, why does it appear now in just this particular combination or arrangement? All three questions must be answered, if we are to have a science that shall satisfy the definition of § 1.

It is often said that the answers to the questions 'what' and 'how' give us a description, the answer to the question 'why' an explanation, of the facts with which science deals. This distinction is useful, if we do not make it too rigid. It would be a grave mistake to suppose, for instance, that we may first of all work out an exhaustive description of the world, and then proceed deliberately to explain what we have already described. On the contrary, knowledge grows by a constant give and take between description and explanation; we describe in terms of some theory, that is, in terms of some tentative explanation, and then we rectify

our theory in the light of the observed facts ; and so on, over and over again. The distinction is thus logical only ; it does not point to two successive stages in the history of the special sciences.

To answer the question 'what' is the task of analysis. Physical science, for example, tries by analysis to reduce the world of independent experience to its lowest terms, and so arrives at the various chemical elements. To answer the question 'how' is the task of synthesis. Physical science traces the behaviour of the elements in their various combinations, and presently succeeds in formulating the laws of nature. When these two questions have been answered, we have a description of physical phenomena. But science enquires, further, why a given set of phenomena occurs in just this given way, and not otherwise ; and it answers the question 'why' by laying bare the cause of which the observed phenomena are the effect. There was dew on the ground last night because the surface of the earth was colder than the layer of air above it ; dew forms on glass and not on metal because the radiating power of the one is great and of the other is small. When the cause of a physical phenomenon has thus been assigned, the phenomenon is said to be explained.

So far, now, as description is concerned, the problem of psychology closely resembles the problem of physics. The psychologist seeks, first of all, to analyse mental experience into its simplest components. He takes a particular consciousness and works over it again and again, phase by phase and process by process, until his analysis can go no further. He is left with certain mental processes which resist analysis, which are absolutely simple in

nature, which cannot be reduced, even in part, to other processes. This work is continued, with other consciousnesses, until he is able to pronounce with some confidence upon the nature and number of the elementary mental processes. Then he proceeds to the task of synthesis. He puts the elements together, under experimental conditions: first, perhaps, two elements of the same kind, then more of that kind, then elementary processes of diverse kinds: and he presently discerns that regularity and uniformity of occurrence which we have seen to be characteristic of all human experience. He thus learns to formulate the laws of connection of the elementary mental processes. If sensations of tone occur together, they blend or fuse; if sensations of colour occur side by side, they enhance one another: and all this takes place in a perfectly regular way, so that we can write out laws of tonal fusion and laws of colour contrast.

If, however, we attempted to work out a merely descriptive psychology, we should find that there was no hope in it of a true science of mind. A descriptive psychology would stand to scientific psychology very much as the old-fashioned natural histories stand to modern text-books of biology, or as the view of the world which a boy gets from his cabinet of physical experiments stands to the trained physicist's view. It would tell us a good deal about mind; it would include a large body of observed facts, which we might classify and, in large measure, bring under general laws. But there would be no unity or coherence in it; it would lack that single guiding principle which biology has, for instance, in the law of evolution, or physics in the law of the conservation of energy. In order to make psychology scientific we must not only describe,

we must also explain mind. We must answer the question 'why.'

But here is a difficulty. It is clear that we cannot regard one mental process as the cause of another mental process, if only for the reason that, with change of our surroundings, entirely new consciousnesses may be set up. When I visit Athens or Rome for the first time, I have experiences which are due, not to past consciousnesses, but to present stimuli. Nor can we, on the other hand, regard nervous processes as the cause of mental processes. The principle of psychophysical parallelism lays it down that the two sets of events, processes in the nervous system and mental processes, run their course side by side, in exact correspondence but without interference: they are, in ultimate fact, two different aspects of the same experience. The one cannot be the cause of the other.

Nevertheless, it is by reference to the body, to the nervous system and the organs attached to it, that we explain mental phenomena. The nervous system does not cause, but it does explain mind. It explains mind as the map of a country explains the fragmentary glimpses of hills and rivers and towns that we catch on our journey through it. In a word, reference to the nervous system introduces into psychology just that unity and coherence which a strictly descriptive psychology cannot achieve.

It is worth while, for the sake of clearness, to dwell on this point in more detail. The physical world, the world of independent experience, just because it is independent of the individual man, is complete and self-contained. All of the processes that make it up are bound together as cause and effect; nowhere is there a gap or break in their connection. Now, among the processes that make up this independent world are the processes

of the nervous system. These are linked, as cause and effect, both to one another and also to physical processes, outside the body, which precede and follow them; they have their fixed place in the unbroken chain of physical events; they may themselves be explained, exactly as the occurrence of dew is explained. Mental processes, on the other hand, correspond, not to the whole series of physical events, but only to a small part of them, namely, to certain events within the nervous system. It is natural, then, that mental phenomena should appear scrappy, disconnected, unsystematic. It is also natural that we should seek their explanation in the nervous processes which run parallel to them, and whose causal connection with all the other processes of the independent world ensures the continuity that they so conspicuously lack. Mind lapses every night, and reforms every morning; but the bodily processes go on, in sleep and in waking. An idea drops out of memory, to recur, perhaps quite unexpectedly, many years later; but the bodily processes have been going on without interruption. Reference to the body does not add one iota to the data of psychology, to the sum of introspections. It does furnish us with an explanatory principle for psychology; it does enable us to systematise our introspective data. Indeed, if we refuse to explain mind by body, we must accept the one or the other of two, equally unsatisfactory alternatives: we must either rest content with a simple description of mental experience, or must invent an unconscious mind to give coherence and continuity to the conscious. Both courses have been tried. But, if we take the first, we never arrive at a science of psychology; and if we take the second, we voluntarily leave the sphere of fact for the sphere of fiction.

These are scientific alternatives. Common sense, also, has in its own fashion realised the situation, and has found its own way out. It is precisely because of the incompleteness and disconnectedness of mental experience that common sense constructs a hybrid world, travelling easily from mental to physical and back again, filling up the breaks in the mental by material borrowed from the physical. That way, we may be sure, lies confusion of thought. The truth underlying the confusion is, however, the



implicit acknowledgment that the explanatory principle for psychology must be looked for beyond, and not within, the world of dependent experience.—

Physical science, then, explains by assigning a cause; mental science explains by reference to those nervous processes which correspond with the mental processes that are under observation. We may bring these two modes of explanation together, if we define explanation itself as the statement of the proximate circumstances or conditions under which the described phenomenon occurs. Dew is formed under the condition of a difference of temperature between the air and the ground; ideas are formed under the condition of certain processes in the nervous system. Fundamentally, the object and the manner of explanation, in the two cases, are one and the same.

In fine, just as the method of psychology is, on all essential points, the method of the natural sciences, so is the problem of psychology essentially of the same sort as the problem of physics. The psychologist answers the question 'what' by analysing mental experience into its elements. He answers the question 'how' by formulating the laws of connection of these elements. And he answers the question 'why' by explaining mental processes in terms of their parallel processes in the nervous system. His programme need not be carried out in this order: he may get the hint of a law before his analysis is completed, and the discovery of a sense-organ may suggest the occurrence of certain elementary processes before he has found these processes by introspection. The three questions are intimately related, and an answer to any one helps towards the answers to the other two. The measure of our progress in scientific psychology is our ability to return satisfactory answers to all three.

References for Further Reading<sup>1</sup>

- § 1. Herbert Spencer, *The Genesis of Science*, in *Essays: Scientific, Political and Speculative*, ii., 1891.  
K. Pearson, *The Grammar of Science*, 1900, chs. i., iii.
- § 2. O. Kuelpe, *Outlines of Psychology*, 1909, § 1, 1-7.  
W. Wundt, *Outlines of Psychology*, 1907, §§ 1, 2.
- § 3. G. S. Fullerton, *A System of Metaphysics*, 1904, chs. i., v.
- § 4. W. James, *Principles of Psychology*, i., 1890, 128-144 (for interaction: read with E. B. Titchener, *Were the Earliest Organic Movements Conscious or Unconscious?* in *Popular Science Monthly*, lx., 1901-2, 458-469).  
H. Ebbinghaus, *Grundzüge der Psychologie*, i., 1905, § 4 (for parallelism).  
C. A. Strong, *Why the Mind has a Body*, 1903, 67-160.  
G. S. Fullerton, *Is Man an Automaton?* in *Popular Science Monthly*, lxx., 1907, 149-156.
- § 5. For the character of mind as process, see W. Wundt, *Philosophische Studien*, x., 1894, 121-124.
- § 6. On observation and experiment, see W. S. Jevons, *The Principles of Science*, 1900, Bk. iv., chs. xviii., xix.  
On introspection, see G. Spiller, *The Mind of Man*, 1902, 15-20, 34-37; W. B. Pillsbury, *A Suggestion toward a Reinterpretation of Introspection*, in *Journal of Philosophy, Psychology and Scientific Methods*, i., 1904, 225-228.
- § 7. W. Wundt, *Outlines of Psychology*, 1907, §§ 19-21.  
R. M. Yerkes, *Animal Psychology and Criteria of the Psychic*, in *Journal of Philosophy, Psychology and Scientific Methods*, ii., 1905, 141-149.  
G. T. W. Patrick, *The Psychology of Football*, in *American Journal of Psychology*, xiv., 1903, 368-381.

<sup>1</sup> The works cited under this heading throughout the book are of various degrees of difficulty, and their point of view is in many cases opposed to that of the author. To avoid confusion of thought, the student is advised to refer to them only after he has read the book through, and has thus formed a clear idea of the psychological system which it outlines. Difficulties and contradictions will then seem less formidable and less vital than they would if encountered at the beginning of his study of mind.

The dates given are those of current editions. Works that have passed through a number of editions are, however, quoted by chapter and section rather than by page, so that earlier editions may be used.



- T. Heller, *Studien zur Blinden-Psychologie*, in *Philosophische Studien*. xi., 1895, 226-253; 406-470; 531-562.
- § 8. C. L. Morgan, *An Introduction to Comparative Psychology*, 1894, 37-47.  
 W. Wundt, *Völkerpsychologie*, i., 1904, Einleitung; also *Sprachgeschichte und Sprachpsychologie*, 1901, § 1.  
 M. F. Washburn, *The Animal Mind, a Text-book of Comparative Psychology*, 1908, chs. i., ii.
- § 9. O. Kuelpe, *Introduction to Philosophy*, 1897, *Psychology*, 55-67.  
 W. James, *Principles of Psychology*, i., 1890, 1-4.  
 H. Münsterberg, *Psychology and Life*, 1899: essay on *Psychology and Physiology*, 35-99.

## NOTE ON THE CLASSIFICATION OF PSYCHOLOGY

The following list of the various subdivisions of psychology is made out on the basis of the distinctions drawn in § 7. We cannot hope to make the list final and complete. But it is well to realise, at the beginning of one's study of mind, how wide and varied is the territory that psychology covers.

### I. PSYCHOLOGY OF THE NORMAL MIND

#### *A. Individual psychology*

- i. *Human psychology*. This may be subdivided into:
1. *General psychology*, or the psychology of the adult civilised man. This is the principal topic of the text-books of psychology: see, for instance, W. James, *Principles of Psychology*. 1890; J. Sully, *The Human Mind*, 1892.
  2. *Special psychology*, or the psychology of the human mind in some other stage than that of adult manhood. Special psychology thus includes infant psychology, child psychology, the psychology of adolescence, the psychology of senility, etc. These psychologies are often written from the genetic point of view.—W. Preyer, *The Mind of the Child*, 1888-9 [*Die Seele des Kindes*. 1900]; G. S. Hall, *Adolescence*, 1904.
  3. *Differential psychology*, or the study of the differences between individual minds. The minds compared may belong to persons of the same race, class, age, sex, etc., or to persons who differ in these respects.—L. W. Stern, *Ueber Psychologie der*

*individuellen Differenzen*, 1900; A. Binet, *L'Étude expérimentale de l'intelligence*, 1903.

4. *Genetic psychology*, which seeks to trace the development of mind from infancy to manhood, and its gradual decay in old age.— J. M. Baldwin, *Mental Development in the Child and the Race*, 1906.
- ii. *Animal psychology*. This may be subdivided, like human psychology, into general, special, differential and genetic psychology. Since the workers in the field of animal psychology have, for the most part, been interested in the problems of mental evolution, animal psychology as a whole is often termed genetic psychology: but this is a misnomer.— E. Thorndike, *Animal Intelligence*, 1898; H. S. Jennings, *Behaviour of the Lower Organisms*, 1906.
- iii. *Comparative psychology*. This is the comparative study, either of various types of animal mind, or of the minds of the animals and of man. It may be general, special or genetic. Like animal psychology, and for the same reason, it is often termed genetic psychology.— C. L. Morgan, *An Introduction to Comparative Psychology*, 1894; W. Wundt, *Lectures on Human and Animal Psychology*, 1896 [*Vorlesungen über die Menschen- und Thierseele*, 1906]; M. F. Washburn, *The Animal Mind*, 1908.

### *B. Collective psychology*

The divisions of this department of psychology are not as yet sharply defined. We may, however, distinguish:

- i. *Social psychology*, which includes the study of the social consciousness, and also the study of the products of the collective mind: language, law and custom, myth and religion.— G. Tarde, *Social Laws*, 1899; J. M. Baldwin, *Social and Ethical Interpretations in Mental Development*, 1906; W. Wundt, *Völkerpsychologie*, 1904–8.
- ii. *Ethnic psychology*, the differential psychology of nations or races.— G. le Bon, *The Psychology of Peoples*, 1898; W. H. R. Rivers and C. S. Myers, *Cambridge Anthropological Expedition to Torres Straits*, 1901–3.
- iii. *Class psychology*, the differential psychology of classes, professions, etc.— E. Tardieu, *Psychologie militaire*, 1898; L. Dauriac, *Essai sur l'esprit musical*, 1904.

II. PSYCHOLOGY OF THE ABNORMAL MIND

A. Individual psychology

- i. *Psychology of deficient and exceptional minds.*—M. Howe and F. H. Hall, *Laura Bridgman*, 1903; C. Lombroso, *The Man of Genius*, 1891 [*L' uomo di genio*, 1894].
- ii. *Psychology of mental derangement*, the study of temporary abnormalities of mind.—A. Maury, *Le sommeil et les rêves*, 1878; A. Moll, *Hypnotism*, 1890; E. Parish, *Hallucinations and Illusions*, 1897; S. de Sanctis, *I sogni*, 1899.
- iii. *Psychology of mental disorder*, the study of the permanently deranged mind.—T. Ribot, *Diseases of Personality*, 1895; G. Störing, *Mental Pathology in its Relation to Normal Psychology*, 1907.

B. Collective psychology

*Psychology of mental derangement.*—J. Jastrow, *Fact and Fable in Psychology*, 1900; S. Sighele, *La foule criminelle*, 1901.

## SENSATION

§ 10. **The Elementary Mental Processes.**—It is very important that we make no mistake as regards the nature and number of the elementary mental processes. For these elements are the simple materials out of which we are to build up our entire psychology. They must, therefore, be various enough and numerous enough to give rise, by their connections, to all the complicated phases of the human mind: to thought and sentiment, to memory and imagination, to emotion and perception. On the other hand, they must be strictly elementary; they must remain unchanged, however persistent our attempt at analysis and however refined our method of investigation. If the list is not complete, we shall be forced presently to smuggle in new elements: and that means bad logic and bad science. If we now pass as elementary any process that is really complex, we are guilty of a sheer blunder, and shall pay for it later on.

Here, however, is a dilemma. The science of psychology is still in the making; and, until it is rounded out and finished off, no final list of the mental elements can possibly be drawn up. We must make a decision in the matter; but we must not be dogmatic: we must stand ready to modify our decision, if the results of future research prove us to be wrong. Such a state of affairs is, perhaps, a little discouraging, since a right choice of elements is of cardinal importance; but it is not unnatural, nor is it dis-

creditable to psychology. All scientific problems require time for their solution; and this problem of the nature and number of the mental elements is comparatively new, — certainly not older than the middle of the last century. So long as mind was looked upon as a substance, a real being, a personal creature, psychology had no more to do than to note down the different powers or faculties or capacities of the mind, as they fell under observation. The list always remained open. Not until mind is regarded as a stream of processes, whose flow is throughout obedient to psychological law, does the problem of analysis become insistent. Besides, this problem can be solved only by help of the experimental method; and the first laboratory of psychology was founded as late as 1879. It is not surprising, then, that psychologists should still disagree as to the mental elements. Every year sees the proposal of some fresh process as candidate for elementary rank; every year brings proof that one or other of the older candidates must, after careful scrutiny, be debarred from competition. And this back-and-forth movement will continue, we must suppose, for many years to come.

There is, nevertheless, beneath all these cross-currents of controversy, a fairly definite trend of psychological opinion in the matter of the elementary processes. The list that we adopt in this book is accepted by a large number of psychologists, and, as a working hypothesis, has so far proved adequate to the composition of the human mind. If it has to be changed in the future, we may be tolerably sure that the change will come by way of addition, and not of subtraction, so that our acceptance of it will give us nothing to unlearn. — We set to work upon the assumption that there are at most three classes of mental ele-

ments; that two of these may, without any hesitation, be considered as sub-classes under a single general heading, even if they may not be grouped outright in a single class; and that all three may, with some show of probability, be viewed as processes of the same ultimate type.

The three classes of elementary processes are known as sensations, images, and affections. Sensations are, of course, the characteristic elements of perceptions, of the sights and sounds and similar experiences due to our present surroundings. Images are, in just the same way, the characteristic elements of ideas, of the mental pictures that memory furnishes of past and imagination of future experience. Sensations and images are so much alike that they are not seldom confused; we shall discuss their relations in detail in § 61. Lastly, affections are the characteristic elements of emotions, of love and hate, joy and sorrow. At first sight, they appear to be essentially different from sensations and images, though a closer examination brings out a number of fundamental resemblances. We shall discuss them in § 69.

It is our business, then, to describe and explain these elementary processes, and to show that, when grouped and arranged in certain uniform ways, they give rise to the different complex processes that constitute human consciousnesses.

We shall have occasion, later on, to say something about various other processes that have been put forward as elementary. Many psychologists, for instance, accept an additional class of relational elements. A quotation from Herbert Spencer will show what is meant. "The proximate components of mind," he writes, "are of two broadly-contrasted kinds—Feelings and the Relations between feelings. [The word 'feelings' here may be taken

to include our sensations, images and affections.] Under an ultimate analysis, what we call a relation proves to be itself a feeling — the momentary feeling accompanying the transition from one conspicuous feeling to an adjacent conspicuous feeling. Notwithstanding its extreme brevity, its qualitative character is appreciable.”<sup>1</sup> These relational processes we discuss in § 140. Again, some psychologists have postulated a conative element, or elementary process of will; others have set thoughts, as elementary processes, alongside of sensations and images. These, too, we discuss, in §§ 127, 139. The great majority of such pretenders may, however, be passed over in silence. They die and are dissected in the pages of psychological magazines, and do not live long enough to be mentioned in text-books.

§ 11. **Elements and Attributes.** — We have taken it for granted that the mental elements may be arranged in groups or classes. It may be objected that, since they are elements, — since they resist analysis, and cannot be reduced to anything simpler than themselves, — we can have no means of grouping them. How is it possible to find degrees of likeness and degrees of difference between absolutely simple things?

The psychologist arranges the mental elements precisely as the chemist classifies his elementary substances. The chemical elements are divided, for instance, into metals and non-metals. The metals have a high power of reflecting light; they are opaque; they are good conductors of heat and electricity; they have high specific gravities. So they are set off, as a group, from the non-metals. These latter, again, include both gaseous and solid elements. That is to say, the chemical elements possess certain prop-

<sup>1</sup> *Principles of Psychology*, 1881, vol. I., pt. ii., ch. ii., § 65. The quotation has been somewhat simplified.



erties or attributes, by means of which they may be distinguished and arranged.

It is just the same with the mental elements. These are simple, it is true, in the sense that they are mental experience reduced to its lowest terms; but they are still real processes, still actual items of mental experience. Hence, like the chemical elements, they show various aspects or attributes, — present different sides, so to speak, — each of which may be examined separately by the psychologist. It is by reference to these attributes that introspection is able to classify them under different headings. —

There is no more agreement in psychology about the attributes of the mental elements than there is about the elements themselves. It is, indeed, probably true to say that there is not so much; the lists given in the different text-books seldom correspond in all details.

Various reasons may be given for this divergence of opinion. It is often said, for example, that the psychologist must remain in doubt as regards the attributes of a mental element because he can never actually isolate the element itself, in order to bring it under separate observation. The human mind is so complex, and the avenues of approach to the human nervous system are so numerous, that he can never reduce consciousness to a single, simple process. Now in strictness this statement is, no doubt, entirely correct. At the same time, it is possible to arrange experimental conditions in such a way that, for all practical purposes, one process and one process only is presented for observation. If we rule out distracting influences, and concentrate the attention upon, say, a particular sensation, then this sensation stands out clear and distinct, and all the rest of consciousness becomes a vague blur of indifferent



processes. Practically, therefore, the psychologist can isolate a mental element, and can, as was said above, examine separately its various aspects or attributes. The reason for difference of opinion in regard to these attributes must be sought elsewhere.

The chief reason lies in the difficulty of deciding what is original in the sensation, inherent in it, constitutive of it, and what is mere accretion. The human nervous system, we must remember, has an immensely long history, is the outcome of long ages of development. The result is that it is full of short cuts ; it is shot through and through with paths of direct connection. When, therefore, we think that we have a bare sensation before us, it is quite possible that we are, in reality, observing a complex process. What appears to be an aspect or attribute of the sensation may, in reality, be a separate process, so habitually and inseparably connected with the sensation in the past as now to seem an integral part of it. Let us take an instance.

We hear two tones, from the deep bass and the high treble. The former sounds voluminous and massive ; the latter sounds small and sharp. Are we to conclude, then, that volume is an original attribute of tones ? that tonal sensations possess a kind of solidity, a vague extension in the three dimensions of space ? Some psychologists accept this conclusion. Others believe, on the contrary, that the volume which attaches to tones is a distinct process, and that it belongs not to hearing but to sight. When we hear a deep tone, that is, we are reminded of things that look large and soft ; and when we hear a high tone, we are reminded of things that look small and hard : there is nothing large or small, soft or hard, about the tones themselves. Here, then, is the difficulty, — in deciding what is inherent

in tonal sensation and what is merely accessory : there is no difficulty in isolating the tones for separate observation.

Another reason may be found in the fact that, the more closely a particular kind of element is studied, the more many-sided is it likely to appear. Hence the specialist in any department of psychology will sometimes claim for his elements a larger number of attributes than the student of general psychology can discover in them. We may again illustrate this difference of opinion by reference to tones. Most of us would be disposed to think that a sensation of tone is characterised, simply and sufficiently, by its pitch, its definite position — high or low — upon the tonal scale. But the special student tells us that what we take to be a simple attribute of pitch is, in point of fact, the unanalysed resultant of no less than three distinct attributes.

Agreement will come with time ; persistent observation, refining the longer it is continued, will someday settle the questions that we are here discussing. Meanwhile, the important thing is that we keep our minds open, and observe as carefully and impartially as we can. And if there are many occasions when we must speak less positively than we could wish, there is, on the other hand, the comforting reflection that an unfinished science is a good deal more interesting than a science whose facts and laws are already cut and dried.

§ 12. **The Attributes of Sensation.** — A sensation, as the term is used in this book, may be defined as an elementary mental process which is constituted of at least four attributes, — quality, intensity, clearness and duration. There are sensations for which the list of attributes is longer ; but

these four are essential. We will consider them briefly, in the order of mention.

Quality is, so to say, an individual attribute; it is the attribute which distinguishes every elementary process from every other. It is, accordingly, the attribute which gives a sensation its special and distinctive name: cold, blue, salt,  $b^b$ , — these are all names of sensation qualities. Intensity is the attribute to which we refer when we say that a given sensation is brighter or duller, louder or fainter, heavier or lighter, stronger or weaker, than another sensation. In making such comparisons, we think of the sensations as possessing the same quality: both are blue, both are  $b^b$ , both are pressure, both are cold or salt or asafœtida: but these two sensations, of the same quality, lie at two different points upon a finite scale of sensation degrees, which begins at a lower limiting value and rises to a maximum. The more intensive sensation is placed higher up, the less intensive lower down, upon the scale of intensities. Clearness, again, is the attribute which gives a sensation its particular place in a consciousness: the clearer sensation is dominant, independent, outstanding, the less clear sensation is subordinate, undistinguished in the background of consciousness. If, for instance, we are listening to tones in order to decide whether or not they all alike possess the attribute of volume, the sensations are clear; if we are absorbed in work of a different kind, and someone is experimenting with tones in the next room, we still have the tonal sensations, but they are obscure. Lastly, duration is, as its name implies, a temporal attribute; it is the attribute which makes the course of a sensation in time — its rise, poise and fall as process in consciousness — characteristically different from the course of another sensation.

All sensations, without exception, possess the attributes of quality, intensity, clearness and duration. The list may be lengthened in two ways: by the splitting up of an attribute which has hitherto been regarded as simple, and by the discovery of attributes altogether different from the essential four.

On the first point, we have already remarked that what appears to ordinary observation as a simple attribute of quality may turn out, on closer examination, to be the unanalysed resultant of two or three distinct attributes. This is the case with tones, and also, as we shall see presently, with colours. The second point is best illustrated by reference to sight and touch. Sensations of colour are spread out areally into length and breadth; they appear as spatial extents. And this attribute of extent is part of their very constitution. Reduce the colour to a pin point, and it still occupies space; think away the spatial attribute, and the sensation has disappeared with it. So with pressures: set the point of a stiff horse-hair lightly down upon the skin, and the sensation is extended, diffused over a mental area. Certain sensations, then, have this attribute of extent; others, as odours and tones, show no trace of it. We come back to these facts, in detail, when we discuss the various classes of sensations.

The longest list of attributes is possessed by colour sensations. What we ordinarily term the quality of colour is the resultant of three qualitative attributes: colour-tone or hue, light-tone or tint, and colour-depth or chroma. To these three must be added the intensive attributes of intensity proper, clearness, duration and extent.

It is to be noted that, in certain cases, the concurrence of two or more attributes gives rise to what we may call an

attribute of the second order. Thus, certain sensations have been credited with an attribute of insistence. They are self-assertive and aggressive; they monopolise consciousness, as a forward and pushing guest will monopolise conversation at a social gathering. We speak of the penetratingness of odours like camphor and naphthaline; of the urgency or importunity of certain pains or of the taste of bitter; of the obtrusiveness or glaringness of certain lights and colours and tones. This character of insistence is, however, not a new primary attribute of the sensations. It is the resultant of clearness conjoined with quality, or with intensity, or with quality and intensity together.

§ 13. **The Classification of Sensations.** — Introspection leaves no doubt that the sensations, regarded as qualitative processes, fall into a number of separate groups. All colour sensations, for instance, go together; all tonal sensations go together. Colours, again, are more akin to greys, and tones to noises, than are colours to tones. This kinship between certain sense qualities means, in general, that the sensations fall into continuous series, so that one can pass from quality to quality as if along a straight line, without leaving one's path or meeting with a gap or interruption. It is possible to travel in this way from bass to treble, through the middle tones of the scale, or from red to white, through a series of pinks: it is not possible to travel from a colour to a tone.

We may, then, classify sensations in terms of their introspective resemblances. We may also, with change of standpoint, classify them by reference to the body, since observation has shown that every group of sensations comes to us by way of a definite, specially developed bodily

organ. The sensations of a particular group will then be those whose parallel bodily processes, in spite of difference of detail, have the same general effect within the organism. We may accordingly speak of eye sensations, muscle sensations, etc. Such a list, if completed, would be perfectly accurate.

Finally, we may classify sensations by reference to the stimuli which arouse them. Sensations at large fall into two principal groups, according as their stimulus is external, originating outside the body, or internal, originating within the body. Light, the stimulus to vision, is an external stimulus; muscular contraction, the stimulus to muscular sensation, is an internal stimulus. We therefore distinguish between sensations of the special senses, which are stimulated from without, and organic sensations, whose stimulus consists in a changed state of the internal bodily organs from which they come.

Not all the sense qualities that are ordinarily grouped together fall into continuous series, like the series of colours and tones. We naturally think, for example, of the sensations of pressure and temperature as forming a group of qualities, although no transition is possible from one quality of the group to another. We naturally think, again, of the sensation of warmth as very closely related to the sensation of cold, although there are no qualities which join these two sensations, and although their sense organs are distinct. It might seem, then, that the sensations of pressure and temperature are bracketed together simply by reference to the skin as their common organ, and the sensations of warmth and cold simply by reference to their common stimulus. Nevertheless, there is a real introspective resemblance between them. Pressure is more like warmth and cold than it is like tone or colour; and we do not feel the jar, in passing from cold to warmth, that we should feel if the disappearing cold were followed by a low tone or a



faint odour. The kinship which introspection finds among these sensations is, in the last resort, a matter of conscious context: the sensations from part of consciousnesses of the same pattern, make the same sort of connections in consciousness, are more or less interchangeable in consciousness.

In making out a list of the various departments of sensation, we are at times compelled to speak in terms of sense-organ or of stimulus, for the simple reason that the sensations themselves have not received a name. There is, for instance, no name to designate the peculiar quality of the sensation aroused by contraction of striped muscle. Language has developed at the command, not of theoretical interest, but of practical convenience; and there has been no pressing reason for the naming of all the separate sensations. Even in the case of colours, we have terms like violet and orange, the names of flower and fruit, alongside of the much older terms blue, red, etc.; and to denote a particular tone we have to use such clumsy expressions as 'the *c* of the thrice accented octave.'

#### References for Further Reading

- §§ 10, 11. E. B. Talbot, *The Doctrine of Conscious Elements*, *Philosophical Review*, iv., 1895, 154.  
 M. F. Washburn, *Some Examples of the Use of Psychological Analysis in System-Making*, *Philosophical Review*, xi., 1902, 445.  
 E. H. Hollands, *Wundt's Doctrine of Psychical Analysis and the Psychical Elements, and Some Recent Criticism: 1. The Criteria of Elements and Attributes*, *American Journal of Psychology*, xvi., 1905, 499.  
 O. Kuelpe, *Outlines of Psychology*, 1909, § 40 (elementary quality of will).
- § 12. M. W. Calkins, *Attributes of Sensation*, *Psychological Review*, vi., 1899, 506.  
 M. F. Washburn, *Notes on Duration as an Attribute of Sensations*, *ibid.*, x., 1903, 416.  
 M. Meyer, *On the Attributes of the Sensations*, *ibid.*, xi., 1904, 83.  
 E. B. Titchener, *Lectures on the Elementary Psychology of Feeling and Attention*, 1908, Lecture i.

It should be said that current works on psychology differ, not only as regards the nature and number of the elementary mental processes and their attributes, but also as regards the principles and aims of psychological analysis in general. The fact is not surprising, when we remember that the fundamental questions treated in the Introduction — the questions of subject-matter, method and problem of psychology — are still in debate. The reader may compare with the discussion of the preceding paragraphs G. F. Stout, *The Groundwork of Psychology*, [1903] ch. iii. ; C. H. Judd, *Psychology: General Introduction*, 1907, ch. iv. He should, nevertheless, look for underlying agreements rather than for superficial differences. Judd's preface, for instance, opens with the sentence: "There is very general agreement as to the main topics which must be treated in a text-book on psychology."



## THE QUALITY OF SENSATION : VISION

§ 14. **The Visual Qualities.** — It needs but a casual glance at our surroundings, indoors or out, to assure us that the world of vision comprises a very large number of sense qualities. Besides all the wealth of colour, there is the whole scale of light, from the most brilliant white to the deepest black. Both alike are qualitative systems: black, white and grey, red, yellow, green and blue, — one and all are qualities of sensation, individual and elementary mental processes. To a certain extent, the sensations of light and of colour are independent of each other: a landscape or a coloured painting may be translated, by photography, into an arrangement of blacks, whites and greys. They are also, however, closely related. We speak of certain colours, without hesitation, as being darker or lighter, that is, nearer black or nearer white, than other colours; and we meet with colours of all grades or degrees, from the full quality, the deep red or rich green, to the merest tinge which is but a step from grey.

If we look, first, at the sensations of light, we find that they form a single linear series, extending from white through the lighter, neutral and darker greys to black. Language has very few words to denote the qualities of this series. We speak of black, for instance, as if it were a single quality. But glance, in succession, at black cardboard, black cloth, black velvet, and the black of a comparatively lightless space, — say, the blackened interior of

a long pasteboard tube. You realise at once, not only that these four blacks are qualitatively different, but also that their differences are quite considerable, so that there must be several intermediate blacks between the successive terms of the series. The same thing holds of white. Lay upon the window-sill a sheet of white paper, and on this place a cover-glass, silvered on the under side, in such a position that the glass reflects a patch of uniformly bright sky. The reflected light is astonishingly white, and the white of the paper seems, by comparison, greyish. There are in all, if we count up the distinguishable whites, greys and blacks, between six and seven hundred qualities of light sensation.

The system of colour sensations is less simple; the colour qualities cannot be arranged upon a single straight line. Let us take, as the arrangement of colours with which we are most familiar, a chart or a projection of the solar spectrum, and let us work through it, from the left or long-wave to the right or short-wave end. On the extreme left we have the quality of red. As we travel to the right, the red takes on more and more of a yellowish tinge, until it passes through orange to a pure yellow. Here, then, we have a linear series of qualities, precisely similar to the series of light sensations. Now, at yellow, we change our direction. The yellow gradually becomes tinged with a new quality, that of green; it passes through yellow-green to a pure green. Here is a second line of qualities. Again we change our direction; the green becomes more and more bluish, until it passes through blue-green to a pure blue. Here is a third line of qualities. Once more we change our direction. This time, however, the tinge that our initial quality takes on is not new; the blue becomes

increasingly reddish, as we travel to the right-hand end of the spectrum. Here is a fourth line of qualities, but a line which in the spectral series is left incomplete at violet. If we continue it, by adding the purples and carmines, we are finally brought back to our starting-point, — the red of the extreme left. We notice, however, that this red is not, in reality, the starting-point of a psychological colour-line; it is not a pure red, but an orange-red; the red that stands at the beginning of the red-yellow line lies outside the spectrum, toward the carmines. x M

All the colours that can be distinguished upon these four lines are ultimate qualities of visual sensation. We speak, it is true, of pure red and of orange-red; but these terms merely indicate the position of the qualities upon a colour-line: pure red comes at the beginning, orange-red towards the middle of the line. No orange-red can be analysed, by introspection, into a red and an orange. The lines themselves, and with them the system of colour qualities, are most simply arranged in the form of a square, with *R*, *Y*, *G* and *B* at the four corners.

So far, then, we have a single straight line to represent the sensations of light, and four straight lines, forming the closed figure of a square, to represent the sensations of colour. But so far, also, we have dealt with sensations of colour only under one aspect, — that of colour-tone or hue. here  
Colours, as was said above, differ further from one another as darker and lighter. Thus, in the spectrum, yellow is undoubtedly the lightest, and violet the darkest colour. Fin  
Here, then, is a second attribute of colour, the attribute of light-tone or tint, in virtue of which a sensation of colour may be matched or equated with a sensation of light. Let us assume that all the hues upon the lines of our colour-

square are of the same tint, and that this tint is that of a grey situated midway between white and black. Then, if the line of light sensations is erected as a vertical, the four colour-lines will lie about it in the horizontal plane, and at the level of this middle grey. All the lighter reds, or pinks, will stand in order above the point *R*, opposite the particular light greys to which their tint corresponds; all the darker reds will stand in order below *R*, opposite the dark greys to which their tint corresponds; and so with the lighter and darker *Y*, *G* and *B*. The vertical line, which represents the whites, greys and blacks, is thus surrounded by a square tube, whose walls are made up of all the hues in every possible variety of tint.

Suppose, now, that a line is drawn from some point on the wall of the tube to the corresponding point upon the vertical line: say, from the point *R* to the middle grey. The sensations that lie upon this new line form a series of the same hue and the same tint; but they differ in respect of a third attribute, that of colour-depth, or degree of saturation, or chroma. The red at *R*, which is farthest out from the corresponding grey, is a rich, full, deep red; it contains all the red that a visual sensation can contain, just as a saturated solution in chemistry contains all of the dissolved substance that it can contain; it shows the attribute of chroma at a maximum. As we proceed inwards, towards grey, the reds become less saturated, more washed-out; their chroma decreases and finally, when the grey is reached, entirely disappears.

As these chromatic lines may be drawn from any point upon the square shell to the corresponding point upon the vertical, our representation of visual sensations becomes a solid figure, a square prism. In actual observation, how-

ever, the lines are not all of the same length; they are longest for hues of a middle tint, shortest for hues of very dark and very light tints. There are, obviously, but few intermediate steps between a very dark blue and the corresponding greyish black, or between a very light yellow and the corresponding greyish white. The square prism thus becomes a double pyramid. At the two poles stand the extremes of white and black; upon the vertical axis, between the poles, are arranged the remaining sensations of light. Round the base of the figure lie all hues of a middle tint and of maximal chroma. Between base and poles lie the same hues in all their further variety of tint; all are still of maximal chroma, though the chromatic maximum decreases steadily, above and below. If we cut into the pyramid, from any point on the outside to a corresponding point upon the axis, we lay bare a series of sensations of the same hue and tint, but of varying chroma.

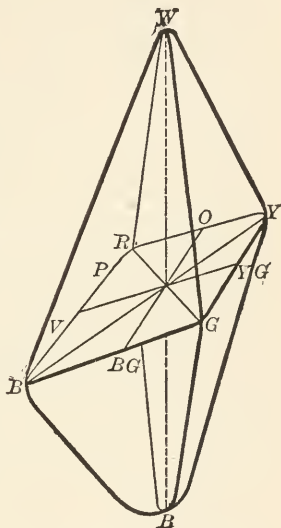

FIG. 2. The Colour Pyramid.

The double pyramid, then, as drawn in Fig. 2, embodies the two systems of visual sensation, sensations of light and sensations of colour, and shows these systems both in their mutual independence and in their mutual relations. There are at least a hundred and fifty distinguishable hues round the base. In counting up the whole number of visual sensations we must, however, take account also of

differences in tint and in chroma. These are ultimate differences: a pink is no more analysable by introspection

into a red and a white than an orange-red is analysable into a red and an orange. All in all, the full tale of the visual elements cannot fall far short of thirty-five thousand.

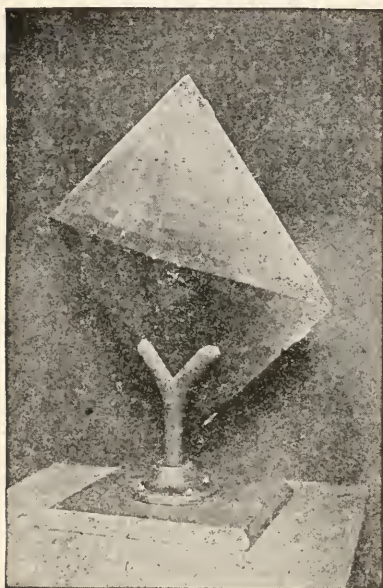

FIG. 3. Demonstrational Colour Pyramid.—*American Journal of Psychology*, xx., 1909, 15.

§ 15. **Visual Stimulus and Visual Sensation.**—

The trains of ether waves which constitute light, in the physical sense, differ in three ways: in wave-length, in wave-amplitude or energy, and in wave-form or composition. In general, these three aspects of the ether waves correspond to the

three attributes of colour sensation, — hue, tint and chroma. At the red end of the spectrum, the light-waves have a length, roughly, of 700  $\mu\mu$ ; at the violet end a length, roughly, of 400  $\mu\mu$ ; and the intervening hues are correlated with intermediate wave-lengths. If we increase or decrease the energy of these waves, within certain limits, the colours as a whole become lighter or darker, — there is a change of tint; but the distribution of hues, and the relative degrees of tint and chroma, remain unchanged. Lastly, the fact that the spectral hues possess a high



chroma, while the colours that we see in nature and art are less saturated, is due to the relative simplicity of waveform in the one case and its relative complexity in the other. These are, however, only general correspondences. In detail, the relation between visual stimulus and visual sensation is very far from simple.

There is, indeed, one case—the case of the sensation black—in which there seems, at first thought, to be no relation at all. It is often said, paradoxically, that the stimulus to black is the absence of physical light. If this were true, black would stand apart from all the other visual qualities. But, on the one hand, what we see in the absence of light is not black. ‘In the night all cats are grey’; and the absence of light means, in point of fact, that our surroundings appear in a neutral grey. On the other hand, we can see black only in a good light; so that the sensation of black, like the after-images and contrast-sensations of which we speak in § 18, is indirectly, although not directly, dependent upon the presence of physical light. We discuss the question of its origin in § 22.

Black is, of course, a positive sensation; as it is not due to the absence of light, so it does not represent the absence of visual sensation. To suppose that the blind live in darkness is altogether wrong, because it is to suppose that they are able to see. Blind persons see things, as Helmholtz puts it,<sup>1</sup> in the same way in which we ourselves see what is behind our backs: that is to say, they do not see them at all.

§ 16. **The Dependence of Visual Sensation upon Wavelength and Energy of Light.**—In general, as we have

<sup>1</sup> H. L. F. von Helmholtz, *Handbuch der physiologischen Optik*, 1896, 324.

said, change in the wave-length of physical light means change in the hue of colour sensation. This statement must now be qualified in three ways.

① First, we find by reference to the spectrum that the correspondence of wave-length and hue is not uniform throughout the colour series. At the two ends, in *R* and *V*, we may travel for a considerable distance without noticing any marked change of hue. If, on the other hand, we look at the regions on either side of *Y*, or at the *BG* region, we see at once that a very large number of hues is there packed into a very small space. Secondly, we find that difference of wave-length brings with it a difference of chroma. The most saturated colours of the spectrum are *R* and *B*; the least saturated are *Y* and *BG*. Chroma, therefore, depends upon wave-length as well as upon wave-form. Thirdly, we find that change of wave-length brings with it a change of tint. We have already remarked that *Y* is the lightest and *V* the darkest colour of the spectrum. Now the energy of the light-waves decreases continuously from the long-wave to the short-wave end;<sup>1</sup> so that, if tint depended solely on energy or wave-amplitude, *R* and not *Y* should be the lightest colour, and *B*, as compared with *R*, should be much darker than is actually the case.

\* In the same way, change in the energy of physical light may change, not only the tint, but also the hue and the chroma of colour sensations. If the energy of the light-waves which form the spectrum is greatly increased, the

<sup>1</sup> This statement holds of the dispersion spectrum of an artificial light, such as is usually observed in psychological laboratories. In the diffraction spectrum of sunlight—what physicists term the ‘normal’ spectrum—the maximum of energy is in the blue.



hues are reduced to two, Y and B, both of light tint and low chroma. The *R*, *O* and *YG* of the original series become lighter and yellower; the *BG* and *V* become lighter and bluer; *G* becomes simply lighter, and finally passes into a light grey. If the energy is greatly decreased, the hues are reduced to three, *R*, *G* and *BV*, all of dark tint and low chroma. At the same time there is a marked change in the relative distribution of tint throughout the spectrum: all the colours are darker, but the position of the relatively lightest tint moves from *Y* to *G*,—so that the long-wave end is darkened, and the short-wave end lightened, in comparison with the ordinary spectrum. This shift of tint with decrease of energy is called, after the Austrian physiologist who first observed it, the Purkinje phenomenon.<sup>1</sup>

The Purkinje phenomenon appears most clearly when the energy of the spectrum has been so far diminished that the colours fade out altogether, and only a series of sensations of light is left. It appears, in any case, only if the energy of light is decreased over the whole field of vision; it is not enough to reduce the energy of the spectrum alone. You may get an idea of it by laying pieces of red and blue paper side by side, and observing them first in ordinary diffuse daylight and then through a pin-hole in a card. Or if you watch the reds and blues of a carpet, as twilight comes on, you will notice that the reds quickly become dark grey or black, while the blues change into a silvery blue-grey. This aspect of the phenomenon, in which it depends upon the general illumination of our surroundings, is dealt with in §§ 19, 22.

§ 17. **The Dependence of Visual Sensation upon Composition of Light.**—In tracing out the dependence of visual sensation upon the form or composition of light-waves, we

<sup>1</sup> J. Purkinje, *Beobachtungen und Versuche zur Physiologie der Sinne*, ii., 1825, 109.

may most conveniently employ the colour-mixer, with compound discs of the sort mentioned in § 6. Everyone knows that a glowing match, whirled round in the air, is seen as a fiery circle: the effect produced upon the eye by the moving stimulus persists for a time, in what is termed the positive after-image, until the stimulus comes back again to the same point. This is the principle which underlies the use of the rotating discs. It is, further, a law of physiological optics that if such particoloured discs are rotated at a rate of speed sufficient to prevent flicker, the resulting impression upon the eye is the same as it would be if the physical light, reflected from the several sectors, were spread uniformly, layer on layer, over the whole disc-surface.<sup>1</sup> From this point of view, then, the use of the discs is as safe as it is convenient. Whether we may argue from the results obtained with the discs to the results obtainable with other forms of stimulus, — whether, more especially, we may argue from the disc-colours to the pure lights of the spectrum, — is a question which experiment must decide. We return to it presently.

The facts to be considered in this section may be grouped under three laws, which are known as the laws of colour mixture. The first law states (1) that for every colour there may be found another, antagonistic or complementary colour, which if mixed with it in the right proportions produces a sensation of light, and if mixed in any other proportions a colour sensation, of low degree of chroma and of the hue of the stronger component. An-

<sup>1</sup> This law, called Talbot's law, was first propounded in 1834 by the physicist W. H. F. Talbot, one of the inventors of photography (*The London and Edinburgh Philosophical Magazine and Journal of Science*, series 3, v. 328 ff.).

tagonistic colours, in this sense, are carmine and bluish green, red and verdigris, orange and greenish blue, yellow and blue, yellowish green and violet, green and purple.

The second law states (2) that the mixture of any two colours which are not antagonistic produces a colour sensation of intermediate hue; this hue varies with the relative amounts of the two component colours, and the chroma varies with their nearness or remoteness in the colour series. Thus, a mixture of *R* and *B* will give violet, purple or carmine, according to the amounts taken; and the

(2)  
non-  
com-  
pato  
inter-  
medial  
line  
N.B.

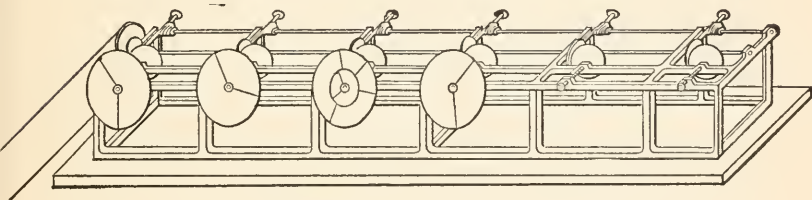

FIG. 4. Demonstrational Colour Mixer, for six sets of discs.

mixture of *R* and *Y* will give an *O* of relatively low, that of *RO* and *OY* an *O* of relatively high chroma.

These two laws are, evidently, laws of the same order; they sum up observations of the same general kind. The third law takes us a step farther and shows the effect of mixing, not single colours, but colour mixtures. It is sometimes termed Newton's law of colour mixture, since it is implicit in his theory of the composition of light.<sup>1</sup> We may formulate it as follows: (3) if two colour mixtures arouse the same sensation of light or colour, then a mixture of these mixtures will also arouse that sensation. If, for instance, the grey produced by a mixture of car-

(3)  
mixture  
sensat  
prod. &  
but

<sup>1</sup> I. Newton, *Opticks: or, A Treatise of the Reflections, Refractions, Inflexions and Colours of Light*, [1704] bk. i., pt. ii., props. 4-6.

things equal to something are equal to each other.

mine and bluish green is the same as that produced by a mixture of red and verdigris, then this grey will also result from the mixture, in the original proportions, of all four colours. — This third law enables us to answer in the affirmative the question, raised above, whether it is legitimate to argue from our disc-colours to other forms of visual stimulus, and especially to the pure lights of the spectrum.

The answer is reached by way of the corollary that any unsaturated colour may be produced by mixture of a saturated colour with grey. The disc-colours are relatively unsaturated colours; they are compounded, physically, of a number of different colours, with some one colour (or some small group of neighbouring colours) in the ascendant. Now the first law declares that the mixture of complementaries produces grey. By the third law, which asserts that all colour mixtures have a constant mixing value, any grey whatsoever may be considered as the result of mixture, in the right proportions, of some pair  $x, y$  of complementary colours. If  $y$  is present in excess, then by the first law we obtain a colour sensation of low chroma and of the hue of  $y$  itself. Hence all that we have to do, in order to produce a particular unsaturated colour, is to search among the saturated colours for the fitting  $y$ , and, having found it, to add a certain amount of grey. This means, however, that our disc-colours may be regarded as spectral colours mixed with various amounts of white light, and therefore that our demonstration of the three laws holds for the spectrum as well as for coloured papers.

There are other important corollaries to these laws. Thus, it follows from the first and second, taken together, that the mixture of three colours, every pair of which embraces the complementary of the third, will give colour sensations of every possible hue, and of all possible degrees of chroma from a certain maximum to zero. Take, for example,  $R, G$  and  $V$ . The mixture of  $R$  and  $G$  will, by the second law, give any hue from the  $O, Y$  and  $YG$  regions; the mixture of  $G$  and  $V$  will give  $BG$  and  $B$ ; the mix-

ture of  $V$  and  $R$  will give  $P$  and  $C$ . Further, the complementary of  $V$  lies between  $R$  and  $G$ ; that of  $R$  between  $G$  and  $V$ ; and that of  $G$  between  $V$  and  $R$ . Hence, by a fittingly proportioned mixture of these three colours, it is possible to obtain a colour sensation of any required hue, and of any degree of chroma that is lower than that of the components. Similar triads of colours are  $R, Y, GB$ ;  $O, G, V$ ;  $P, YG, BG$ ; etc. — This is a useful corollary to us, since it is seldom that the disc-colours are exactly complementary. Hence, to demonstrate the complementarism of  $C$  and  $BG$ , we take three coloured papers,  $C, B$  and  $G$ , and vary the proportions of the sectors until we find a  $BG$  that is antagonistic to the given  $C$ ; and so on with other complementary pairs.

It follows, again, from the third law, as we have formulated it above, that colour-equations are independent of the energy of the physical stimulus. Suppose, for instance, that we have matched a grey derived from  $C$  and  $BG$  to a grey derived from  $B$  and  $Y$ . Now assume that the energy of these greys is doubled or tripled. This is the same thing as assuming that we have made the match two or three times over, and then added the greys together, mixed each grey once or twice with itself. The resulting double or triple greys ought, by the law, to match as well as the original, single greys. Here, however, we may come into conflict with the Purkinje phenomenon. If the equation is first made for a low degree of light-energy, and this energy is then considerably increased, the  $B-Y$  grey will evidently appear lighter than the  $C-BG$  grey. If, contrariwise, the equation is first made for a moderately high degree of light-energy, and the energy is then greatly diminished, the  $C-BG$  grey must appear lighter than the  $B-Y$  grey. And for certain shifts of energy the change of tint will be accompanied by a change of hue. Neither this corollary, therefore, nor the third law itself, in so far as it involves the corollary, can be regarded as valid under all conditions.

§ 18. **The Dependence of Visual Sensation upon the Time and Space Relations of Stimulus.** — The quality of visual sensation is dependent not only upon the wave-length, wave-

amplitude and wave-form of light, but also upon the time during which the waves affect the eye and upon their distribution in space. Under the former heading, we have to consider the facts of adaptation and of negative after-images; under the latter, the facts of light and colour contrast. —

When the lamps are first lighted in the evening, we clearly realise that the illumination is not white but reddish-yellow. As time goes on, however, this colour disappears, and the objects about us look as they would look in a really white light. In ordinary language, we have grown accustomed to the artificial light; in technical terms, adaptation has set in. The law of adaptation is that all sensations of colour tend towards neutrality, and all sensations of light towards a middle grey. Adaptation may be either general, extending over the whole field of vision, or local, extending over some part of the field to which our gaze is constantly directed.

The course of general adaptation to colour may be followed by help of an optician's trial frame and a set of coloured glasses. If, for instance, you wear a pair of yellow glasses even for five minutes, you will find that adaptation has gone surprisingly far. Adaptation to dark and light is never so complete as adaptation to colour: the grey that you see after waking from sleep in a dark room and the grey that you see out of doors on a dull winter's day when the ground is covered with snow are distinctly different, the one lying on the black and the other on the white side of the middle grey. Nevertheless, there is a definite approach to this grey; after you have worn 'black' glasses for a few hours, it is difficult to believe that the world looks darker than it did before you put them on.

Local adaptation may be demonstrated by the apparatus shown in Fig. 5. Gaze steadily, say for 1 min., at the button which lies at the centre of the line of junction of black and white. You soon



see grey films or clouds, which appear first along this line and gradually spread, to right and left, over the whole surface. On the black, the cloud is dark and slowly lightens; on the white, it is light and slowly darkens. Both clouds are strongest at the centre, weaker towards the periphery. (The lines of brilliant white and intense black, that flash out from time to time, are irrelevant to the present observation; they are due to involuntary slips of fixation.) — The black and the white are, evidently, tending both alike towards a middle grey. Indeed, if the gaze is maintained for a sufficient length of time, their difference disappears, and the entire surface is seen as a uniform grey. Similar tests may be made with colours.

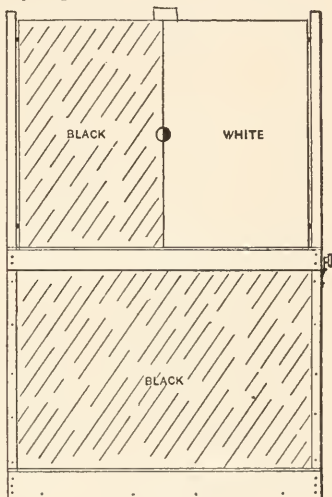

FIG. 5. Adaptation Frame.

It is plain that this law of adaptation may be brought into relation with the laws of colour mixture. To say that, under adaptation, all sensations of colour tend towards neutrality is equivalent to saying that, as time goes on, every colour in the field of vision is mixed with an increasing amount of its antagonistic colour. To say that, under adaptation, all sensations of light tend towards a middle grey is equivalent to saying that, as time goes on, the blacks in the field of vision are mixed with increasing amounts of white, and the whites with increasing amounts of black. Adaptation to colour suggests the first, adaptation to light suggests the second law of colour mixture.

Let us turn, now, to the after-effects of adaptation.

When you come out into the daylight from a matinée performance, everything looks curiously bluish; when you pass from daylight into a darkened room, everything is oppressively black. Very soon, of course, the blue wears off and the black clears up; a novel adaptation is in progress. But the immediate after-effect of general adaptation is always this contrary trend of vision: if you were yellow-adapted, you are now blue-sighted; if green-adapted, now purple-sighted; if dark-adapted, now light-sighted.

The same thing holds of local adaptation. If, by steady fixation, you have brought a patch of colour to disappearance, and the colour stimulus is then removed, you see in place of it a patch of the antagonistic colour, a negative after-image. A yellow stimulus gives a blue after-image; a green stimulus, a purple after-image; a black stimulus, a white after-image.

The after-effect of general adaptation may be demonstrated with the coloured spectacles. When, for instance, the yellow glasses are taken off, all the blues in the field of vision look extremely saturated, all the yellows look whitish, and the other colours appear as if mixed with blue.

To demonstrate the negative after-image, we may continue the observation made with the adaptation screen (Fig. 5). If, at the end of the 1 min., the half-black and half-white card is allowed to fall, and there is shown in its place a background of uniform grey, the observers will see an intense black where they previously saw white, and a brilliant white where they previously saw black. (The black and white lines, spoken of above, owe their depth and brilliancy to the fact that, as fixation slips, the white edge falls upon a black-adapted part of the retina, and conversely: the white is thus seen with a white-sighted eye, and the black with a black-sighted eye.) After-images of colour may be demon-



strated by the apparatus shown in Fig. 6. A disc of coloured glass is fixated, say, for 30 sec. Then a grey screen is dropped between glass and lamp, and the after-image develops, in the antagonistic colour, upon this screen.

It is a little puzzling that, in all these phenomena of adaptation, black and white should behave, in the sphere of sensations of light, as complementary colours behave in the sphere of sensations of colour. We saw in § 14 that the series of light sensations, white-grey-black, resembles the *R-Y*, *Y-G*, *G-B* and *B-R* series of colour sensations;

and we have just said that the course of adaptation to light suggests, in consequence, the second law of colour mixture. But *Y*-adaptation does not leave us *G*-sighted, nor does *R*-adaptation leave us *Y*-sighted or *B*-sighted: why, then, should white-adaptation leave us black-sighted, and conversely? We seek to answer this question, and so to bring all the facts of adaptation under a single principle, in § 22. In the meantime, we notice that, in the domain of contrast, black and white again appear in the same antagonistic or complementary relation. —

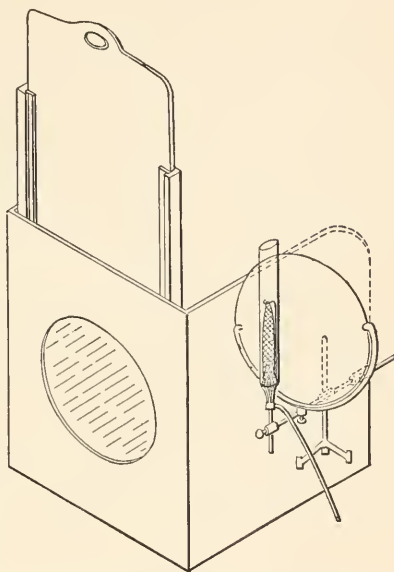

FIG. 6. Wundt's Apparatus for the Observation of Negative After-Images.

76  
vision  
contrast

Contrast is the name given to the effects produced for sensation by the distribution of visual stimuli in space. Every patch of light and colour in the field of vision affects and is affected by all the rest in certain definite ways. The principal laws of contrast—that is, of this reciprocal induction of lights and colours—are as follows. (1) The contrast-effect is always in the direction of greatest opposition; a yellow makes its surroundings bluish, a black makes its surroundings light. (2) The nearer to-

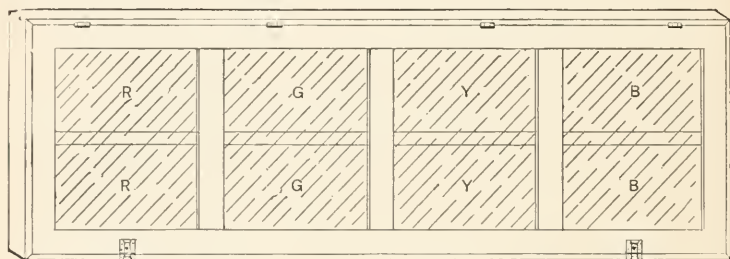

FIG. 7. Contrast Frame.

gether the contrasting surfaces, the greater is the contrast-effect. We may therefore distinguish between marginal contrast, in which the effect is maximal, and surface contrast, in which it is less marked. (3) The contrast-effect is enhanced by the elimination of contours or boundary-lines.—There are two further laws of colour contrast: (4) that the effect is greatest when there is no simultaneous light contrast; and (5) that the effect increases with increase of the saturation of the inducing colour.

A general idea of the phenomena of contrast may be gained from the contrast frame, shown in Fig. 7. The frame contains four sheets of coloured paper,—*R*, *G*, *Y* and *B*. Across the centre of these sheets is laid a horizontal strip of neutral grey paper. Each panel is faced with white tissue, which serves to

bring colour and grey into the same plane, and also to obscure the outline of the grey strip. Under these conditions the grey appears in four different colours, which are complementary to the colours of the sheets, and whose tint varies inversely with the tint of the coloured background. The strip is so narrow that marginal contrast is secured over its whole width.

Very beautiful contrast-effects may be obtained with coloured shadows. Fig. 8 shows two window-slits cut in the wall of a dark room, the one filled with a blue, the other with an ordinary ground glass. A black rod, standing on a table, casts two shadows upon

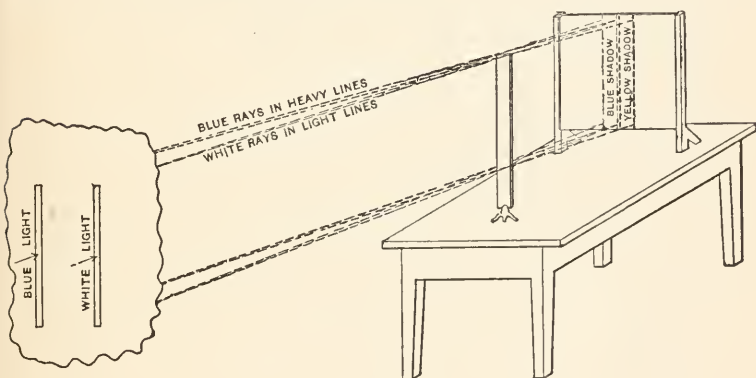

FIG. 8.

a white screen. The farther shadow, due to the white light from the nearer slit, is illuminated by the blue light, and therefore appears blue. The nearer shadow, due to the blue light from the farther slit, is illuminated by the white light, and should therefore, in terms of its physical stimulus, appear light grey. In reality, it appears, by contrast, in the yellow complementary to the blue of its neighbour. — The rod should be moved to and fro, until the shadows are exactly juxtaposed; their lack of definite contour, their narrowness, and their identity of plane, all serve to enhance the contrast-effect. It is, indeed, easily possible, by varying the widths of the window-slits, to give the yellow a higher degree of chroma than is possessed by the blue shadow, so that a naive observer would unhesitatingly declare the blue to be the contrast,

and the yellow the 'real' colour. The bluish tinge of the background shows, of course, that the yellow colour is due to contrast. — Other coloured glasses may be substituted for the blue, with similar results.

It is clear, from all these facts, that the lights and colours of the field of vision, at any given moment, are not exclusively determined by the physical stimuli, the reflected light-waves, which affect the eye. What we see depends, in part, upon contrast; in part, also, upon the preceding adaptation of the eye, general and local. It is clear, further, that contrast and adaptation are in one sense opposed, but in another sense mutually supplementary principles. Contrast is present, throughout the field of vision, as soon as we open our eyes; adaptation requires time. Contrast is a differentiating, adaptation a levelling principle. Hence contrast helps us to discriminate all the separate objects by which we are surrounded, while adaptation prevents our being fatigued or disturbed by their variety after this discrimination has taken place.

§ 19. **Daylight and Twilight Vision.** — The human eye is a single sense-organ, and all its sensations are of one general kind. But it is also an extremely elaborate organ, the final product of a long course of development and differentiation. We must, therefore, consider visual sensation not only in its dependence upon external stimulus, but also in its dependence upon differences of structure and function within the eye. We shall not, in this way, discover any new sense-qualities; but we shall bring the sensations of light and colour into a novel perspective, and shall thus find uniformities which will help us, later on, towards their physiological explanation.

The facts of which we have to take account are, first, those of daylight and twilight vision; and, secondly, those of direct and indirect vision and of colour blindness. The former have already been touched upon, incidentally, in references to the Purkinje phenomenon.

It is, indeed, a curious thing that our sight undergoes a radical transformation as we pass from the light to the dark and back again. So long as the energy of the light-waves that strike the eye is maintained above a certain limit, we have daylight vision. We see the spectrum as a band of colours, with yellow as the lightest tint; we have all degrees of light sensation, from white to black; in a word, our vision is the vision that is summed up in the colour pyramid. When, on the other hand, the energy of the light-waves falls below this limit, we have twilight vision: the spectrum is seen as a band of greys, the lightest of which lies in the region occupied in daylight by the green, and sensations of colour are altogether lacking. Under certain conditions, the two modes of vision overlap. Twilight vision is greatly enhanced by adaptation of the eye to dark; so that, if there is sufficient light for us to distinguish colours, while at the same time the eye is partially dark-adapted, we see the Purkinje phenomenon superposed upon daylight vision. On the other hand, this overlapping is not possible over the whole extent of the retina. At the very centre of the eye, there is no twilight vision, and the Purkinje phenomenon does not appear. So far, then, the two modes of vision are locally separated: while the eye in general is composed, so to say, of two eyes, a nyctalopic and an hemeralopic, a small area in the middle of the retina is permanently hemeralopic.

We said in § 16 that the Purkinje phenomenon might be observed by looking at red and blue papers through a pinhole in a card. It may also be observed by looking at the colours through nearly closed eyelids, or by taking them from a light into a dark room. In all three cases, since the colours are still visible, there is a mixture of daylight and twilight vision ; that is to say, the phenomenon does not appear at once, but only after a little while, when dark-adaptation has gone a certain distance. A similar mixture of the two types of vision occurs as you watch the reds and blues of the carpet in a deepening twilight. If, on the other hand, you go straight from bright daylight into a perfectly dark room, in which is exposed a spectrum of such low energy that no colour can be seen, then, as soon as you are able to observe at all, you observe that this spectrum shows the Purkinje phenomenon. Twilight vision is primarily dependent, not upon dark-adaptation, but upon the reduction of the energy of light. What dark-adaptation does is to make the greys of twilight vision much clearer and stronger than they are without it.

The absence of the Purkinje phenomenon at the centre of the retina can be demonstrated only by aid of refined physical instruments. It is, however, easy to convince oneself that this central area, which in daylight is preferred for all the most delicate uses of vision, is not stimulable by light-waves below a certain limit of energy. Look directly, on some dark night, at a faint star or a distant lamp that is just visible as the eye travels over the field of vision, and the point of light disappears. Shift your gaze ever so little from this direct fixation, and it flashes out again.

We can now understand the exceptions to the third law of colour mixture, mentioned in § 17. Colour equations made in daylight vision will hold in daylight vision : they cease to hold when we exchange this for twilight vision, or when in consequence of dark-adaptation twilight encroaches upon daylight vision.

§ 20. **Indirect Vision and Colour Blindness.** — Under ordinary circumstances, we pay but little attention to the outlying parts of the field of vision. What we want to

see, we look at, and so bring upon the centre of the retina ; and we take it for granted that the visible objects which lie far out in the field, round about this region of direct regard, retain the colours which they show when we turn the eye upon them. Nevertheless, the colour vision of the peripheral retina is very different from that of the centre.

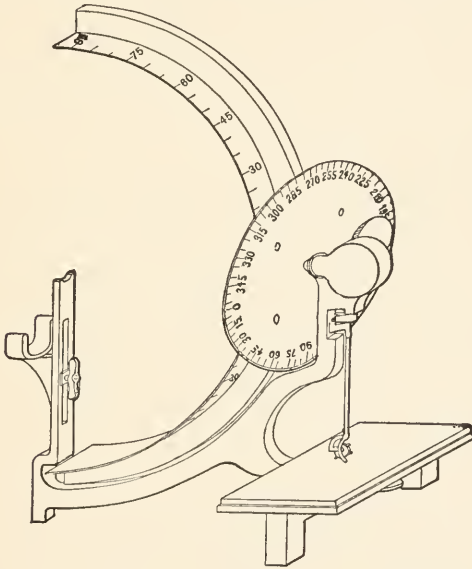

FIG. 9. Perimeter for Mapping the Retinal Zones.

Suppose that the left eye is shaded, and that the right gazes steadily at some fixation-mark placed directly before it, or a little to the right. Suppose, further, that a small red object is moved into the field of vision from the nasal side, so that its image falls upon the temporal half of the right retina. The object first becomes visible as a patch of black ; then it shows as *B* or *Y* ; then, as it advances, it looks *P* or *O* ; finally, as it approaches the fixation-point,



it appears in its true colour, as a carmine or vermilion. Other colours give like results; so that we are finally led to the conclusion that the retina consists of three distinct zones. The outermost zone is totally colour blind, and accordingly furnishes only sensations of light, whatever the stimulus may be. The intermediate zone is partially colour blind and furnishes, besides the sensations of light, only sensations of *B* and *Y*, in all tints and in all degrees of chroma. The middlemost or central area furnishes all the sense-qualities that are represented in the colour pyramid.

We have called the three zones distinct, and it is true that they may be distinguished in any experiment such as that just described. At the same time, as the *P* or *O* phase of the observation shows, they are not sharply separated, but pass gradually into one another. Hence a red object of large area will still be seen as *R* where a smaller object would appear as *P* or *O*, and will still be seen as coloured where a smaller object would look dark grey or black. Similarly, a stimulus of high energy and brief duration will retain its colour farther from the centre than a stimulus of low energy and longer duration. It is, therefore, impossible to map the retinal zones in any hard and fast way. They are regions of relatively, not absolutely different colour sensitivity. Indeed, if the energy of the stimuli were made exceedingly great, it is probable that they would be seen in their true colours over the whole extent of the retina. Under the usual conditions of stimulation, however, the zones are distinct.

A red stimulus, as it travels out from the centre, changes first to *P* or *O*, and then to *B* or *Y*, only because it is not a physiologically pure red. If we can find a red stimulus that has no *B* or *Y* effect, then the red will change to black or grey as soon as it leaves the middlemost zone. This red has, as a matter of fact, been determined; it is not a spectral red or vermilion, but a slightly purplish or carmine red. What holds of it holds also of



its complementary, a spectral hue of about  $495 \mu\mu$ ; this, too, passes directly into grey as it leaves the middlemost zone. If these two colours are equated as regards area, tint and chroma, they become colourless at the same distance from the centre of the retina, so that the zone of red-vision is coextensive with the zone of green-vision. The same thing is true of a  $B$  of about  $470 \mu\mu$  and a  $Y$  of about  $575 \mu\mu$ : the zone of  $B$ -vision is coextensive with that of  $Y$ -vision. The retina thus appears as made up of an outermost  $Bk-W$  zone, an intermediate  $Bk-W + B-Y$ , and an innermost  $Bk-W + B-Y + R-G$  zone.

If a spectrum is thrown upon the  $Bk-W$  zone, it appears, of course, as a band of greys. It is noteworthy that, in light-adaptation, the lightest of these greys occupies the region of the yellow, so that the relative distribution of tint in the colourless spectrum is unchanged. —

Most of us use our eyes for a lifetime, without discovering these differences of zonal sensitivity. The reason is that, in indirect vision, it is very difficult to make out the form, size or contour of objects in the visual field. This sort of discrimination is, however, of great importance for the organism. Hence we habitually turn our eyes toward that which we wish to observe; attention goes with direct vision, and the phenomena of indirect vision are disregarded.

We must say, then, that the normal eye is normal only for purposes of direct vision, while in indirect vision it is partially or totally colour blind. There is also an abnormal colour blindness; certain persons show these defects of vision over the whole extent of the retina. Thus, some 3 per cent. of the male population are, from birth, partially colour blind; their eyes lack the middlemost or  $R-G$  zone. The physiologically pure red and the physiologically pure green, of about  $495 \mu\mu$ , appear to them as grey; the left or long-wave end of the spectrum is yellow, and the right or short-wave end is blue. In other words, the spectrum

looks in direct vision as it normally looks in indirect vision with the *Y-B* zone, or as it normally looks in direct vision when the energy of the light-waves is very great (§ 16); and the whole visual world consists of blacks, whites and greys, together with blues and yellows in all possible variety of tint and chroma.

It follows from this that partially colour blind persons will confuse a pure red and a pure green, if tint and chroma are the same.

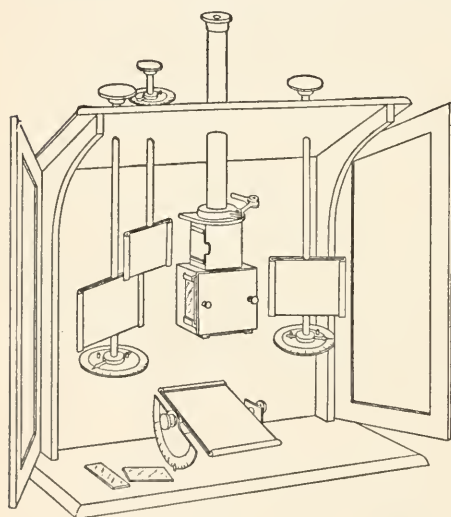

FIG. 10. Hering's Apparatus for the Investigation of Partial Colour Blindness.

They will also, under these conditions, confuse *O* and *YG*, *P* and *BG*, rose and blue, vermilion and brown. In everyday life they make very few mistakes, partly because they have learned the names of coloured objects from their normal-sighted acquaintances, partly because objects of the confusable colours usually differ in tint or chroma or both, as well as in hue, and in certain

cases because difference of hue is connected with a difference of grain or texture.<sup>1</sup>

<sup>1</sup> This, no doubt, explains the otherwise curious fact that only in comparatively recent times has partial colour blindness attracted any widespread attention. Scattered references to it go back to the seventeenth century; but it did not obtain general recognition from scientific men until 1798, when the chemist John Dalton published a paper on Extraordinary Facts relating to the Vision of Colours (*Edinburgh Journal of Science*, ix., 97). Dalton was himself partially colour blind, and for some time the defect was known as Dalton-

There are two types of partial colour blindness. In the first and commoner form, the distribution of tints in the spectrum is the same as in normal vision; the lightest grey lies in the region of yellow. In the second, the lightest grey has shifted towards the short-wave end, and lies in the region of yellow-green. This and certain other anomalies of congenital partial colour blindness still await explanation. — A partial colour blindness due to lack of the intermediate or *B-Y* zone is found only as a pathological condition of the eyes, not as a congenital defect.

A much more serious congenital defect of vision is that known as total colour blindness, in which the eye lacks both the *R-G* and the *B-Y* zones, and the world of colour appears in monotone as an arrangement of blacks, whites and greys. The defect is rare; only some fifty cases have been examined. The totally colour blind eye is nyctalopic; that is to say, its vision, in any state of adaptation, is twilight vision, and the spectrum as seen by it always shows the Purkinje phenomenon. Further, the small central area which, in the normal eye, is permanently hemeralopic is in the totally colour blind eye either wholly or almost wholly blind, so that direct fixation of an object in the field of vision is impossible, and the eye twitches and jerks in the effort after clear vision.

§ 21. **The Primary Colours.** — We have seen that, psychologically regarded, all colours are equally simple; it is impossible, for instance, by introspective analysis to split up orange into yellow and red. On the other hand, certain colours have exceptional positions in the colour pyramid, — those colours, namely, which lie at the four corners of

ism. Latterly the subject has been much discussed, on account of the danger arising from the confusion of red and green signal lights by engineers, pilots, etc.

the base, and which thus begin and end the four colour series. These colours, *R*, *Y*, *G*, *B*, are the psychological primaries.

For technical and artistic purposes, we must give this title to a different set of colours: *R*, *Y* and *B*. The painter who has these pigments upon his palette is able by their means, with the help of white, to reproduce the various colours of nature.

It is a matter of common experience that the mixture of *B* and *Y* paints will give a saturated green. The reason is that the blue pigment crystals reflect *B* and *G* light, the *Y* crystals, *Y* and *G* light. Thus the *B* and *Y* cancel each other, and only the *G* is left to be seen.

For the physicist, again, the primary colours are *R*, *G* and a certain *BV*. The mixture of these three spectral colours, in fitting proportions, will not only give colours of every possible hue, but will also give them at a higher degree of saturation than can be obtained from any other three spectral colours.

Lastly, for the physiologist, the primary colours are the four characteristic colours of the retinal zones: a purplish red, its complementary bluish green of about  $495 \mu\mu$ , and the *Y* and *B* of the intermediate zone. The two latter colours are identical with the psychological primaries. Whether the physiologically pure *R* is identical with the psychological *R* is doubtful; but it is certain that the physiological *G* is not the psychological *G*: it is rather a distinctly bluish *G*.

Evidently, then, the term primary is misleading; what it means depends upon the context in which it is used. We may, perhaps, call the psychological *R*, *G*, *Y*, *B* the principal colours; the artist's *W*, *R*, *Y*, *B* the primary

colours; the physicist's *R*, *G* and *BV* the fundamental colours; and the physiological *C*, *BG*, *Y* and *B* the invariable colours.

§ 22. **Theories of Vision.** — The eye<sup>1</sup> is, in all essentials, a little photographic camera. The eyelids form a cap or shutter, closure of which prevents the access of light. Behind the shutter is an automatic diaphragm, the iris, which closes to a pin-hole or opens out, according to the degree of illumination. Behind the diaphragm is a lens, which may be adjusted for near or far objects. This adjustment is not made by changing the length of the eyeball, as it were by racking the lens back and forth; the soft substance of the lens is encased in an elastic sheath, which is suspended by radial fibres to muscles set vertically in the wall of the eyeball. When the eye is at rest, the anterior surface of the lens is relatively flat, and the organ is consequently adjusted for far vision; if we wish to focus upon a near object, the muscles contract, the pull on the radial fibres is thereby lessened, and the lens assumes a greater curvature. Behind the lens is a dark chamber, lined with a membrane, the choroid, which is deeply pigmented by a colouring matter of dark brown. This chamber, together with the smaller chamber in front of the lens, is filled with a clear semi-fluid or fluid substance, which serves to maintain the shape of the eyeball; and the whole eyeball is surrounded by a leathery protective membrane, the sclerotic, which is pierced behind by the optic nerve and

<sup>1</sup> Models of the brain and sense-organs are manufactured, in all degrees of elaboration, by a number of firms: Auzoux, Benninghoven & Sommer, Bock-Steger, Brendel, Deyrolle, etc. The writer uses, as eye-models, the *Œil complet de très grande dimension*, of the Auzoux series of elastic anatomy, and the models numbered 3 *b* and 3 *l* in the Benninghoven & Sommer series.

passes over in front into the transparent cornea. The retina, or sensitive film, is produced by the expansion of the optic nerve over the posterior two-thirds of the internal surface; it is self-renewing, just as the diaphragm and lens are automatic.

The retina, with which we are chiefly concerned, is a very thin but extremely complex membrane. Its terminal structures, which are the sensitive receivers of the physical light stimulus, are known as rods and cones. In general, these are intermingled over the entire retina. There are, however, two areas—the optic disc and the yellow spot—which show a different formation. The optic disc is the point at which the optic nerve enters the eyeball. Here there is no true retina, but a blind spot, whose situation and dimensions may readily be determined by experiment. The yellow spot or macula lutea lies at the posterior pole of the eyeball: it is peculiarly sensitive to form and contour, and is therefore termed also the spot of clearest vision. At the centre, in the fovea centralis, it shows a depression, where the retina consists of little more than a single layer of attenuated cones. The whole spot is coloured yellow, so that in macular vision the colours of the short-wave end of the spectrum are somewhat darkened. —

It is not possible, in the present state of our physiological knowledge, to give an entirely satisfactory explanation of all the facts of visual sensation. The following, however, seem to be the most reasonable hypotheses.

(1) *The Theory of Dual Vision.* — Many indications point to the conclusion that the rods are the end-organs of twilight, the cones the end-organs of daylight vision. That is to say, the rods are organs which, under stimulation



by light-waves whose energy is too low to stimulate the cones, furnish us with sensations of light. The blindness of the normal fovea at night-time is due to the fact that the retina is there composed only of cones. The Purkinje phenomenon, and the exceptions to the third law of colour mixture, are to be ascribed to the rods: they mean that the rods are affected by light-waves of different length otherwise than are the cones. The typical retina of the totally colour blind eye is a rod-retina, lacking functional cones, and the complete blindness of the fovea is a necessary result.

We have seen that twilight vision is extremely dependent upon dark-adaptation. It is significant, in this connection, that the terminal members of the rods contain a purplish red substance, the visual purple, which bleaches on exposure to light and is reformed under the influence of darkness. It is further significant that the distribution of tints in the Purkinje spectrum (lightest region in *G*) accords with the chemical action of the different light-waves upon the visual purple. Whether, however, the visual purple is essentially concerned in rod-vision, or whether it serves merely to sensitise the visual apparatus, cannot certainly be decided. The retinas of nocturnal animals — owls, bats, rats, moles — are almost wholly deficient in cones, while their rods are richly supplied with the visual purple. Animals whose eyes lack this rod-pigment — fowls, pigeons — are strictly diurnal in their habits.

(2) *The Phenomena of Daylight Vision.* — There are two current theories of daylight vision, called respectively the Helmholtz and the Hering theory. Both are adequate to a large proportion of the facts; both have been variously modified to accord with newly discovered facts; neither fits the facts in complete detail. Both, of course, are physiological theories; but Helmholtz approaches physiology by way of physics, Hering rather by way of psychology. The

following account agrees, in its main outlines, with Hering's view.

We assume that the retinal cones contain three visual substances, which are decomposable by light, and which are the vehicles of reversible or antagonistic chemical reactions. We may term them the black-white, the blue-yellow, and the red-green substances. The cones of the central area contain all three; those of the intermediate zone mostly contain the *Bk-W* and the *B-Y* substances; and those of the outermost zone mostly contain only the *Bk-W* substance. The latter, which is thus the most widely distributed of the visual substances, is affected by every light stimulus which exceeds a certain lower limit of energy; the other two are affected only by the wave-lengths corresponding to their names. The six chemical reactions which occur in the three substances give rise to the sensations of black, white, and the four invariable colours. From them and their combinations are derived, with a single exception, all the phenomena of daylight vision.

The exception is the sensation of neutral grey. Since this sensation may persist while the retinal organs are out of function, it must take its origin in the brain. We ascribe it to the molecular motion of heat in the cells of the visual cortex, and are thus able to explain both its constancy and its qualitative character.

According to this view, the retinal processes which arouse the sensations of *Bk* and *W*, *B* and *Y*, and invariable *R* and *G* are antagonistic and incompatible. If, for instance, by mixing a dark *B* and a light *Y* on the colour mixer, we expose a certain area of the intermediate zone to light which affects the *Bk-W* and the *B-Y* substances in equal and opposite ways, no retinal sensation will be set up by the stimulus; we ought, so to speak, to see



nothing whatever. What we do see is a middle grey, the grey which is to be referred to the cortex. This grey, which mixes with all retinal sensations, is constant, because the heat-energy of the cortex is constant; it is grey because, unlike the sensations of light from the retina, it derives simultaneously from both of the antagonistic *Bk-W* reactions:—such a simultaneous occurrence of opposed processes is, as physics tells us, precisely the effect produced by heat within a body which is in chemical equilibrium. The office of the cortical grey is to prevent the darker objects in the field of vision from being drowned out by their lighter surroundings.

The facts of indirect vision are explained by the distribution of the visual substances over the retina. The *Bk-W* is, evidently, the oldest, the *R-G* the youngest, of the three. Hence the *R-G* is also the most instable. In cases of partial colour blindness, it does not occur at all, while the *Bk-W* and the *B-Y* substances are intact. If the light-waves possess a very high degree of energy, it is thrown out of function (§ 16).

The facts of colour mixture may easily be worked out in terms of the three retinal substances and the cortical grey. Take, for instance, the fact that *C* and *BG*, mixed in the right proportions, give grey. The stimuli affect the *R-G* substance in equal and opposite ways. They also affect the *Bk-W* substance: perhaps equally and oppositely, perhaps both by way of *Bk* or both by way of *W*, perhaps differently, so that the one of these antagonistic processes is stronger than the other. In the first case we see simply the cortical grey; in the second, a distinctly dark or a distinctly light grey; in the third, a slightly dark or somewhat light grey, according as the retinal excess has fallen on the side of *Bk* or of *W*. The same sort of analysis may be carried through for the mixture of other light stimuli, in any number and of any wave-length.

To account for contrast, we have merely to suppose that the retinal substances tend towards equilibrium over the whole area of their distribution, so that, directly affected at one point, they are indirectly—and oppositely—affected at all other points, though most noticeably, of course, in the immediate neighbour-

hood of the stimulus. If we look at a red square on a grey ground, we see at once the contrast-fringe of verdigris; it is as if the whole of the *R-G* substance were up in arms to repel the invasion. The same thing holds of other stimuli, including *Bk* and *W*; all alike call out, indirectly, the antagonistic retinal process.

Lastly, the phenomena of adaptation and after-image follow from the antagonistic character of the reactions in the three substances. As we gaze at the red square, the *R*-reaction of the *R-G* substance is gradually reduced; or, what is the same thing, the *G*-reaction is gradually strengthened. Presently, the two reactions are of equal strength; adaptation to the coloured stimulus is complete, and we see grey. If, now, the red square is removed, the *G*-reaction is suddenly given the ascendancy, and shows itself in the complementary colour of the after-image.

#### References for Further Reading

§§ 14-22. The dual theory of vision was first propounded by the histologist M. J. S. Schulze in 1866 (*Zur Anatomie und Physiologie der Retina*, in *Archiv für mikroskopische Anatomie*, ii., esp. 255 f.). Its establishment in recent years has been largely due to the work of J. von Kries, professor of physiology in the University of Freiburg i. Br., who has described it in the chapters entitled *Die Gesichtsempfindungen*, in W. Nagel's *Handbuch der Physiologie des Menschen*, iii., 1905, 109 ff. Here will also be found a full statement and criticism of the Helmholtz and Hering theories. For the Helmholtz theory, and its debt to Thomas Young, see H. L. F. von Helmholtz, *Handbuch der physiologischen Optik*, 1896, esp. §§ 20, 23. The theory of E. Hering, who is now professor of physiology in the University of Leipzig, is set forth in *Zur Lehre vom Lichtsinne*, 1874, and *Grundzüge der Lehre vom Lichtsinn*, pts. i., ii., 1905, 1907 (not yet completed). The cortical origin of the sensation of grey was suggested by G. E. Müller, professor of philosophy at Göttingen, in *Zur Psychophysik der Gesichtsempfindungen* (offprinted from *Zeitschrift für Psychologie und Physiologie der Sinnesorgane*), 1897.—Consult also W. H. R. Rivers, *Vision*, in *E. A. Schäfer's Text-Book of Physiology*, ii., 1900, 1026; art. *Vision*, in *J. M. Baldwin's Dictionary of Philosophy and Psychology*, ii., 1902, 765 ff.; I. M. Bentley, *The Simplicity of Colour Tones*, *American Journal of Psychology*, xiv., 1903, 92; J. W. Baird, *The Colour Sensitivity of the Peripheral Retina*, 1905.

## AUDITION

§ 23. **The Auditory Qualities.**—The world of sound, like the world of sight, is made up of two classes of sensations, the one variegated and of manifold quality, the other sober and monotonous. These are distinguished, in ordinary speech, as tones and noises. Tones, which correspond to the sensations of colour, are the proper material of music; they have a certain clarity and stability which fit them for their place in art. Noises, which correspond to the sensations of light, are dull and instable; if momentary, they are abrupt and harsh, if continued, they are rough and turbid. And as in vision, so in audition, the two kinds of sensation are in some measure independent, while at the same time they are intimately related.

We are apt to think of tones as coming from a musical instrument, piano or violin. Musical tones are, however, complicated mixtures of tones and noises (§ 25).

To obtain sensibly pure tones, elementary tonal processes, we must have recourse to special apparatus: the best are weakly sounding tuning-forks standing on their resonance boxes, and weakly blown bottles. If we

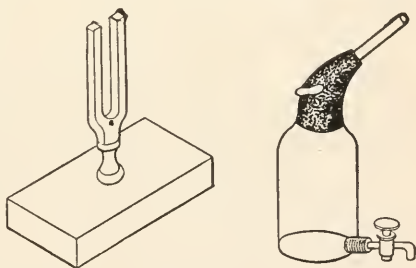

FIG. 11. Tuning-fork on Resonance Box, and Glass Bottle, fitted with mouthpiece for blowing. The pitch of the bottle-tone may be raised or lowered by pouring in or letting out water.

work through a long series of such pure tones, we notice, first, that they differ qualitatively as high and low; they show differences of pitch. These terms are, of course, spatial in origin, and it is not altogether easy to see how they came to be applied to tonal qualities.<sup>1</sup> At any rate, they are in current use, and we understand their meaning. We notice, secondly, that the tones differ qualitatively in what we must call—again in spatial terms—size or diffusion. This attribute runs, in general, parallel with the attribute of

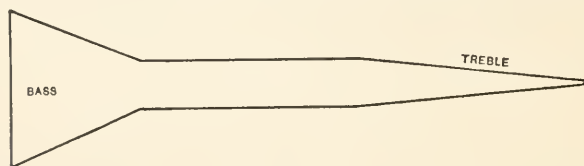

FIG. 12. The Tonal Pencil, representing the sum-total of tonal qualities, as the Colour Pyramid represents the sum-total of visual qualities. The horizontal dimension corresponds to the attribute of pitch, the vertical to the attribute of volume.

pitch; but at the ends of the scale it changes more quickly, in the middle region more slowly, than pitch, so that deep tones appear very large and diffuse, and high tones very small and concentrated, while the intermediate tones seem all to be more or less of the same size.

As we have already said (§ 11), some psychologists believe that tones have a truly spatial attribute of volume, while others think that the low tones merely remind the hearer of large things and the high tones of small. This second view contains, undoubtedly, a good deal of truth. The deepest tones from the organ, for instance, are not only heard, but are also felt as a thrill over the

<sup>1</sup> The composer Berlioz remarked that, on the piano, high means right and low means left in the horizontal plane; and that, if the violinist's hand rises, for high tones, the cellist's drops. The whole question is discussed by C. Stumpf, *Tonpsychologie*, i., 1883, § 11.

whole body; and the size of musical instruments varies with the height of their tones. Children call deep and high tones big and little, old and young: evidently because the former come from the large grown-up people, and the latter from their small play-mates. At the same time there can be no doubt that what we have termed diffusion and concentration is an inherent attribute of tones; only, we need no more regard it as really spatial than the other attribute of height or pitch. In trying to specify the ultimate characters of sensation, we have to take language as we find it, and to use metaphor and analogy. We speak of colour-tone and of colour-depth, but we do not mean that the hues sound differently, or that we can drop a stone into them. So we shall speak presently of tone-colour, without implying that tones are red or green. Pitch and size stand for certain qualitative aspects of tonal sensation, and neither can be understood literally in terms of space. —

There seems, in the musical scale, to be a periodical recurrence of tonal quality; the corresponding notes of successive octaves, if struck together, sound in unison. It has therefore been suggested that the tonal system must be represented, not by a straight line, but by a line which returns upon itself, a spiral line. This resemblance of a note to its octave is not, however, a matter of pure sensation; it depends upon conditions which we discuss in Pt. II. If the finger is run in a glissando over the white keys of the piano, the impression obtained is that of a linear series of tonal qualities. Hence our sensations of tone may be represented by a straight line which tapers, in three divisions, from bass to treble, being broadest for the diffuse deep tones and narrowest for the small and concentrated high tones.

The noises that we hear in everyday life are of two kinds, explosive and continuative. For the former, we have such words as crack, pop, snap; for the latter, such words as hiss, sputter, rumble. It seems, at first thought, that the continuative noises might very well be regarded as repeated explosions; a rattle or clatter, for instance, is

*Our whole thinking in large  
in geometric terms.*

simply a quick succession of raps or shocks. This reduction cannot, however, be carried through. Such noises as the hiss of escaping steam, the souging of wind in the trees, the rustle of a newspaper,—complex as they certainly are,—refuse to be analysed by introspection into series of explosions; and in the pattering of rain, or the sizzle of frying fat, we distinguish the rapidly recurring taps or clicks from the steady hiss of the background. There are, then, two types of noise sensation, the snap and the hiss, to be set alongside of the sensations of tone.

There can be no question that sensations of tone may be had without accompanying noise. It is much more difficult to decide whether sensations of noise occur without accompanying tones. In the first place, all explosive noises have a certain, more or less definite pitch. A hand-clap sounds lower than a snap of the fingers, the crack of a rifle lower than the spit of a revolver. This statement holds of the simplest noises that we can produce in the laboratory. Thus, if soap-bubbles are filled with a mixture of air and hydrogen, and touched off with a match, the large bubbles give a deeper pop than the small. Or if tuning-fork tones are cut down to mere momentary puffs of sound, we hear short, dry strokes which are deeper for the large forks than for the small. It would seem that, in such cases, we are listening to simple, toneless noises,—in which event we must say that these noises show differences of pitch akin to the pitch-differences of tones, though of a coarser kind. But there is an alternative. If a bar of wood is dropped upon a wooden table, we hear a thud which sounds merely noisy. If, however, we drop a series of bars, cut to the right lengths, we hear, over and above the noise, a series of definite tones, an air played in a certain key. The single thud contains a true tone, but a tone of such short duration that introspection fails at first to find it. And the same thing may be true of the noises from the soap-bubbles and the tuning-forks. If, again, we pass the finger-nail slowly over the ribbed binding of a



book, we hear a succession of plucks or taps; but, if we move more quickly, a distinctly tonal scroop. The pitch of the separate taps may, then, itself have been tonal.

In the second place, it seems safe to say that no continuative noises are known which do not contain recognisably tonal elements. The buzz of voices in a crowded room, the beat of waves upon a beach, the scrape of a book against others as it is returned to the shelf, the whisper of an *S*, the drag of matting over a floor, all alike contain various tones which can be singled out by the trained ear.<sup>1</sup> And, contrariwise, a continuative noise may be generated from a medley of tonal stimuli. If you press down, all together, an octave of notes in the bass of a piano, — better still, if you press suddenly upon the loud pedal, without striking the keyboard, — you hear a harsh, booming or rumbling noise with but little trace of tone.

In fine, introspection distinguishes between tones and noises; and, among noises, distinguishes such things as hiss, murmur, sigh, purl, crash, rumble from such things as snap, puff, knock, clack, roar. But we have, as yet, no means of determining with accuracy the nature and number of the elementary noise qualities.

§ 24. **The Dependence of Auditory Sensation upon Wave-number of Sound.** — Sound-waves, like light-waves, differ in respect of wave-length, wave-amplitude or energy, and wave-form or composition. We are not here concerned with their energy, since this has no influence upon the quality of auditory sensation. And we shall speak, not of wave-length, but rather of the wave-number — the number of complete waves in the 1 sec. — which is definitely correlated with it. As referred to the tones themselves, this is usually termed pitch-number; as referred

<sup>1</sup> Stumpf narrates that, in listening to a mountain brook, he heard a clear and steady tone of  $f^{1\frac{1}{2}}$ , with neighbouring tones playing about it; further, a clucking and gurgling, made up of momentary deeper tones; and behind all the noisy splash which could not be analysed. *Tonpsychologie*, ii., 1890, 502.





FIG. 13. The Series of Auditory Qualities. The keyboard of a grand piano extends from the  $A_2$  of 27.5 vs. to the  $c^8$  of 4224 vs. The smaller piano keyboard ranges between the  $C_1$  of 33 vs. and the  $a^4$  of 3520 vs.

Helmholtz' lower limit of orchestral music is the  $E_1$  of 41.25 vs. (double bass); his higher limit, the  $a^5$  of 4752 vs. (piccolo flute). The organ has a range of 9 octaves:  $C_2$  (16.5 vs.) to  $c^6$  (8448 vs.). The highest note of the violin is the  $e^4$  (2640 vs.). The range of audition is, approximately, from the  $G_2$  of 12.35 vs. to the  $f^8$  of 45056 vs.

to the motion of sonorous bodies, it is termed vibration-rate.

Wave-number determines the quality, the pitch and size, of tonal sensations. The tones of the musical scale range between the limits of about 40 and 4000 vs. in the 1 sec. The range of audible tones is much wider, from about 12 to about 50000 vs. Between these extremes the trained ear can distinguish some 11000 different tones.

Wave-number also influences the intensity of tonal sensations. High tones are intrinsically loud, and low tones intrinsically weak, — very much as, in the spectrum,  $Y$  is a light and  $V$  a dark colour.

The three attributes of pitch, size and intensity, in so far as intensity is dependent not on energy but on pitch-number, constitute together what is known as tone-colour. High tones have a lighter or brighter, low tones a darker or duller colouring. Where we are dealing with relatively simple tones, the introspective analysis of tone-colour is not very difficult. The single term becomes useful, however, when we are considering the compound tones employed in music.

Over the greater part of the musical scale — from the lowest tones to tones of about 3000 vs. — two complete sound-waves suffice to arouse a tonal sensation, while stimuli of less than two

waves give rise to a snap or stroke. Physically, then, this explosive noise is merely an incomplete tone. The probable character of noise stimuli in general is discussed in the following § 25.—

The lower limit of tonal hearing may be determined by means of tuning-forks or of a steel lamella. Giant tuning-forks have been constructed, which vibrate very slowly; the rate of vibration may be varied by the adjustment of sliding weights upon the tines. The weighted wire forks, a specimen of which is shown in Fig. 14, are more manageable. The lamella is a blade of soft steel, clamped in a wooden vise, and actuated by the finger; a scale engraved on the blade indicates the rate of vibration.

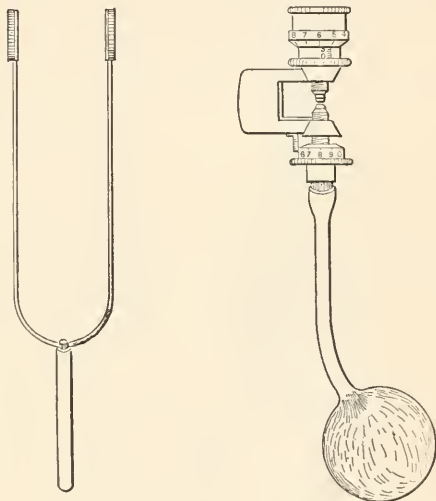

FIG. 14. Weighted Wire Fork and Galton Whistle.

The upper limit may be determined by means

of very small tuning-forks, actuated by a bow, or more easily by means of the Galton whistle shown in Fig. 14. The whistle is a very small stopped labial pipe, actuated by the squeeze of a rubber bulb, and closed by a piston which is adjustable by a micrometer screw.

The series of distinguishable auditory qualities, between the upper and lower limits, may be worked out in part by means of a set of weighted wire forks and of a Galton whistle. For the middle region of the scale we may use a tonometer: a series of delicately adjusted tuning-forks, or a series of metal tongues of minimally different lengths thrown into vibration by a bellows. A less expensive apparatus is the Stern variator shown in Fig. 15. This consists essentially of a blown brass bottle, whose pitch may

be varied, little by little, through the introduction or withdrawal of a piston.

§ 25. **The Dependence of Auditory Sensation upon Composition of Sound.**—The train of sound-waves which

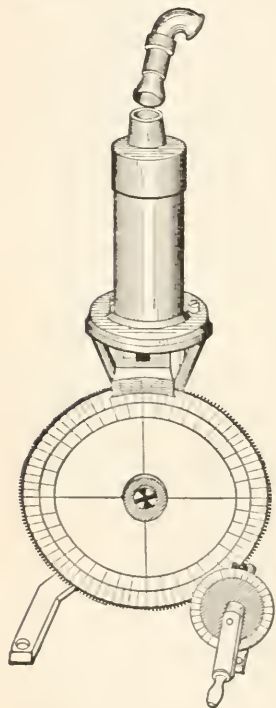

FIG. 15. Stern's Variator.

arouses a sensation of tone is a periodic vibration of simple harmonic form; the motion of the air-particles is a simple pendular motion. Periodic vibrations of any other form may be analysed, mathematically, into a series of superposed simple harmonic vibrations, whose wave-numbers are multiples of the wave-number of the given vibration. That is to say, the complex wave may be regarded as made up of a group of simple waves, whose wave-numbers— if the wave-number of the complex wave is taken as 1—stand in the ratios 1:2:3:4, etc. All musical tones or, as we may call them, compound tones are aroused by trains of waves of this complex kind.

The ear, unlike the eye, is an analysing organ; and it is therefore possible, within limits and after practice, to single out the simple tones which together constitute the compound tone,—to repeat in sensation the analysis already performed by mathematics. The compound tone then splits up into partial tones, the lowest of which is

termed the fundamental, and the rest the upper partials. Sometimes the upper partials are distinguished as the overtones of the fundamental: this usage is a little confusing, since the second partial becomes the first overtone, and so on. The partial tones, when thus singled out by the attention, have the simple character of the tones produced by tuning-forks or blown bottles; they sound, that is, as pure tones, and do not differ with the different instruments from which they come.

Most of us, however, lack the training, and some lack the ability, to resolve a compound tone into its simple components. Under these circumstances, the tone is itself heard as simple, but has upon it a certain colouring or timbre, which varies with the various instruments. The tone of the organ is full and rich, that of the trumpet is hard and rasping, that of the clarinet is hollow and nasal. These differences of timbre are primarily due to the differences in the number and relative intensity of the overtones which accompany the fundamental.

A musical instrument consists essentially of a vibrating body — plate, rod, string — and a resonance chamber; a tuning-fork on its resonance box offers a simple illustration. The complexity of the air-waves which it sends to the ear may be variously produced. The vibrating body may, like the piano string, be so constituted as to vibrate in halves, thirds, quarters, etc., at the same time that it vibrates as a whole. Or it may be forced into complex movements by the manner in which it is actuated; thus the violin string vibrates as a whole, but also zigzags back and forth as it is drawn forward by the bow and slips away again. Or, lastly, it may vibrate as a simple pendulum, and yet not impart a pendular movement to the air-particles; the metal tongue, for instance, vibrating in an opening which it almost fills, gives rise to extremely complicated motions of the surrounding air. When

all these possibilities are taken into account, it is not surprising that even relatively pure tones should be of rare occurrence.

The timbre of the compound tone is, in the main, the unanalysed resultant of the tone-colours of its simple constituents. Bearing in mind the nature of these tone-colours, we have no difficulty in explaining the timbre of most musical instruments.

A piano tone, for instance, necessarily sounds brighter—and therefore, to the untrained ear, higher—than a flute tone of the same pitch, because it contains a longer series of overtones. These are, of course, progressively higher than the fundamental; and high tones have a bright tone-colour. The full and rich tones of open organ-pipes, piano and French horn are due to the presence, at moderate intensity, of the first half-dozen partials. The harsh and penetrating tones of trumpet, bassoon, harmonium are due to the predominance of the higher overtones. The tone of the clarinet contains only the odd-numbered partials. Its nasal character must probably be ascribed to the presence of beats (§ 26) and to the fact that the difference-tones (§ 27) produced by the partials do not coincide with the constituent simple tones.

If we extend the meaning of timbre to cover everything that helps us to distinguish the tones of the different musical instruments, we must further mention, in the first place, the different noises that accompany them. The scrape of the violin, the pluck of the banjo, the thud of the piano, the sish of the wind instruments, are characteristic. So also is the manner in which the tones enter consciousness; the large brass instruments lumber into hearing, the flute glides in. Other criteria are pitch, intensity, variability, and mode of performance. An instrument that moves in the  $c^5$ -octave can hardly be anything else than a piccolo; an instrument that sounds at a certain loudness must be a trumpet. The oboe is distinguished by a peculiar delicacy of dynamic shading. Lastly, many instruments have peculiar features of melody or harmony, rhythm or modulation, so that they may be identified by the nature of their performance. We can hardly think of flute, harp, trumpet, without at the same time thinking

of the special way in which they are played, or the special use to which they are put in orchestral music. —

It is sometimes said that tonal stimuli are periodic, noise stimuli aperiodic movements of the air-particles. But, on the one hand, aperiodic vibrations may produce tonal sensations, as in the 'rising tone' of the siren; and, on the other, a periodic vibration of short duration or a mixed medley of periodic vibrations may, as we have seen, produce noise. The air-shock ordinarily caused by an explosion is probably a periodic system of many, slightly different wave-numbers and of rapidly decreasing intensity; so that, from the physical point of view, the crack or roar is a mixture of incomplete compound tones. In the same way, the continuative noise is probably due to a very large number of vibrations, differing relatively little in periodicity but widely in duration. Physically, that is, the hiss must be regarded as a mixture of compound tones, both complete and incomplete. This physical likeness of noise and tone stimuli, which enables them to act upon the same sense organ in much the same way, accounts for the introspective difficulty of distinguishing the tonal and the noisy elements in many instances of auditory sensation.

§ 26. **Beats and Intermediate Tones.** — Tones are intrinsically harmonious, as colours are intrinsically antagonistic. It is this character of tonal sensations which, as we shall see later, has determined the choice of notes in the musical scale and the development of music as melody and harmony. In the meantime, we must take account of two sensory phenomena which result from the blending of tones: the production of beats and intermediate tones, and the production of what are called combinational tones. —

If two tones of precisely the same pitch-number are heard at the same time, the resulting sensation differs from its constituents merely in the attribute of intensity. When the trains of air-waves are so timed that crest coin-



cides with crest and valley with valley, it is stronger than the single tone; when the crests of the one train overlap the valleys of the other, it is weaker.

If, now, the one of the two simultaneously sounding tones is mistuned, so that its pitch-number is somewhat raised or lowered, the resulting tone is no longer smooth and continuous, but shows rhythmical fluctuations of intensity, which are known as beats. So long as the mistuning is slight, the beats are slow; the tone surges up to its maximal intensity and gradually subsides again. With increasing difference of the generating tones, the beats become quicker and quicker. At the same time they grow harder and less billowy, so that they may be compared to the rattle of a kettle-drum, or even to a rapid succession of hammer-strokes upon an anvil. As the pitch-numbers diverge still further, the separate beats give place to an unanalysable roughness, harshness or hoarseness, which with yet wider separation of the generators finally disappears.

The number of beats produced in the 1 sec. is always equal to the difference between the pitch-numbers of the generating tones. For suppose that we are listening to tones of 100 and 101 vs., and that the two trains of air-waves start in the same phase. At the end of the first half-second, the tone of 101 vs. will be exactly half a vibration in advance of the tone of 100 vs.: crest will coincide with valley, and the resulting tone will be weakened. At the end of the second half-second, the tone of 101 vs. will be exactly one complete vibration in advance of the other: crest will coincide with crest, and the resulting tone will be strengthened. We hear, therefore, one beat, one intensive fluctuation, in the 1 sec.; and  $101 - 100 = 1$ . The same rule will evidently hold for any other pair of generating tones.

Beats are easily distinguished and counted when they occur at



the rate of 3 or 4 in the 1 sec. They may be followed, by a practised ear, from a lower limit of 1 in 180 sec. to an upper limit of some 20 or 30 in the 1 sec. At this point, however, the complex is already becoming rough. The impression of roughness or harshness is more pronounced and more persistent in the high than in the low regions of the tonal scale. Thus, the tones *CG*, *Gc*, *ce*, *eg*, *c<sup>1</sup>d<sup>1</sup>*, *d<sup>1</sup>e<sup>1</sup>*, *b<sup>1</sup>c<sup>2</sup>* produce, all alike, 33 beats in the 1 sec.; but the roughness is increasingly marked as the pitch-numbers grow larger. Similarly, the transition from harshness to smoothness occurs in the great octave at about 40, in the four-accented octave only at about 400 beats in the 1 sec.

The surging beats which proceed from a very slight difference of pitch-number are heard as fluctuations of a single tone, whose pitch is indistinguishable from that of the generators. As the difference increases, the single beating tone may be recognised as an intermediate tone, which at first lies near the lower generator, and gradually rises in pitch until it approaches the upper. With a certain amount of difference (in the once-accented octave, a difference of the musical interval of the major second), the two generating tones may be heard alongside of the intermediate tone. The upper generator now appears, with occasional intermissions, as a smooth and continuous tone: the intermediate tone, which carries the beats, begins to take on a noisy character: the lower generator, whose identity is somewhat obscured by the presence of difference-tones (§ 27), is less stable than the upper, but seems in general to have little or no share in the production of the beats. Finally, after this stage has been passed, the intermediate beating tone loses its tonality, and we hear the two generators as separate tones, accompanied by a continuative noise,—the harshness or roughness mentioned above.

The gross phenomena of beats may readily be demonstrated by means of tuning-forks, blown bottles, etc. To distinguish the generators above and below the beating intermediate tone is, however, by no means easy, and requires special practice. This intermediate tone, it may be remarked, is of physical origin; under certain conditions, the superposition of two pendular vibrations of nearly the same wave-number gives rise to a resultant vibration of intermediate wave-number.<sup>1</sup>

If compound tones are sounded together, beats may arise between their overtones. Under certain circumstances, the overtones of a single compound tone may also beat with one another. Thus, in the case of the *C* of the harmonium, the partial tones from the seventh ( $b^1$ ) onwards are sufficiently near and sufficiently strong to produce sensible beats.

§ 27. **Combinational Tones.** — If we sound together two precisely similar tones from the upper region of the tonal scale, and slowly mistune the one without changing the other, we shall hear, according to the statements of the previous section, first a single smooth tone, then a surging, and presently a hammering tone. When the beats have reached a frequency of some 30 in the 1 sec., we hear an entirely new, very deep tone, whose pitch-number corresponds to the difference between the pitch-numbers of the two generators. If we term the upper generating tone  $u$ , and the lower  $l$ , we hear, in general, a third tone whose pitch-number is  $u - l$ . This is known as the first difference tone,  $D_1$ . Under favourable circumstances, a single pair of tones will give rise to no less than five difference tones, whose pitch-numbers correspond to the successive differences between the pitch-numbers of the lowest tones present in the complex. Thus, let  $u$  be a tone of 1328 and  $l$  a tone of 1024 vs. ( $c^3$ ). Then we have

<sup>1</sup> Rayleigh, *The Theory of Sound*, i., 1894, 49, 71; ii., 1896, 443, 450.

$$\begin{aligned}
 D_1 &= u - l = 304 \\
 D_2 &= l - D_1 = 2l - u = 720 \\
 D_3 &= D_2 - D_1 = 3l - 2u = 416 \\
 D_4 &= D_3 - D_1 = 4l - 3u = 112 \\
 D_5 &= D_1 - D_4 = 4u - 5l = 192
 \end{aligned}$$

all of which may be rendered audible to the practised ear.

Difference tones may be demonstrated by means of high forks, Galton whistles, Quincke tubes, a double bicycle whistle, etc. To hear them, one must neglect the high tones of the instruments, and listen for something lower and larger. Sometimes the difference tone seems to be diffused through the room, like the humming of a top;

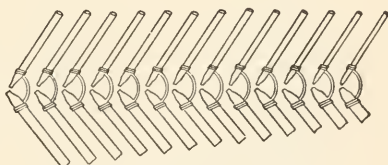

FIG. 16. Set of Quincke Tubes.

sometimes it seems to be a deep booming within the ear. A very striking demonstration may be given with two Galton whistles, the one of stationary and the other of varying pitch. Since a difference of a certain number of vs. means a much wider interval in the region of the difference tone than in that of the generators, a slight change of the whistle will produce a pronounced change in the difference tone, which accordingly sounds as the howling of the wind, or as the tone of a fog-siren.—To hear the whole series of difference tones requires special training.

The difference tone, unlike the intermediate tone of the preceding section, cannot be obtained by the superposition of pendular vibrations. It must, therefore, if it exists outside the ear at all, be set up by some secondary vibration of the sonorous body. Objective difference tones are, as a matter of fact, generated by instruments, like the harmonium, in which the two primary tones are produced by the same air-blast, and by certain forms of vibrating membranes. The great majority of difference tones are, however, subjective,—ear tones and not air tones. They are occasioned by the mechanism of the ear itself.

It is noteworthy that difference tones behave, in tonal complexes, precisely as their generators. A difference tone, that is, may beat

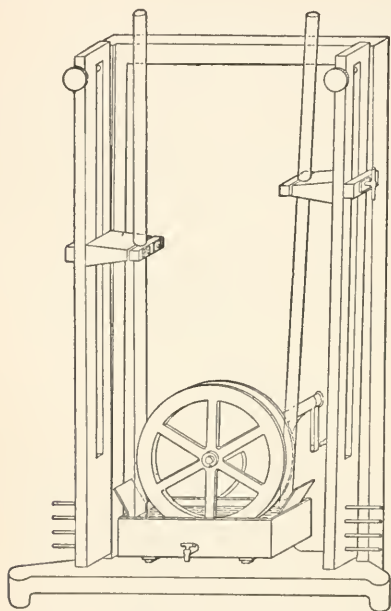

FIG. 17. R. Koenig's Apparatus for the Demonstration of Difference Tones.—*Quelques Expériences d'Acoustique*, 1882, 165.

with another difference tone or with a generating tone; and two difference tones, or a difference tone and a generating tone, may give rise to an intermediate tone and to new difference tones. So far as hearing is concerned, the difference tones are on an equality with the tones aroused by air-waves.

Difference tones have been known to science since the middle of the eighteenth century. In 1856, Helmholtz announced the discovery of another kind of combinational tone, which he named the summation tone; its pitch-number is  $u+l$ , the sum of the pitch-numbers of the two generators. The summation tone is faint, and difficult to distinguish; indeed, many investigators have questioned its existence. Recent observations seem, however, to leave little doubt that Helmholtz' statement is correct.

It has been suggested, in particular, that the summation tone is simply a difference tone of a higher order, generated by the first overtone of  $u$  and the first difference tone; for  $2u - D_1 = 2u - (u-l) = u+l$ . As, however, an objective summation tone is

produced and produced only by those instruments which produce objective difference tones, it is clear that the physical conditions for the arousal of the two kinds of combinational tones are the same. And as the ear has shown itself able to originate difference tones, we may naturally suppose that it can also originate the summation tone. Moreover, the presence of the summation tone has been recorded under circumstances which seem to preclude the possibility of its generation by an overtone. Owing to its faintness, it is much less important, psychologically, than are the difference tones.

§ 28. **Theory of Audition.**—Sound-waves are received into the outer ear-passage, and impinge upon the tympanic membrane or drum-skin, which forms the boundary between the external and the middle ear.<sup>1</sup> The vibrations of this membrane are transmitted by the auditory ossicles, with diminished amplitude of excursion but increased energy, to the oval window. Here they are transferred to the lymph with which the internal ear is filled.

The cochlea of the internal ear, with which, as the end-organ of hearing, we are here concerned, is a structure of great complexity. If we unroll it, we have a long inelastic tube, filled with water; both ends are closed, but the one end contains two windows, filled with elastic membranes,—the oval window above and the round window below. Between the windows lies a horizontal shelf or partition, which divides the tube into an upper and a lower half, and

<sup>1</sup> The author uses, as ear-models, the Auzoux *Oreille de très grande dimension*; the model numbered 4 b in the Benninghoven & Sommer series; a pair of very large models of the internal ear, from the Bock-Steger series (these seem not to have been advertised of late years, but are probably still procurable; they are excellent for purposes of demonstration); and Helmholtz' model of the middle ear. Natural preparations of the temporal bone, and casts of these preparations (with enlarged models of the ossicles), may also be obtained. The Ludwig or Merk model of the organ of Corti is useful for a detailed demonstration.

which extends throughout almost its whole length. The partition, which we may conceive of as a long narrow rectangle, consists partly of bone and partly of membrane. The bone is widest at the windows and narrowest at the far end of the cochlea; the membrane forms a triangle with its apex at the windows. This triangular membrane, known as the basilar membrane, carries the hair-cells with which the fibres of the auditory nerve are connected, and which thus correspond to the rods and cones of the retina. Finally, the upper half of the tube is subdivided by a membranous cross-partition, stretched obliquely between the oval window and the hair-cells, as if to protect these from the direct impact of the waves set up by the push of the ossicles.

We have seen that the ear is an analyser, that it is able to split up a compound wave-motion into simple pendular vibrations, or to resolve a compound tone into simple partial tones. According to the theory of Helmholtz, this analysis is performed by the basilar membrane. Histologists tell us that the membrane is composed, in essentials, of a large number of cross-fibres — variously estimated at 13400 to 24000 — which range in length from 0.041 to 0.49 mm., a ratio of 1 : 12. The fibres represent a system of stretched strings, like those of a harp or a piano, and will accordingly respond by vibration to the wave-movements to which they are tuned. Suppose, then, that a wave-motion of a certain frequency is set up at the oval window. The motion is transmitted, through the membranous cross-partition, to the basilar membrane. A certain basilar fibre (the fibre whose natural period of vibration is the same as that of the incoming wave) is set vibrating; this vibratory movement is imparted to the hairs of the cells which rest

upon the fibre; and the agitation of the hairs acts as stimulus to the fibrils of the auditory nerve. The wave-motion, having thus done its work upon the basilar membrane, spends itself at the round window, and the whole system comes to rest again.

The Helmholtz theory regards the fibres of the basilar membrane as resonators, and is therefore known as the resonance theory of audition. Just as the strings of a piano respond selectively when a tone is sung into the instrument, so do the basilar fibres vibrate in sympathy with the wave-motion which corresponds to their natural period of vibration. The tuning of the fibres and their selective response to stimulus must not, however, be thought of as absolute. Neighbouring basilar fibres differ but little in length, and are closely bound together. Hence we must suppose that, if a simple pendular vibration is set up at the oval window, it is not a single fibre but rather a narrow strip of the basilar membrane which falls into sympathetic vibration. The sensation of simple tone results from the agitation of the hairs of a little group or field of hair cells.

To account for the sensation of noise, we need only assume that a broader strip, or perhaps that several broad strips of the basilar membrane at the same time are thrown into brief vibration. The compound tone will be produced by the simultaneous vibration, at different amplitudes, of a number of narrow strips, each one of which, if it vibrated alone, would give us the sensation of a simple tone.

To account for beats, we must suppose that the strips set in motion by the two generating tones partially overlap. So long as the generators are near together, we hear only a single tone, — the intermediate tone, due to the superposition of the primary vibrations. The portions of the strips which do not overlap are so small that they cannot vibrate independently and give rise to independent tonal sensations. The beating of the intermediate tone results from the interference of the different oscillatory motions impressed upon the fibres. As the generators diverge, we



hear them sounding smoothly above and below the beating intermediate tone. It is now only a comparatively small portion of the vibrating strips that overlaps; so that the major portions on either side vibrate singly, each in its proper period, and consequently arouse each its proper sensation of tone.

Helmholtz himself explained combinational tones as due to the movements of the drum-skin and ossicles. Attempts have since been made to derive them from the vibration of the basilar fibres; but recent investigation seems to show that Helmholtz may have been right, and that these tones may take their physical origin in the middle ear.

There is nothing in audition that is analogous to colour blindness in vision. On the other hand, the resonance theory receives strong support from pathology. Cases are known in which, while the outer and middle ears are intact, the range of hearing is greatly reduced: all that is left of the tonal scale is a tonal 'island,' extending perhaps over a couple of octaves, perhaps only over two adjacent semitones. Other cases occur in which the range of hearing is normal, but the tonal scale is not continuous; there are tonal 'gaps,' large or small,—parts of the scale where the patient is completely deaf to tonal stimuli, though he can perfectly well hear the tones above and below. Both of these defects of hearing point to the existence, in the internal ear, of a series of end-organs that are separately stimulable by tones of different pitch-number; and end-organs of this sort are provided by the basilar fibres and the hair-cells which they support.

The principal objection urged against the Helmholtz theory is that the basilar fibres are too minutely small to serve as resonators, especially for the tones of the lower region of the scale. To this the reply is made that they are loaded, by the arches of Corti and the adjacent cells, and that their frequency of vibration is thus very considerably reduced. We cannot at present say either that the objection is fatal to the theory or that the reply is convincing in its favour. No other theory has, however, been proposed which covers so wide a range of facts or explains these facts so satisfactorily as the resonance theory.

## References for Further Reading

§§ 23-28. A general summary of facts and theories is given by K. L. Schaefer, professor of physiology at Berlin, in Nagel's *Handbuch*, iii., 1905, 476 ff. More detailed treatment of the subject will be found in the *Tonpsychologie* of C. Stumpf, professor of philosophy at Berlin. On the character of auditory sensations at large, see i., 1883, §§ 10, 11; ii., 1890, § 28: on tone-colour and timbre, ii., § 28: on beats, ii., § 27: on combinational tones, ii., 243 ff., and other passages cited in the index. Another classical work is Helmholtz' *On the Sensations of Tone*, translated by A. J. Ellis, 1895. Parts i. and ii. deal with the subject-matter of these sections; the author's theory is worked out on pp. 128 ff., 158.—Consult also A. Barth, *Zur Lehre von den Tönen und Geräuschen*, in *Zeitschrift f. Ohrenheilkunde*, xvii., 1887, 81; art. *Hearing*, in *Baldwin's Dict.*, i., 1901, 443 ff.; W. Wundt, *Physiologische Psychologie*, ii., 1902, 63 ff., 370.

It has been known for some time that the vowel-sounds of the human voice owe their timbre, not to a regular series of overtones, but to certain concomitant tones, whose pitch remains relatively constant whatever the fundamental may be upon which the vowel is spoken or sung. These tones, called by L. Hermann 'formants,' apparently represent the proper tones of the buccal resonance chambers; they are usually inharmonic both to the fundamental and to one another; and they may attain to a high degree of intensity. Recent investigations, now, seem to show that the timbre of the wind instruments may also be due to the presence of formants: "instead of a characteristic series of harmonics, it seems that each instrument possesses rather a characteristic tone or tones . . . of constant pitch for all notes of its scale" (D. C. Miller, *Science*, N. S., xxix., 1909, 171; cf. R. Wachsmuth und G. Meissner, *Arch. f. d. gesammte Physiologie*, cxvi., 1907, 543; E. Herrmann-Goldap, *Annalen d. Physik*, xxiii., 1907, 979). If this result is confirmed, the account given of timbre in § 25 must be correspondingly modified. Negative results have, however, been obtained by W. Köhler, *Akustische Untersuchungen*, in *Zeits. f. Psych.*, liv., 1909, 241 ff.

## SMELL

§ 29. **Sight and Hearing: Taste and Smell.** — If you were asked to make out a list of the senses, you would probably begin with sight and hearing. These two seem, naturally, to go together: they are the 'higher' as contrasted with all the other, 'lower' senses. The word 'higher' may then mean one of two things: that the sense-organs, eye and ear, have attained to the highest degree of biological development; or that the sensations derived from them are put to the highest intellectual purposes. The second meaning is, perhaps, that which is the more familiar to common sense. Sight and hearing have an obvious twofold value to the organism: a commercial value, as the vehicle of communication, of written and spoken language; and a cultural value, as the vehicle of the fine arts, painting and sculpture, literature and music.

From this point of view, the bracketing together of sight and hearing is both natural and right: only, of course, while we talk in terms of common sense, we must think in terms of parallelism. On the other hand, it is worth while to remember that, psychologically, the differences between the two senses are very great. Visual sensations form a manifold of three dimensions; sensations of tone, a manifold of two dimensions. Colour mixtures appear themselves as simple sensations, while mixtures of tones are analysable into their constituents. Again, there is no

such thing as tonal contrast, or a negative after-image of tone. The phenomenon of beats has been compared to that of flicker; but there is nothing in vision that resembles the combinational tones. And when we turn from description to explanation, we find that antagonism is the keynote of visual, and sympathetic resonance the keynote of auditory theory. — We may sum up these differences between sight and hearing, in a single word, by saying that the former is a chemical and the latter a mechanical sense.

Next after sight and hearing, in a list of the senses, stand taste and smell. These, too, seem to go together as a matter of course. Psychologically, indeed, they have good right to go together. Both alike are chemical senses, and the two groups of sensations are intimately connected in experience: so intimately, that in everyday life we are constantly attributing to taste what really belongs to smell. Most meats and vegetables are tasteless. If you hold your nose, you cannot distinguish a bit of apple from raw potato, or vinegar from claret. A cold in the head does not affect taste, as we ordinarily suppose; what really happens is that the accumulation of mucus in the nose cuts off the sense of smell. It is clear that such gross confusion would not be possible unless the qualities of taste and smell were very much alike: nobody would confuse a colour with a tone! As a matter of fact, it may well be doubted if the scent of lavender and the taste of sugar do not stand, psychologically, nearer together than the taste of sugar and the taste of quinine.

On the biological side, also, the senses of taste and smell are closely related. Both of them, though in slightly different ways, stand guard over the great function of nutri-

tion, inviting the organism to what is wholesome and warning it of what is deleterious.

The sense of smell is of peculiar interest: partly on account of the problems which it sets to psychology, and which — as we shall see in the following sections — are still very far from solution; partly on account of the rôle that it has played in the course of organic evolution. Far back in the history of life, among the reptiles, the cortex appears as little more than an annex to the organ of smell. As development proceeded, the sense retained its importance as the servant of nutrition and reproduction: we know, for instance, how largely it bulks in the mental life of the carnivorous mammals. It is, however, essentially a land-sense: the mammals which live wholly or partially in the water — whale, dolphin, seal — possess a very rudimentary organ of smell, and are probably without smell sensations. The sense-organs in fishes which have been described as organs of smell differ in structure from the corresponding organs of land animals, and apparently furnish sensations, not of smell, but of something akin to taste. It is also a ground-sense: birds have, in general, very obtuse smell; and our own disregard of smell sensations is largely due to our assumption of the upright position.

On the other hand, there is no evidence for the statement, often as it is made, that in man the sense of smell is degenerating. Both in range of quality and in discrimination of intensity (§ 66), it holds its own as against the other senses. Moreover, odours still have a high biological importance as appetisers: the smell of cooking makes the mouth water, as we say; and invalids may be tempted to eat by the aroma of the dishes set before them. The significance of smell for nutrition is masked by the fact that, in man, stimulation of the organ from within the mouth, especially in the act of swallowing, is at least as important as its stimulation through the external nostrils; and here, as we have said, all the credit is taken by taste. Whether the sense of smell has any large share, primary or derivative, in the sexual life of man is a disputed point. There are, no doubt, large individual differences in this regard; but, on the whole, the evidence is decidedly in the affirmative.

re + value

smell

of the  
Hollingworth + Pfefferberg

Ch. Bl

§ 30. **The Olfactory Qualities.** — The sense of smell, like the senses of sight and hearing, includes a very large number of qualities of sensation. It is impossible to say, at present, what this number is; we know too little about the world of odours to be able to undertake its systematic exploration. Indeed, the number may always remain indeterminate, since new odours are constantly added to the list. The progress of chemistry and of the arts that depend upon it means the continual discovery of odorous substances; and every experiment upon the cultivation of flowers and fruits may, in favourable climatic conditions, furnish a new perfume.

Under these circumstances, we can do no more than give a provisional classification of the smell qualities, based on their introspective resemblances. The following division into nine classes dates, in the main, from the great Swedish naturalist Linnaeus.

1. *Ethereal or Fruit Odours.* — All fruit and wine odours; the scents of the various ethers; the smell of beeswax.
2. *Aromatic or Spice Odours.* — All spicy smells: camphor, turpentine, cloves, ginger, pepper, bay leaves, cinnamon, caraway, anise, peppermint, lavender, bitter almonds, rosemary, sassafras; thyme, geranium, bergamot; rosewood, cedarwood, etc.
3. *Fragrant or Flower Odours.* — All flower scents; vanilla, tonka bean, tea, hay; gum benzoin, etc.
4. *Ambrosiac or Musky Odours.* — Musk, ambergris, sandalwood, patchouli.
5. *Alliaceous or Leek Odours.* — Onion, garlic, asafoetida; india-rubber, dried fish, chlorine, iodine.
6. *Empyreumatic or Burned Odours.* — Roasted coffee, toast, tobacco smoke, tar, burned horn, carbolic acid, naphthalene, benzine, creosote.



7. *Hircine or Rank Odours*. — Stale cheese, sweat, valerian, root and stem of barberry and black currant, lactic acid, caproic acid.
8. *Virulent and Foul Odours*. — Opium, laudanum, French marigold, fresh coriander seeds, bed bugs, squash bugs.
9. *Nauseous Odours*. — Carrion flowers, stinkhorns, water from wilted flower stems, decaying animal matter, faeces.

All of these classes may be further subdivided, and in some cases the subdivisions may themselves be split up into still smaller groups. It is, however, unnecessary to go into more detail. The list is unsatisfactory, first, because there are many odours that cannot certainly be classed under any one of the nine headings; and, secondly, because the odours under certain headings (1 and 3, or 2 and 4) seem to be more nearly related than are particular odours under a single heading (2 or 6). Nevertheless, it serves to give an idea of the immense range and variety of the olfactory qualities.

Many of the stimuli mentioned in the list have sensory effects that extend far beyond the domain of smell. Thus the two ordinary anaesthetics, chloroform and ether, belong as scents to the ethereal group. But, further, inhaled chloroform tastes sweet, and inhaled ether bitter; while both stimuli may, by diffusion, give rise to sensations of cold and, by direct application, to sensations of pain. Pungent odours (ammonia, pepper, mustard) arouse pricking or tingling sensations in the nose and throat. The smell of onions and of horse-radish brings tears to the eyes; in some cases, the smell of hay or of newly turned garden mould has an unpleasant effect upon breathing. Odours of the eighth and ninth classes may excite the sensation of nausea. — In view of these facts, it becomes necessary for us to raise the question of the essential nature of the olfactory stimulus, and of its mode of action upon the organ of smell.



§ 31. **Olfactory Sensation and Olfactory Stimulus.** — Sensations of smell are aroused, not by the transmission of wave-motions through air or ether, but by the actual contact of material particles with the sense-organ. The odorous particles may be given off by volatile substances in our immediate surroundings, or may be brought from a distance by currents of air. They are received into the nose in the act of inspiration: if we wish to get the full fragrance of a flower, we sniff at it; so long as we hold the breath, we smell nothing. It follows that all smell stimuli must exist in the form of gas or vapour; solids and liquids are odorous only if they are also volatile.

breath  
 N.B.

Sensations of smell may also be set up by way of the posterior nares: especially is this the case, as we have said, in the act of swallowing. If scented air is inhaled through the mouth, and expired through the nose, the scent will be clearly perceived, though there is some loss of intensity due to the adhesion of odorous particles to the moist lining of mouth and throat.

swallow

It is possible, though it is by no means easy, to drive out all the air from the cavities of the nose, and thus to bring an odorous liquid into direct contact with the organ of smell. Experiments of this sort have been made, but with uncertain result. Even if we grant, however, that liquid stimuli can arouse sensations of smell, it would still remain true that the normal olfactory stimulus has the gaseous form.

There can be no doubt that the action of stimuli upon the organ of smell is chemical in its nature, so that a substance is odorous or inodorous by virtue of its chemical constitution. Many attempts have been made to express this fact in precise terms, — to discover precisely what sort of molecule is able to arouse an olfactory sensation. No single or general law has as yet been found. The following results show, however, that the prospect is not hopeless.

In the first place, it is agreed by most investigators that the chemical elements are inodorous. True, exceptions to the rule (chlorine, bromine, iodine) at once suggest themselves. It is probable, however, that these substances become odorous only in combination with the hydrogen of the air in the nasal cavities. If the rule holds, our field of search is so far restricted; we may neglect the atom, and turn our attention solely to the molecule.

— Secondly, all odorous substances (with one exception) are derived from the trivalent, divalent, and univalent elements of the fifth, sixth, and seventh groups.<sup>1</sup> The single exception is given with the great group of the hydrocarbons. The real odorous substance in their case may, however, be a product of oxidation. Again, therefore, if the rule holds, our field of search is restricted; we may confine our attention to molecules which contain certain elements from group V., VI., or VII.

It must be confessed that these two rules, even if strictly valid, do not take us very far. Detailed study of the chemical composition of substances of like odour, and of the odour of substances of like chemical composition, does not, as yet, take us much farther. One point is worth mentioning: it has been found that the homologous series of organic chemistry furnish, within limits, series of related but progressively diverging odours, so that likeness or difference of smell runs roughly parallel to likeness or difference of chemical constitution. An illustration will make this rule clear. The series of fatty acids begins with formic ( $\text{CH}_2\text{O}_2$ ), acetic ( $\text{C}_2\text{H}_4\text{O}_2$ ), propionic ( $\text{C}_3\text{H}_6\text{O}_2$ ), butyric ( $\text{C}_4\text{H}_8\text{O}_2$ ), valeric ( $\text{C}_5\text{H}_{10}\text{O}_2$ ), caproic ( $\text{C}_6\text{H}_{12}\text{O}_2$ ). All these substances have related

<sup>1</sup> A statement and explanation of the periodic law, and a table of the elements arranged in accordance with it, will be found in any good encyclopaedia. The important elements are: V. nitrogen, phosphorus, arsenic, antimony, bismuth; VI. oxygen, sulphur, selenium, tellurium; VII. fluorine, chlorine, bromine, iodine. Their serial positions should be noted.

odours, which become increasingly different with increasing distance between the terms of the series. Moreover, the odour, which in formic acid is weak, grows stronger and stronger as the series advances. Presently, however, the olfactory quality rather abruptly lapses: the higher acids — palmitic ( $C_{16}H_{32}O_2$ ), margaric ( $C_{17}H_{34}O_2$ ), stearic ( $C_{18}H_{36}O_2$ ), etc. — are almost or entirely inodorous. — As things are, theory can do little with these and similar facts; but it is clear that, if such uniformities occur, a chemistry of smell must in the long run be possible of achievement.

In fine, then, we cannot correlate olfactory quality with the configuration of the molecule, as we can correlate visual quality with the wave-length of light, and auditory quality with the wave-number of sound, though we may hope that some day a chemical correlation will be made out.

§ 32. **The Dependence of Olfactory Sensation upon the Composition and Time-relations of Stimulus.** — Sight and smell are both chemical senses. We may, therefore, expect to find a certain resemblance in the mode of behaviour of their sense-organs. How far the resemblance goes, we shall discover only by experiment; but we may safely look to sight for guidance in our first investigations of smell. —

Two colours that are mixed in accordance with the first or second law of colour mixture either neutralise each other or produce a new, intermediate colour. What happens if we mix two odours?

We may proceed in two ways: we may conduct the odours separately to the two nostrils, by means of the olfactometer; or — if chemical combination does not occur

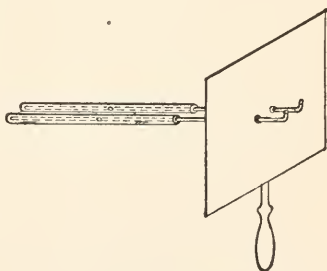

FIG. 18. Double Olfactometer (solid stimuli).

— we may make a mechanical mixture of the odorous substances before smelling. In both cases, we obtain results analogous to those got by the mixture of colours.

First, there are undoubtedly odours which, if mixed in the right proportions, neutralise each other. Bridal bouquets often have gardenia mixed with their orange-blossoms, in order that the aromatic scent may weaken the too powerful fragrance. Tooth-powder of orris root is used to counteract the foetor ex ore. In medical practice, and in the operating room, recourse is had to this principle of compensation: balsam of Peru offsets the smell of iodoform, and carbolic acid the stench of pulmonary gangrene. Laboratory experiments yield the same result: the odour of red india-rubber, for instance, neutralises the

odours of cedarwood, gum benzoin, paraffin, beeswax, tolu balsam, etc.

Secondly, there are odours which, if mixed in the right proportions, give rise to a resultant odour, a new olfactory quality. Most of us have noticed that the addition of a few fragrant leaves to a bunch of flowers may alter the scent of the whole bouquet; that the mixture of two toilet perfumes may produce a perfume different from

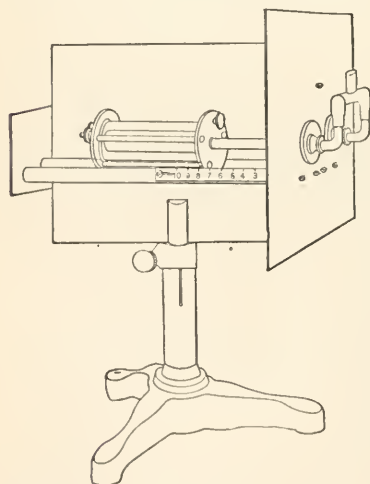

FIG. 19. Double Olfactometer (liquid stimuli).

either; that the attempt to overpower a foul or nauseous odour by a perfume will sometimes set up a scent more

sickening than the first. Laboratory experiments bear out this conclusion: new odours arise, for example, from the mixture of musk and opium or listerine, iodine and ylang ylang or camphor, valerianic acid and lavender or hyacinth. In all such cases the resultant odour is simple and unanalysable; it resembles the component odours, but it cannot be resolved into them.

Whether odours have a constant mixing value, independent of their mode of origin, — whether, that is, we have in smell an analogue of the third law of colour mixture, — cannot be said with certainty. The trend of evidence appears to be towards the affirmative.

The likeness between these results and those of colour mixture is evident. Nevertheless, there are striking differences. Thus, smell mixtures are, in general, much less stable than colour mixtures. Experiment shows that two odours rarely neutralise each other completely for more than a few seconds; it is easy to obtain an unsaturated odour of the quality of the stronger component, but not easy to get actual extinction. This seems to mean that the chemical equilibrium of the olfactory cells is less stable than that of the retinal cones. In the same way, the new odour resulting from a twofold mixture is often transitory in character, giving place either to the odour of a single component or to an oscillation of the two. This is due, in many instances, to the fact that the sense-organ becomes more quickly adapted to the one stimulus than to the other, or that the substances mixed are not equally volatile; but in others it also seems to point to a chemical instability of the olfactory cells. Resultant odours of a more permanent kind may be secured by the mixture of a number of components. The flower perfumes of the perfume industry are, as a rule, quite complicated mixtures: heliotrope, for example, is derived from the mixture of vanilla, rose, orange-flower, ambergris and almond.

Again, it is impossible to draw a sharp line of division between

complementary odours and odours that combine. We should naturally expect that the members of the same or of related classes would mix, and that the members of diverse classes would cancel one another. Some ten years ago, a statement to this effect would have found support in the composition of toilet perfumes, in pharmaceutical practice, and in the results of psychological experiment. Recent work has proved, however, that no such rule can be laid down: odours of the second and eighth classes, for instance, may combine as readily as odours within either group, and odours taken from the same class may behave as complementaries. Evidently, there is in smell no such clean-cut principle of antagonism as we have found in sight.

*adaptation*

The fact of adaptation to stimulus is, perhaps, more in evidence in the case of smell than it is even in that of vision. Odours of the most insistent kind fade out, if only the stimulation is kept up without intermission, in a comparatively short time. Workers in tanneries, cheese warehouses and fish markets, garbage collectors, habitual smokers, patients with iodoform dressings, medical students in the dissecting room, — these persons are, as a rule, quite unconscious of the odours that surround them. All of us have, probably, at one time or another, been asked to go into a certain room and “see if we don’t smell fire,” and have noticed that, after a few vigorous sniffs, we were wholly unable to say whether we did or did not. Laboratory experiments simply make these observations more precise. Thus, heliotrope becomes inodorous if smelled for about 5 min.; asafoetida in  $1\frac{1}{2}$  min.; stale cheese in 8 min.; and so on.

Here, too, there are marked differences between smell and sight. The fading out of a given sensation does not mean the arousal of its complementary; there is no negative after-image of smell; adaptation to india-rubber does not leave us with a

scent of cedarwood or tolu or beeswax. The effect of adaptation is simply to increase our sensitivity for certain odours, and to reduce or destroy it for others. Thus, it has been found that a partial adaptation to cedarwood or tolu or beeswax renders the nose more sensitive to the smell of india-rubber, while partial adaptation to glycerine soap or cocoa butter or Russian leather has no such effect. On the other hand, adaptation to iodine leaves us insensitive to the odour of eau de Cologne, absolute alcohol, heliotrope, oil of caraway. In this way, a continuous adaptation of the sort mentioned above may materially change the world of odours: the user of perfumery, the smoker, the hospital attendant, will be peculiarly susceptible to certain scents and peculiarly obtuse to others. There is, of course, a possibility that the sense of smell as a whole may be blunted by the repeated application of the same stimulus.<sup>1</sup>

§ 33. **Theory of Smell.**—The organ of smell<sup>2</sup> is extremely simple. It consists of a patch of brownish mucous membrane, not much larger than one's little-finger nail, which lines the roof and part of the walls of the extreme upper portion of the nasal cavities. This terminal pouch is so narrow and so remote that the air current of respiration does not reach it; the olfactory epithelium can be stimulated only by diffusion or by eddies from the main stream. The olfactory cells are set amongst columnar supporting cells; they are very slender, possess a large nucleus, and are prolonged peripherally as rod-shaped processes ending between the columnar cells at the free surface of the epithelium.

<sup>1</sup> It is said, in recent text-books, that smokers possess only about  $\frac{2}{3}$  of the normal sensitivity to odours. The statement is apparently taken from H. Griesbach, who in 1899 published a comparative study of the senses of hearing, smell and touch in the blind and the seeing (*Archiv f. d. gesammte Physiologie*, lxxiv., 577; lxxv., 365, 523). But Griesbach worked only with india-rubber!

<sup>2</sup> The author uses the Deyrolle model, *Coupe médiane du nez grossi.*



This simplicity of structure suggests at once that the organ of smell must respond to olfactory stimulus in the same sort of way as the eye to light, and not as the ear to sound. For every sensation of tone we find a separate structure in the cochlea. On the other hand, all the sensations represented in the colour pyramid are derived from the six antagonistic processes in the cones (*Bk-W*, *B-Y*, *R-G*) and from the cortical grey. Our daylight vision, rich as it is in sense qualities, depends simply upon four chemical reactions, three reversible and one constant. Now a theory which, like the theory of vision, reduces the manifold of psychological elements to a small number of elementary psychophysical processes is termed a theory of components. Black, white, grey, and the invariable *R*, *G*, *B* and *Y* are the components of our visual theory: psychophysically, they are the elements of vision, though psychologically they are no more elementary than orange or violet or purple. It is important to bear this distinction in mind.

We may expect, then, that the right theory of smell will be a component theory. This expectation is borne out by the fact, already mentioned in § 32, that adaptation to a particular odour leaves us insensitive to some, while it does not impair our sensitivity to other odours. The odours that are killed by adaptation to iodine, for instance, evidently require for their arousal the same psychophysical processes: they stand to iodine in much the same relation that rose, lilac, mauve, heliotrope, purple bear to violet. If, therefore, we could work over the whole range of olfactory qualities, and find out which are weakened or blotted out, and which are left intact, by adaptation to the various odours taken singly, we might hope to discover

the psychophysical elements of olfactory sensation. Indeed, the programme need not be made so comprehensive: if we could work systematically with even a few odours, selected from all the nine classes and their recognised subdivisions, it is probable that the outlines of a component theory would emerge from our results.

The work is, however, exceedingly laborious, and consumes a great deal of time. Something has been done; very much more remains to do. It has been calculated, on the basis of our present knowledge, that 30 or 40 specific chemical processes must be assumed for the sense of smell,—many more than for daylight vision. It is unlikely that there are 30 or 40 kinds of olfactory cells. But whether there are, say, 10 sorts of cells, each the seat of 3 or 4 processes, or 3 or 4 sorts of cells, each the seat of 10 different chemical processes, we have no possible means of deciding.

While these phenomena of adaptation afford the strongest support to a component theory, they do not by any means stand alone. It is clear that the results of smell mixture—resultant odours and compensations—point in the same direction, as does also the mere fact that odours may be grouped, by their introspective resemblances, into a number of distinct classes. Further evidence comes from pathology. In cases of partial anosmia, which occurs both as congenital defect and as the consequence of influenza, diphtheria, etc., the patient is insensitive to some and sensitive to other odours: thus, the musky odours or the vanilla-group of the fragrant odours may be destroyed or weakened, while all the rest persist in their normal character. Cases of parosmia, or subjective perversion of the sense of smell, fall into similar groups, which, so far as they have been investigated, appear to correspond with the fourth, fifth, sixth and ninth olfactory classes.

## References for Further Reading

§§ 29-33. *Die Physiologie des Geruchs*, 1895, by H. Zwaardemaker, professor of physiology at Utrecht; J. Passy, *Revue générale sur les sensations olfactives*, in *Année psychologique*, ii., 1896, 363 ff.; W. Wundt, *Physiologische Psychologie*, ii., 1902, 46 ff.; W. Nagel, *Der Geruchssinn*, in *Nagel's Handbuch*, iii., 1905, 589 ff.

## TASTE

§ 34. **The Gustatory Qualities.** — For the most part, sensations of taste come to us blended with sensations of smell, touch and temperature. These blends have a curiously unitary character: it is only by directing the attention, in the light of past experience, first to one and then to another aspect of the given whole, that we can distinguish the separate components. Thus the flavour of a peach, or of black coffee, seems to be simple and unique; but we may happen to notice the aroma before we begin to taste, and in this way take an involuntary first step towards analysis. At times, the difference between smell and taste comes to us with a sort of shock; the bitter taste of unsweetened chocolate, for instance, is in sharp contrast to the aromatic odour. Again, we may remark that our food to-day is more savoury than it was yesterday, when our nose was stopped up with a cold; or we may discover that the repulsive flavour of certain medicines, such as castor oil, is avoided by the simple expedient of holding the nose. In all these cases, and in many others like them, everyday experience plays into the hands of psychological analysis. Smell and taste are, after all, separate senses with separate sense-organs; and while a blending of their sensations is the rule, occasions are bound to arise when we taste without smelling or smell without tasting.

There is no such natural separation of taste from touch and temperature. It is, however, not difficult to observe that in oily and fatty tastes we have something that is precisely like the feel of greasy fingers, and in pungent and biting tastes something that is precisely like the pricking of pungent odours in the nose or the bite of mustard-plaster upon the skin. The cold of ice-cream in the mouth is the same as the cold of icy water to the hands; and when a too hot soup scalds the tongue we have — apart from the impairment of taste itself — the same sensations as when we step into a too hot bath. Having made these observations, we are able to single out, by the attention, the touch and temperature components in ordinary tastes.

If the taste-blends are thus analysed, and the foreign constituents referred to the sense-departments to which they properly belong, there remain only four qualities of taste: sweet, bitter, sour and salt. Here is poverty indeed, as compared with the wealth of sight, hearing and smell! — and a poverty all the more striking, since taste makes so brave a show of variety in everyday life.

This result depends, not only upon introspective analysis of the taste-blends, but also upon a systematic exploration of the organ of taste with very various kinds of stimulus. Before the experimental tests were made, the lists of gustatory qualities put forward by different authors were, as we should expect, widely different. It would, however, be a mistake to suppose that they have grown steadily shorter as analysis has advanced. None of them are very long. Smell, indeed, seems to have been practically eliminated almost from the outset, though some physiologists speak of aromatic tastes, foul tastes, etc., and it is odd that the rule of holding the nose during experiments on taste was laid down for the first time by the French chemist M. E. Chevreul as late as 1824. On the other hand, the touch and temperature components evidently

the relative  
value of  
temperature

presented great difficulty. We find oily tastes, pungent tastes, smooth tastes, astringent tastes, etc., figuring in the scheme of taste qualities; and contrariwise we find sour and salt transferred, on account of their astringent and burning character, from the sense of taste to that of touch. Here, then, are give and take, addition and subtraction: Linnaeus brought the number of tastes up to 10, but a recent investigator<sup>1</sup> who reduces them to 2 (sweet and bitter) is merely repeating what had been said sixty years earlier.<sup>2</sup>

It was long supposed that nausea is a taste quality; this view was taken, for instance, by so great a man as Johannes Müller, the father of modern physiology, on the ground that the sensation aroused by pressure on the base of the tongue—putting your finger down your throat—cannot be identified with any quality of touch.<sup>3</sup> At the present time, many psychologists incline to the view that the alkaline and the metallic tastes must be regarded as elementary qualities of taste; but tests made with the nose closed prove that the irreducible factor in both cases is due to smell.—

If smell is ruled out, the ordinary taste-blends may be analysed as follows. Sour is at first astringent; then, as it becomes stronger, burning; finally, purely painful. Salt is attended by a weak burning, which does not rise to positive pain. Sweet brings with it the perception of smoothness and softness; at high intensities of stimulus, it pricks or gives a sharp burn. Bitter suggests something fatty; at high intensities it may burn.

§ 35. *Gustatory Sensation and Gustatory Stimulus*.—In order to be <sup>tastable, necessary</sup> ~~sapid~~, a substance must be, to some extent, soluble in the saliva of the mouth. If this condition is fulfilled, it may exist in any form, as solid or liquid, vapour or gas.

There are, however, soluble substances which are taste-

<sup>1</sup> W. Sternberg, *Geschmack und Chemismus*, in *Zeitschrift f. Psychologie u. Physiologie d. Sinnesorgane*, xx., 1899, 387.

<sup>2</sup> By L. H. Zenneck in J. A. Buchner's *Repertorium f. d. Pharmacie*, lxxv. (2te Reihe, xv.), 1839, 224 ff.

<sup>3</sup> *Handbuch der Physiologie des Menschen*, ii., 1840, 489.

less. We are thus thrown back, as in the case of smell, upon the question of chemical constitution, and must try to work out a correlation between stimulus and sensation in chemical terms. Now chemistry uses the terms salt, acid, sugar as class-names for related groups of compounds. All three words — as well as the phrase 'bitter principles,' which is employed in pharmacy and in organic chemistry — are borrowed from the sense of taste; and we can say off-hand, from ordinary experience, that acids generally taste sour, salts salty, and sugars sweet. A little enquiry brings out the further fact that the bitters with which we are most familiar are alkaloids. Can we, then, correlate the four taste qualities with these four types of chemical combination?

Unfortunately, the rule has puzzling exceptions even in the cases of sour and salt. It is true that we get the taste of salt only from chemical salts: but there are chemical salts that taste sweet, others that taste bitter, and others again that have no taste at all. It is also true, apparently, that we get the taste of sour only from chemical acids, or from substances that contain acids: but there are acids that taste sweet, acids that are tasteless, and at least one acid (hydrocyanic) which is said to taste bitter. The suggestion has been made that the sour taste of the majority of acids may be accounted for by their ionisation in aqueous solution, — may be ascribed, that is, to the setting free of the common ion hydrogen. Hydrocyanic acid is only partially ionised, and the tasteless fatty acids like palmitic, stearic and oleic are insoluble in water. — There is undoubtedly a close chemical relation between sweet and bitter; a very slight change of chemical constitution will change the one taste into the other. The groups of sweet-tasting and



bitter-tasting substances are, however, extremely heterogeneous.

In fine, then, much detailed work is needed, in taste as in smell, before any general law of the correlation of stimulus and sensation can be made out.

It has been pointed out that the inorganic sweet-tasting substances are derived from elements of the III., IV. and V. groups, and that these elements are, so to say, double-faced, since they combine with acids as bases and with bases as acids to form salts. On the other hand, the inorganic bitter-tasting substances are derived from electropositive elements of the I. and II., and from electronegative elements of the VI. and VII. groups. Here is the hint of a principle, which may perhaps be carried over to the organic compounds, and it has, in fact, been maintained that all the sweet-tasting organic substances have this double,  $\pm$ -character, while all the bitter-tasting — though closely related to them — have either the *plus* or the *minus* sign. If the rule holds, we can readily understand that a slight change of the sweet-generating molecule will transform it into a generator of bitter. However, it is best to be on one's guard against premature generalisation.

§ 36. **Mixtures and Adaptations.** — We know, from everyday experience, that certain tastes are more or less antagonistic. Sugar moderates the bitter taste of coffee and chocolate, and the sour taste of unripe fruit. Sour and salt offset each other, to a certain extent, in sour pickles and salad dressings. Salt corrects the too luscious sweetness of an overripe melon. On the other hand, bitter and salt may exist side by side, as in the taste of olives; and bitter and sour, as in that of a green peach.

Observations of this sort are, however, unsatisfactory. First of all, the act of eating or drinking brings the taste-stimulus into contact with the whole surface of the tongue. If, then, the particular stimulus contains salt and bitter,

we may have the sensation of salt set up at a part of the tongue which is especially sensitive to salt, and the sensation of bitter at another part, especially sensitive to bitter: the two qualities will thus appear side by side, just as a blue and a yellow may appear side by side in the field of vision. To obtain assured results we must apply the mixed stimulus at one and the same point. Secondly, the four taste-qualities require different times for their arousal: salt comes first, then sweet, then sour, and bitter last. It is quite possible that, in ordinary life, these time-differences escape notice, so that we may regard two tastes as occurring together when really they occur in succession. And thirdly there is no guarantee, under the conditions, that stimuli are mixed in the right proportions. For all these reasons, we must have recourse to experiment.

A careful study of taste-mixtures in the laboratory brings out the following facts. With high intensities of stimulus, the two tastes seem not to influence each other; they simply oscillate. With low intensities, there is in most cases a partial compensation, which is least for sweet and sour, better for salt and bitter, better still for sour and bitter, sour and salt, and sweet and bitter. The antagonism is not so clean-cut as it is in the case of sight; we rarely, if ever, obtain actual neutralisation of two compensatory tastes. Only in one instance, the mixture of sweet and salt, is there any reminder of the second law of colour mixture. If salt is added, little by little, to a weak sweet, there presently emerges a taste which is neither salt nor sweet, but flat and vapid.

We remarked in § 34 upon the curiously unitary character of the taste-blends. It is worth noticing here that the unitariness persists in spite of the antagonistic nature of the taste qualities.

Think, for instance, of the flavour of a ripe peach. The ethereal odour may be ruled out by holding the nose. The taste components — sweet, bitter, sour — may be identified by special direction of the attention upon them. The touch components — the softness and stringiness of the pulp, the puckery feel of the sour — may be singled out in the same way. Nevertheless, all these factors blend together so intimately that it is hard to give up one's belief in a peculiar and unanalysable peach-flavour. Indeed, some psychologists assert that this resultant flavour exists; that in all such cases the concurrence of the taste qualities gives rise to a new, basic or fundamental taste, which serves so to say as background to the separate components. There is, however, no need to make any such assumption. It is an universal rule in psychology that, when sense-qualities combine to form what is called a perception, the result of their combination is not a sum but a system, not a patchwork but a pattern. The parts of a locomotive form a system; the colours of a carpet form a pattern: in neither case is there a mere heaping together of materials. The same thing holds of perception. Hence, just as it would be absurd to say that the plan of the locomotive is a new bit of steel, or the pattern of the carpet a new bit of coloured stuff, so is it wrong to say that the peach-character of a certain taste-blend is a new taste quality. This character shows us the pattern of the blend, the specific way in which the components are arranged; it is not itself a sensation. — We shall return to the general question later, in § 104. (pp. 371/2)

It was pointed out in § 29 that there is an intrinsic likeness between the sensations of taste and of smell. This fact is clearly recognised in pharmacy. Thus, we are advised to take castor oil or cod-liver oil in claret or lemonade; the sour taste corrects the nauseating or hircine odour. Quinine, which tastes bitter and has no smell, is corrected by essence of orange peel, which has an aromatic smell and no taste. In all sorts of children's medicines, a disagreeable odour is offset by a sweet taste, or a disagreeable taste by some pleasant odour. The result obtained is, of course, only partly due to the cancellation of sensations. When a child has fallen down and hurt itself, we try to turn its attention to

something else : we tell it a fairy story, or give it a lump of sugar, and the crying stops. The same principle, of distraction of attention from the unpleasant to the pleasant, plays its part in these medicinal mixtures. On the other hand, adults are less suggestible than children, and the corrections hold for us as for them ; while an attempt to offset the stench of castor oil, say, by a popular melody or a comic picture would strike us as laughable. Undoubtedly, then, sensations of taste and smell are sufficiently alike to exert a direct influence upon one another. This conclusion loses much of its strangeness if we remember that, phylogenetically, taste and smell are simply two departments of a single chemical sense, the one differentiated for the reception of liquid, and the other for that of gaseous stimuli.

*contains both taste & smell*

Adaptation to tastes is less obvious than adaptation to odours. It seems that the organ of taste is more resistant, chemically more stable, than the organ of smell. Apart from this, however, our attention, in eating and drinking, is largely taken up with the smell and touch components of the taste blends. Besides, we usually have at hand the materials (salt, sugar, vinegar, etc.) for raising the intensity of taste stimuli ; we reach instinctively for the salt-cellar or the vinegar cruet as soon as we miss the taste of salt or sour. Nevertheless, there are times when the fact of adaptation stands out clearly enough. An orange that would taste sweet at the beginning of a meal tastes unpleasantly sour if we take it after a sweet pudding. A stock soup that is at first disagreeably salt gets better after the first few spoonfuls. If we have the courage to attack a plate of early strawberries without sugar, we soon grow accustomed to the acid. — These observations are confirmed by the results of experiment.

In smell, the effect of adaptation is to increase our sensitivity for certain qualities, and to reduce or destroy

it for others. In taste, where there are but four qualities, the negative result of adaptation is generally confined to the quality of the stimulus itself: adaptation to bitter weakens or abolishes the taste of bitter, but leaves the rest at least as strong as they were before. There are, however, exceptions to this rule. If the tongue is painted with a fitting solution of cocaine hydrochlorate, we lose first the quality of bitter, and then that of sweet; if it is painted with gymnemic acid, we lose first the quality of sweet and then that of bitter; in both cases, salt and sour persist. The action of these substances upon the end-organs has not been explained. — The positive results of adaptation must be stated with some reserve, since there are great individual differences among observers. It seems, however, that adaptation to any one of the three tastes }  
sour, sweet, salt affects the remaining two: a foregone }  
sour, for instance, enhances a present sweet or a present }  
salt, and so on. }

The sense of taste appears, further, to show phenomena of contrast, more or less akin to those of vision. A sour applied to the one side of the tongue brings out, for certain persons, the taste of a subliminal sweet applied to the other side. Contrasts may also be obtained, in laboratory practice, between salt and sour, and salt and sweet. On the other hand, subliminal bitter, applied at the same time as sweet, sour or salt, is usually sensed, if at all, as sweet; and supraliminal bitter is, from the first, strong and insistent. cont

Nothing is definitely known about after-images of taste. Many sweet stimuli leave a bitter taste in the mouth; but this may be due to the chemical relationship of the sweet-tasting and the bitter-tasting substances of which we spoke in § 35. It is note-

worthy that, to many persons, distilled-water, an intrinsically tasteless stimulus, tastes distinctly bitter; to others it may taste sour or sweet. Various explanations have been suggested. The taste may be simply an after-effect of adaptation: the mouth is never entirely free from particles of food. Or it may possibly result from the merely mechanical stimulation of the end-organs, just as a flash of light results from mechanical pressure on the eyeball. Or, again, it may be an associative process, an idea or, as it were, an illusion of taste. This and many similar points in the psychology of taste still await explanation.

§ 37. **Theory of Taste.** — The description given of the olfactory cells holds also for the specialised sensory cells which form the end-organs of taste: they are long, slender rod-cells, with large nucleus, set among supporting cells of the same sort as the columnar cells of the olfactory mucous membrane. The rod-cells are not, however, irregularly distributed between the supporting cells; they are gathered together into flask-shaped structures, which are known as the taste-buds or taste-bulbs. At the centre of the bulb stands a group of rod-cells, intermixed with a few supporting cells; the rod-processes converge peripherally to the pore of the bulb. Next comes a wrapping of supporting or cover cells; while the outer wall of the bulb is composed of epithelial cells of special form.

The taste-bulbs occur in greatest numbers in the trenches surrounding the circumvallate papillae at the root of the tongue.<sup>1</sup> They occur also along the edges of the tongue, posteriorly in the folds of the regio foliata and anteriorly in the fungiform papillae; and at the tip again in the

<sup>1</sup> The author uses the Deyrolle model, *La langue vue du côté droit*. He knows of no models that show the sense-organs of nose and tongue in enlarged vertical section. The models must therefore be supplemented by charts (e.g., those of Wenzel's *Anatomischer Handatlas*) or lantern slides.



fungiform papillae, the bright red specks which can be seen standing out from the dull pink of their surroundings. The central area of the surface of the tongue is insensitive to taste. In general, the root of the tongue is especially sensitive to bitter, the tip to sweet, and the middle section of the edges to sour.

The distribution of the end-organs of taste in man shows great individual differences. In adult life, functional taste-bulbs are found on the surface of the tongue, with the exception of a central area of varying size, and on the soft palate; less constantly on the arches and veil of the palate and on the uvula; rarely on a portion of the hard palate. They also occur, curiously enough, in the interior of the larynx and on the epiglottis, regions that are not normally stimulated by sapid substances. Their presence here, and on the superior (posterior) surface of the veil of the palate, accounts however for the sweet taste of inhaled chloroform and the bitter of inhaled ether (§ 30). In children, the taste-bulbs extend over the whole surface of the tongue, and are also found in the mucous membrane of the cheeks, — facts that explain, perhaps, the childish tendency to take big mouthfuls.

Why the central area of the tongue should lose its sensitivity, in adult life, is not easy to say. It is clear, however, if we consider the mechanics of chewing and swallowing, that there must be a stagnation of sapid liquid at the back and on the edges of the tongue; and it is clear that this stagnation is assisted by the trenches about the circumvallate papillae and by the folds of the regio foliata. These, then, are the important regions for tasting. They are more important even than the tip of the tongue, which merely samples the substances that enter the mouth; and we find, as a matter of fact, that insensitivity of the tip not infrequently coexists with normal sensitivity of root and sides.

The reduction of the organ has analogies in other departments of sense. In hearing, for instance, the range of sensation is diminished; the highest audible tone is more than an octave higher in childhood than in old age. We may suppose that the shortest



fibres of the basilar membrane gradually lose their elasticity. In smell, again, the acuity of sensation is diminished; children are much more sensitive to odours than adults, though they do not appear to have a wider range of qualities. It is possible that, in the course of years, the olfactory mucous membrane is coated with minute particles of dust, etc., so that the cells are less easily stimulated.

The papillae of the same region do not all react in the same way to gustatory stimuli. Thus, of 39 fungiform papillae, stimulated with salt, sugar, hydrochloric acid and quinine, 4 proved to be wholly insensitive, while 31 were sensitive to sweet, 31 to salt, 29 to sour, and 21 to bitter; one was sensitive only to sweet, and one only to bitter. It seems probable, then, that there are four kinds of taste-bulbs, each one sensitive to a single quality of taste; and that all of these, or three, or two, or only one, may be present in a given papilla.

This hypothesis agrees with the observed facts of taste mixture and of adaptation, and is also borne out by the pathological cases of loss of taste; the ageusia may be complete, or may affect some qualities more than others. On the other hand, it is impossible to say whether the distinction of the four classes of taste-bulbs is absolute. There are no anatomical differences that might help us to a decision. We must suppose that the substance of the taste cells has been chemically differentiated, for the reception of the different forms of stimulus; but we cannot say whether the specialisation of function has been carried to the same point in all taste-bulbs.

It has been suggested that the extreme sourness of the orange eaten after sweet pudding is due to a contrast of feelings; the sour after the sweet is more unpleasant than a sour standing alone. Even, however, if we grant — and the point is more than doubtful — that contrast between feelings occurs, introspection shows that the sour quality is itself intensified; and the explanation is there-

fore to be sought in the sphere of sensation. The sweet-sensitive bulbs have been put out of function by adaptation to the sweet of the pudding, so that the mixed, sweet-sour stimulus affects only the sour-sensitive bulbs. Hence the orange naturally tastes sourer than it does under ordinary circumstances, when the sweet and sour components are able in some measure to offset each other. x

It is more difficult to account for the fact that a sour, etc. applied to the one side of the tongue brings out the taste of a subliminal sweet, etc. applied to the other side. We may, of course, challenge the fact itself. Liquids are apt to run on the surface of the tongue, and it is conceivable that the stimuli used in the experiments spread across the middle line. We know, however, that the terminal radiations of the n. lingualis which supply the one half of the tongue extend across the middle to the opposite half. The two groups of taste-bulbs, though locally distinct, are thus brought into connection at the periphery by their common nerve supply. — Note

Nothing definite is known of the order of development of the taste qualities. A good deal has been made of the fact that sweets cloy and bitters whet the appetite, while salts provoke and sours quench thirst. This, however, is no argument for an original four-fold differentiation of the sense of taste: appetite is governed largely by smell. Some authors regard salt as a quality of late development, on the ground that the word refers to a particular substance, while sweet, bitter and sour are general terms, and that children and uneducated persons often confuse salt with sour. But we find that many primitive languages have no distinctive word for bitter; that some languages use the same word for sweet and salt; and that uneducated persons may also confuse bitter and sour! We have also seen that sour and salt have similar effects upon the organs of touch (§ 34). In view of the unitariness of the taste-blends, it is not surprising, then, that the two qualities should be confused by persons unskilled in introspection.

## References for Further Reading

§§ 34-37. W. Wundt, *Physiologische Psychologie*, ii., 1902, 52 ff.; C. S. Myers, *Taste*, in *Reports of the Cambridge Anthropological Expedition to Torres Straits*, II., ii., 1903, 186 ff.; *The Taste-names of Primitive Peoples*, in *British Journal of Psychology*, i., 1904, 117; H. Zwaardemaker, *Geschmack*, in K. Asher and L. Spiro, *Ergebnisse der Physiologie*, II., ii., 1903, 699; W. Nagel, *Der Geschmackssinn*, in Nagel's *Handbuch*, iii., 1905, 621 ff.

*Looking.*

## CUTANEOUS SENSES

§ 38. **The Skin and its Senses.** — In popular parlance, touch is ranked as a fifth sense beside sight and hearing, taste and smell, and the organ of touch is the skin. Neither the sense nor its organ is very strictly defined. We may say, however, that the word skin denotes the whole membranous investment of the body; it includes not only the skin proper, but also the red area of the lips, the lining of the cavities of mouth and nose, the conjunctiva and cornea of the eye. In so far as this surface is not occupied by organs of special sense, such as taste and smell, it represents the organ of touch. Hence the name touch applies to all the sensations aroused by contact of the bodily surface with objects of the material world. A thing is hard, soft, warm, cold, painful to the touch; it is by touch that we distinguish wet and dry, light and heavy, rough and smooth, yielding and resistant, sharp and blunt, clammy and greasy, motionless and moving.<sup>1</sup> Exception is made, again, only of those properties, such as odour and sapidity, that appeal to special senses. And here, naturally, there is no attempt at analysis; the sting of pungent odours and the bite of pungent tastes — qualities that really belong to touch — are referred to smell and taste themselves.

<sup>1</sup> It is, of course, as plain to common sense as it is to psychological observation that these distinctions are often drawn in terms of sight; we see that a thing is wet or heavy or in motion. What is now under discussion, however, is the feel of objects that are actually in contact with the skin.

Our experience with timbre and with the blends of smell and taste puts us on our guard in the present instance; we shall not, without question, accept wet and dry, rough and smooth, etc. as ultimate qualities of tactual sensation. Instead, however, of working through the list in detail, we may at once clear up a confusion that inheres in the popular notion of touch,—the confusion between sensations from the skin and sensations from the tissues that lie beneath the skin. Pick up a pen from the table, or give a swing to your revolving bookcase, or try to open a window that has swelled with the rain: in every case you will find that the sensations from the skin are blended with internal sensations. Popularly, the whole complex is attributed to the sense of touch; psychologically, the two sets of sensations are different and must be referred to separate senses.

Suppose, however, that the subcutaneous senses are ruled out: the question still remains whether the skin itself is the seat of one or of more than one sense. And introspection favours the second alternative. There is no resemblance, for example, between the hard smoothness and the chill of a bit of ice, or between the rough brittleness and the warmth of new-made toast; we may safely mark off the sense of touch from the sense of temperature. Nor is there, when we reflect upon it, any resemblance between touch and pain. Indeed, the two kinds of sensation are distinct in time as well as in quality: if we dip the hand into very hot water, or take up a very hot plate, we sense the contact appreciably earlier than the pain. It would seem, then, that the sense of touch must also be marked off from the sense of pain.

To go beyond this point, we must have recourse to experiment. The surface of the skin must be explored,

accurately and minutely, with all sorts of stimuli, — mechanical, thermal, electrical, chemical, — and the sensations which it yields must be described and classified. Much work of this sort has been done, and the psychology of the skin, though still unsettled in sundry details, has thus been put upon a firm basis. —

It is found, first, that the surface of the skin is not uniformly sensitive. Sensations can be obtained only from definite spots or points; the remaining area is insensitive. The spots are fixed in their position, so that they always respond in the same way to the same stimulus; they undoubtedly indicate the presence, in the substance of the skin, of separate sense-organs. It is found, secondly, that these spots are of four distinct kinds: they furnish the sensations of pressure, of warmth, of cold, and of prick. In other words, there are four cutaneous senses, — those of pressure, or of touch in the narrowest sense, of warmth, of cold, and of pain. We will take them in order.

What is ordinarily called the sense of touch thus turns out to be highly composite, — a mixture of the sensations derived from four cutaneous and from a number of subcutaneous senses. It follows, of course, that the terms used in current speech to denote qualities of touch are not directly available for psychology. We have words like pressure, contact, prick, sting, soreness, smart, ache, and we must somehow make them serve our scientific purpose. But the selection is not easy, and the same term may, as a matter of fact, mean different things in different books. Hence it is important that the descriptions given in these Sections be verified by actual test: the instruments required are exceedingly simple, and their manipulation is straightforward. The particular name will then stand for a special bit of elementary experience, a particular feel; the analyses of cutaneous complexes will be analyses of concrete sense-material, and not a mere play of words; and, on

the other side, it will be possible by introspective reference to follow the accounts given by authors who employ a different terminology.

§ 39. **The Pressure Sense.** — If with the point of a pencil you brush one of the hairs that are sparsely scattered over the back of the hand, you obtain a weak sensation, of bright quality, which is somewhat ticklish, and which though thin and wiry yet has a definite body. This sensation, which we may term the sensation of contact, is physiologically a weak sensation of pressure. Wherever the skin carries hair,—that is, over about 95 per cent. of the cutaneous surface,—the hair-bulb is the organ of the pressure sense.

Pressure sensations may be studied systematically by means of the horse-hair point shown in Fig. 20. If you

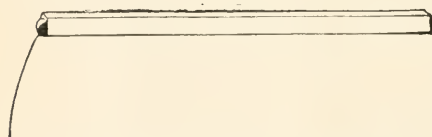

FIG. 20. Horse-hair point, for exploration of the cutaneous surface. A piece of horse-hair, about 2 cm. in length, is attached by sealing-wax to the end of a match.

look at a hair on the back of the hand, you will notice that the shaft runs obliquely into the skin. Just to windward of the hair, directly over the bulb, lies a pres-

sure spot, which is easily found by a few trials with the horse-hair point. By applying the horse-hair to the pressure spot, with different degrees of pressure, it is possible to call out the pressure sensations at different degrees of intensity. You get, first of all, the wiry, bright sensation of the former experiment. As the pressure is increased, the sensation too becomes heavier, more solid: at times it has about it something springy, tremulous, elastic; at



times it appears simply as a little cylinder of compact pressure. Finally, at still higher intensities, the sensation becomes granular: it is as if you were pressing upon a small hard seed embedded in the substance of the skin. The granular sensation is often tinged with a faint ache, due to the admixture of a pain sensation; and is sometimes attended by a dull, diffuse sensation derived from the subcutaneous tissues. It may, however, appear as pure pressure sensation.

If the hairless regions of the skin are explored with the horse-hair point, pressure spots will be discovered which yield the same sensations as the hair-bulbs. The organs of pressure are here to be found in very similar structures, known as the corpuscles of Meissner.

The end-organs of pressure may be stimulated by pressure from without, by traction or pull, and by the wrinkling or stretching of the skin itself. They respond, that is, to any decided change of the local level of pressure, whether the change is positive or negative, rise or fall. They do not, all alike, furnish the graded series of sensations which we have just described, but are, so to say, tuned to different intensities of stimulus, so that a pressure which evokes the granular sensation at one spot may call out only the weak, bright sensation from another. There is, however, no further difference in the nature of their response; all the sensations of pressure belong to this single series.

Pressure spots are found over practically the whole extent of the skin. Their distribution differs in different regions. On the average, there are about 25 of them to the square centimetre; but this number may drop, for instance, to 7 on the upper arm, and may rise to 300 on the scalp.

Adaptation of the pressure sense is a matter of everyday experience. So long as we sit still, we are hardly aware of the pressure of our clothes; and the man who is

looking for the spectacles that he carries on his forehead has become a stock figure in the comic papers. The positive after-images of pressure ordinarily escape notice, since attention turns rather to the object arousing the sensation than to the sensation itself. They may, however, be intensive and of long duration; the deformation of the skin persists awhile, after the removal of the stimulus, and this after-affect of stimulus shows itself in a continuance of sensation.

It seems, at first, hardly credible that the end-organs of pressure should not be differentiated for the reception of different kinds of stimuli. When we think of the great variety of our tactual experience, and when we remember further that the same stimulus has markedly different effects if applied to different parts of the skin, we are almost forced to believe in a number of qualitatively distinct sensations. Nevertheless, the verdict of experiment is decisive here, as it was decisive in the somewhat similar case of taste. And we must not forget the facts on the other side. First, the stimuli that normally affect the skin are areal stimuli, appealing to a group of diversely tuned pressure organs; and the texture of the skin itself, and the nature of the underlying tissues, vary from place to place. There is, then, every chance in ordinary experience for typical differences in the intensity and the temporal course of pressure sensations. Now the sensations which we have termed contact, pressure, and granular pressure, although they are evoked by different intensities of the same stimulus and are on that account usually considered as different intensities of the same quality, are at least as distinct as red and pink, or yellow and orange; and if we may not call them psychological qualities, we must at least say that they do the same service for touch that true qualitative differentiation does for other senses. Secondly, the greater number of normal stimuli affect other organs, cutaneous or subcutaneous, besides those of pressure. Hence most of our tactual experience does, in strictness, consist of more than one quality, because it derives from more than one sense. Thirdly, as has been said above, the atten-

tion is generally concerned rather with the stimulating object than with the sensation which it excites. Here touch borrows from sight in much the same way as taste borrows from smell; visual characters of form, size, texture, etc., are so firmly associated to the feel of the stimulus that the skin gets the credit of a good deal of work done by the eye.

We shall have occasion, in § 50, to analyse some of the commoner tactual complexes. In the meanwhile, this general statement of the various factors which enter into them may lessen the strangeness of the experimental results.

§ 40. **The Temperature Senses.** — If you draw the rounded point of a lead pencil slowly and lightly across the back of the hand, or, better, across the surface of the closed eyelids, you will get, here and there, definite flashes of cold. There is a continuous sensation of pressure, due to the direct or indirect stimulation of pressure spots by deformation of the skin; but this continuum is dotted by sensations from the cold spots.

For systematic work, it is best to use a hollow point of metal, which can be kept at a constant temperature by the passage of a stream of water. The average natural temperature of the healthy skin may be put at about  $33^{\circ}\text{C}$ .<sup>1</sup> With the metal point held at  $12^{\circ}$ – $15^{\circ}\text{C}$ ., one obtains the characteristic sensation from the cold spots, and with the point at  $37^{\circ}$ – $40^{\circ}\text{C}$ ., the sensation from the warm spots. Both are larger, more extended than the sensation of pressure. The cold seems to lance down from above; it is set up at once in its full in-

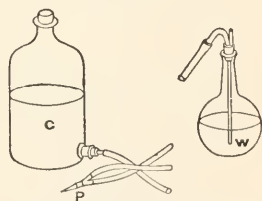

FIG. 21. Apparatus for the investigation of the temperature senses. *C*, cold; *W*, warm water; *P*, metal point.

<sup>1</sup> Degrees C. may be converted into degrees F. by the formula  $\frac{9}{5}\text{C.} + 32 = \text{F.}$

tensity; it might be described as a solid point of cold. The warm often seems to well up from beneath; it is thinner, more diffuse than the cold, and comes gradually to its full intensity.

The end-organs of temperature may be stimulated either from without or from within: from without, by the application to the skin of a cold or warm object, by radiant heat or the proximity of a cold body, by the action of substances like mustard, pepper, alcohol, menthol; from within, by the organic changes occurring

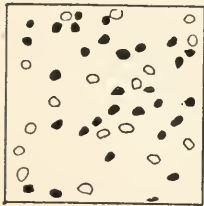

FIG. 22. Cold and warm spots on an area (natural size) of the back of the hand. The dots represent the cold, the circles the warm spots. — M. Blix, 1883.

in fever, in extreme fear, in an access of shame, etc. They respond to any decided change of the local level of temperature, the cold organs if the change is negative, and the warmth organs if it is positive. Like the pressure spots, they are tuned to different intensities of stimulus: some warm spots will give only a lukewarm sensation at  $40^{\circ}$  C., and some cold spots only a cool sensation at  $12^{\circ}$  C. There are no qualitative differences under the general headings warm and cold.

Cold spots may be found, without difficulty, by help of a lead pencil or a carpenter's spike. The warm spots are less easy of determination: partly because the warmed point quickly cools, and partly because the sensations themselves are duller and less insistent than those of cold. This difference of character makes it probable that the warmth organs are deeper seated than the cold organs. The latter may perhaps be identified with the terminal bulbs of Krause, and the former with the corpuscles of Ruffini.

Temperature spots are found, like pressure spots, over practically the whole extent of the skin. The distribution of the three sets of organs differs in different regions. On the average, there are about 13 cold spots and 2 warm spots to the sq. cm.

It is a curious fact that the cold spots, which are not affected by the stimuli ordinarily used in the determination of warm spots,

give a clear sensation of cold if stimulated by temperatures above  $45^{\circ}$  C. This has been termed the paradoxical sensation of cold. Why the end-organs of cold should suddenly respond, at this particular temperature, is not known. Paradoxical sensations of warmth, — sensations aroused at the warm spots by a very cold stimulus, — have never been observed in the normal subject. It may be that they do not occur; or it may be that the end-organs are too deeply set in the skin to be reached by a punctiform cold stimulus. In pathological cases of anaesthesia to cold, the patients will occasionally declare that ice, applied to the skin, feels warm. It is, however, doubtful whether such statements do not rest upon a confusion.

If an areal stimulus of  $45^{\circ}$  C. or over is applied to a part of the skin which includes both cold and warm spots, we have the perception of heat. In general, this appears as a simple and unanalysable quality. It may, however, be analysed by a suitable experimental procedure. Let the stimulus be set, say, at  $40^{\circ}$  C., and gradually increased. At first we get only the sensation of warmth. With a temperature of some  $45^{\circ}$ , the paradoxical cold sensation also appears, and grows stronger and stronger as the rising temperature affects more and more of the cold spots. Under these conditions, it is possible, with practice, to distinguish the two component sensations, though each, as the attention turns to it, seems to be coloured by the other.

The temperature senses have a wide range of adaptation. In the winter we grow accustomed to cold, and in the summer to warmth, so that a warm winter's and a cool summer's day are judged by very different standards. Water that at the first plunge seems unpleasantly cold, and a room that strikes us on our entry as oppressively hot, soon become indifferent; we are even surprised at the comments of later arrivals.

Intensive stimuli, of brief duration, give a positive after-image. A long-continued and intensive cold stimulus is

also followed by an after-sensation of cold. The removal of a continued warm stimulus, on the other hand, leaves a sensation of coolness.

It has been found possible, by experiment, to adapt the fingers to a temperature as low as  $11^{\circ}\text{C}$ ., so that a stimulus of  $12^{\circ}$  feels warm, and again to a temperature as high as  $39^{\circ}$ , so that a slightly lower stimulus feels cold. If the skin is cooled by contact with an object which is kept constantly at  $10^{\circ}$ , the paradoxical cold sensation will be aroused by a stimulus of  $35^{\circ}$ , instead of the normal  $45^{\circ}$ . The following rough experiment gives striking proof of adaptation. Prepare three bowls of water, cold, lukewarm and warm. Hold the hands in the lukewarm water until this feels alike to both. Now place the one hand in the cold, the other in the warm water; let them remain for 1 min. Finally, dip both hands into the lukewarm water: it will seem decidedly cold to the warmed and decidedly warm to the cooled hand.

The after-image of cold following long-continued and intensive cold stimulation is a little paradoxical; we should rather expect an after-sensation of warmth. The cold may, in fact, be the paradoxical cold sensation, aroused in this case by the rush of warm blood to the cold-adapted organs.

§ 41. **The Pain Sense.** — If you hold the shaft of a pin loosely between the forefinger and thumb of the right hand, and bring the point down sharply but lightly upon the back of the left hand, you will sense first the impact itself, and then, after a brief but noticeable interval, something finer, like a prick or a thrill. This second sensation is due to a moderate stimulation of the specific organ of pain.

For accurate results, the skin must be shaved, and softened with soap and water; and the surface must be explored by help of a very delicate hair-point. The sensation obtained from the pain spots then occurs in three stages: first, as a bright, itchy sensation; secondly, as

prick or wiry thrill; and thirdly, as punctiform pain. It is always delicate and lively, and has less body than the sensation of pressure.

The end-organs of pain may be stimulated, from without, by mechanical, thermal, electrical or chemical means. They respond most easily to chemical stimulation, as, for example, to acid

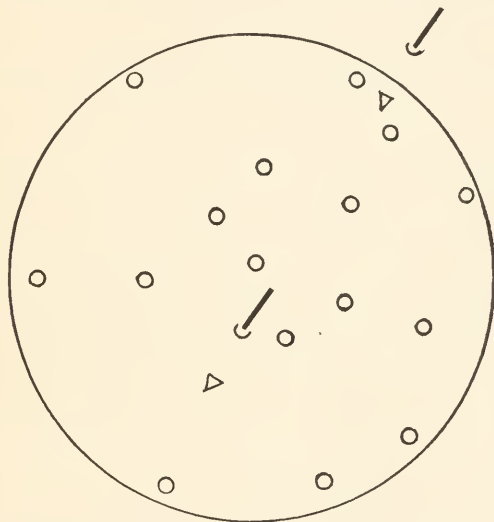

FIG. 23. Pressure and pain spots on an area (here multiplied by 16) of the back of the hand. There are 2 pressure spots and 16 pain spots. The latter are marked as circles, the former as triangles; the hairs to which the pressure spots belong are indicated by the heavy lines and semicircles.—M. von Frey, 1896.

dropped upon the cutaneous surface or to intracutaneous injection of salt solution. They may also be stimulated from within, by the chemical action of substances produced by inflamed tissue. Like the other cutaneous organs, they are tuned to different intensities of stimulus.

Pain spots occur, apparently, over the whole extent of the skin proper. Their distribution does not coincide with that either of the pressure or of the temperature spots. On the average, there



seem to be 100 to 200 pain spots to the sq. cm. With the exception of lips, teeth, and tip of tongue, the mouth cavity shows but little sensitivity to pain; a large area of each cheek is entirely free from pain spots. — The organs of pain are, perhaps, to be found in the free intraepithelial nerve-endings.

The sensation of pain is often blended with sensations of pressure and temperature. The following table gives the facts for the temperature senses:

	WARMTH ORGANS	COLD ORGANS	PAIN ORGANS
Bitter cold . . .	o	+	+
Cold, cool . . .	o	+	o
Lukewarm, warm . .	+	o	o
Hot . . . . .	+	+	o
Burning hot . . .	+	+	+

The sensation of prick or pain resembles the sensation of warmth in its slow and gradual rise to full intensity. It resembles those of pressure and cold in its persistence after the removal of stimulus; the prick aroused by the impact of the pin on the back of the hand may last, as positive after-image, for 10 sec. or more.

The pain sense does not appear to show the phenomenon of adaptation. If a pain spot is repeatedly stimulated, the sensation recurs, and presently the surrounding area becomes sore and irritable. It is true that, in everyday life, we learn to disregard pains of moderate intensity, such as muscular soreness or a continued slight rheumatism; but we ignore them, as we ignore distracting noises, because the attention is occupied with other topics, not because they fade out with time.

The dense distribution of the pain spots, the qualitative differentiation of their response to stimulus, and the long duration of

the after-image, account in general for the experiences of cutting, burning, scratching, abrading the skin. Whether they account in detail for all our experiences of cutaneous pain is still an open question. We said above that the granular sensation of pressure is often tinged with a faint ache. If, now, a fold of the skin — say, the fold between the fingers — is grasped firmly with a pair of forceps, the same dull ache appears. The pain in these cases is unlike any superficial pain, but like that of a severe acid burn. It may be, then, that there is another set of pain organs, deeper seated in the skin, whose characteristic sensation should be described as an ache. — The pains derived from subcutaneous tissues are discussed in § 56.

All pains at high intensities are extremely unpleasant or disagreeable. It is therefore only natural that, in ordinary speech, we refer to any very disagreeable experience as painful. But it must be distinctly understood that the sensations proceeding from the pain organs are not necessarily painful, in the sense that they are necessarily disturbing or unpleasant. The bright, itchy sensation and the sensation of prick occur as often as not in indifferent or pleasant complexes; it is only in the third stage, that of punctiform pain, that the sensation hurts. And even here, the pains aroused by minor injuries to the tissues seem in many cases to be insistent, interesting, rather than actually painful.

§ 42. **Theory of the Cutaneous Senses.** — We have seen that the end-organs of the pressure sense<sup>1</sup> are the hair-bulbs and the Meissner corpuscles. How are these organs affected by pressure stimuli? Under what precise conditions are they thrown into function?

If a point is set down upon the skin, the pressure is greatest directly beneath the point, and rapidly decreases

<sup>1</sup> The author knows of no skin-model that is satisfactory for psychological purposes. He uses the three Deyrolle models (*Coupe de la peau de l'intérieur de la main*, *Coupe de la peau montrant l'organisation d'un follicule pileux*, and *Coupe de l'extrémité d'un doigt*), upon which the end-organs mentioned in the text have been painted.

with increase of distance from it, — whether the distance be measured laterally, upon the surface of the skin, or vertically, into its substance. In other words, the point coincides with the maximum of what we may call a gradient of pressure. The gradient will be steep or gentle, according as the stimulus is strong or weak; it will take shape slowly or quickly, according as the point is applied gradually or with sudden impact.

Experiments show that the quick formation of such a pressure gradient is the adequate stimulus to the pressure organs. They show also that the gradient may be positive or negative; the pressure spots respond to pull as well as to pressure. It is not easy to say just what changes occur in the skin as the gradient is formed. There must, however, be a redistribution of the liquid contained in the tissues, and there may be local concentration; probably, therefore, the mechanical effect of pressure upon the surface of the skin is translated into a chemical action upon the end-organs.

Reference to the pressure gradient enables us to explain two observations which have aroused much discussion among psychologists. If the hand is dipped into water, or even into mercury, no pressure is sensed over the immersed area, but there is a distinct ring of pressure sensation at the place of emergence. The reason is, evidently, that here and here only does a noticeable pressure gradient occur. Again, if two objects of the same weight but of different size are laid successively upon the resting skin, the smaller appears the heavier. The reason is that the pressure gradient is steeper for the smaller, and more gentle for the larger object.

No theory of the temperature senses can as yet be offered; we have not even identified, with certainty, the terminal organs through which the sensations are aroused.

If, as seems probable, the organs of the pain sense are represented by the free nerve-endings of the epidermis, we have to account for the fact that the deeper-lying pressure spots are more readily stimulated by contact with material objects than the superficial pain spots. The reason lies in the nature of the cutaneous tissues. The epidermis is hard and inelastic, like a board; the cutis is soft and elastic, like sponge rubber. Hence, under ordinary circumstances, the stimulus is transmitted to the cutis, while the epidermis is not affected. When the epidermis is pierced by a fine point, or the dead cells of the outermost layer are cleared away and the tissue softened by soap and water, the superficial pain organs respond earlier than the organs of pressure.

§ 43. **Tickle and Itch.** — We described the sensation of contact as being somewhat ticklish, and the weak sensation of prick as being itchy. It would seem, then, that our everyday experiences of tickling and itching might be referred to a diffuse stimulation of the pressure spots and pain spots.

We get tickle, as a matter of fact, by brushing lightly, as with a feather, over a field of hairs. But we also get it, much more insistently, by brushing over a hairless surface, such as the red area of the lips, the palm of the hand, or the sole of the foot. The sense quality appears to be the same in the two cases. It is not quite easy to see how the pressure spots in the hairless regions can be stimulated by a contact which is too light to deform the skin: possibly, however, the application of the stimulus changes the pressure of blood in the superficial capillaries, and the nerve-endings are thus indirectly affected. The tickle that occurs when you are seized under the arms, or clutched on

the knee, appears deeper-seated than the tickle produced by brushing the skin.

Itching may be referred with some confidence to the organs of cutaneous pain. It is the result of certain skin-diseases, of superficial wounds and burns, of the bite of insects, etc.,—that is, of conditions by which the nerve-endings of the epidermis are directly affected.

It is often stated, as a paradox, that tickling makes us laugh, and is therefore pleasant, while it also makes us try to get away, and is therefore unpleasant. Such a statement is, however, far too simple for the facts. Tickling may be either pleasant or unpleasant, according to the region of the skin affected, the mode of application of stimulus, and the mood of the person tickled. Thus, it may be said in general that tickling on the sole of the foot or at the hairy orifices of nose and ear is distinctly unpleasant, while tickling on the palm of the hand or under the arm-pits is rather pleasant. Yet the flexing of the foot may change the unpleasant into a pleasant experience, and tickle on the palm may be almost unbearably disagreeable. The arousal of laughter, again, is extremely capricious. We can tickle ourselves, and get precisely the same sensations as when we are tickled by some one else; but we never make ourselves laugh. Nor can any rule be laid down as to the provocation of laughter by a certain form of stimulus, by stimulation of certain areas of the skin, etc. What holds of one person does not hold of another, or of the same person in a different mood. And the movements of escape are equally variable: a child may ask to be tickled to-day, and may beg not to be tickled to-morrow; a part of the body that is pleurably ticklish in one child may be unpleasantly ticklish in another, and so on.

All this variety of detail means that the tickle-stimulus does not act simply upon the sense-organ, as a colour-stimulus acts upon the eye, but that it serves as the trigger, so to speak, to release certain inherited mechanisms of our nervous system. These mechanisms are, however, themselves liable to modification or

arrest from higher nervous centres, so that they are not touched off inevitably or with uniform result. The reason for such a physiological arrangement can only be guessed at. It is significant that the areas which are especially ticklish are highly vulnerable: in nearly all of them some important structure, such as a large artery, is close to the surface; and where this is not the case, as in the sole and the palm, an injury, even if not serious, is seriously disabling to the organism. It may be, then, that tickling represents a very old form of race-play, the play of combat. The movements of attack and of defence are playful forms of fighting, and the laughter shows that the whole affair is a friendly game. This interpretation is, of course, speculative. Nevertheless, it accounts on the ground of utility for the persistence of the motor responses to tickling, while it also leaves room for their variety and uncertainty in our own case. On the whole, it probably comes as near the truth as, in the absence of exact data, we can expect any theory to bring us.

#### References for Further Reading

§§ 38-43. A. Goldscheider, *Gesammelte Abhandlungen*, i., 1898; C. S. Sherrington, *Cutaneous Sensations*, in E. A. Schäfer's *Text-book of Physiology*, ii., 1900, 920 ff.; J. Sully, *An Essay on Laughter*, 1902; M. von Frey, *Vorlesungen über Physiologie*, 1904, 308 ff.; T. Thunberg, *Druck-, Temperatur- und Schmerzempfindungen*, in Nagel's *Handbuch*, iii., 1905, 647 ff.; H. Head, W. H. R. Rivers and J. Sherren, *The Afferent Nervous System from a New Aspect*, in *Brain*, xxviii., 1905, 99; L. Török, *Ueber das Wesen der Juckempfindung*, in *Zeitschrift f. Psychologie*, xli., 1907, 23 ff.; E. Murray, *A Qualitative Analysis of Tickling: its Relation to Organic Sensation*, in *American Journal of Psychology*, xix., 1908, 289 ff.

## KINAESTHETIC SENSES

§ 44. **The Kinaesthetic Senses.**—In passing from the special senses to the group of organic sensations, we naturally turn first to the internal senses which are commonly included in the sense of touch. These senses have their organs in the motor apparatus of the body; they are set in function by bodily movements; they enable us, without help from the eye, to judge of the position and movement of our limbs. Hence they have been termed, collectively, the kinaesthetic senses.<sup>1</sup>

The nature of the tissues which make up the motor apparatus, and the distribution of sense-organs within them, may be understood from the following illustration. Think of two long bones, which form a ball and socket joint, and of a single muscle, which passes across the joint and is attached by its tendons to the shafts of the bones. The opposed surfaces of the joint are covered with cartilage. This thins out, at its margin, into a layer of vascular connective tissue, the periosteum, which extends over the entire shaft. The joint is enclosed in a capsule of ligament; the inner surface of the capsule and the inner faces of the articular cartilages are lined with synovial or lubricating membrane. The muscle is composed of bundles of muscle fibres; it is divided into compartments by fascial or sheathing tissue, and is invested by a thicker sheath of the same material. The tendons are strong, fibrous cords, directly continuous at the one end with the fascia of the muscle and at the other with the periosteum of the bone.

<sup>1</sup> The term was suggested by H. C. Bastian. See *The Brain as an Organ of Mind*, 1885, 543.



The muscles and tendons contain peculiar end-organs, known respectively as the muscle spindles and the spindles of Golgi. Pacinian corpuscles, or similar structures, have been found in fascial tissue, in ligament, in the synovial membrane, and in the periosteum of certain bones. Sensory nerve-endings occur also in the substance of the bony tissue. The sensitivity of the bone extends, apparently, up to the margin of the articular cartilages; whether it extends farther, so that the surface of the joint beneath the cartilage is sensitive, we do not know.

In everyday life, the sensations of the kinaesthetic senses occur only as factors in what we may call touch-blends. In all such experiences as lifting, holding, grasping, pushing, pulling, moving, handling, writing, playing a musical instrument, tying a knot, they are fused or blended with sensations from the skin. It is not surprising, then, that the skin should itself come to be looked upon as an active or motor organ, and should be credited with sense-qualities which are really derived from the deeper-lying tissues. The very fact that the motor apparatus is covered by the skin, that under normal conditions it cannot be separately stimulated, favours this confusion. Besides, the kinaesthetic sensations are, in general, very like the cutaneous; in one case, indeed, they seem to be indistinguishable from cutaneous pressure. For this reason, some psychologists still describe them as sensations of internal touch.

Nevertheless, the distinction between the sensitivity of the skin and that of the underlying tissues was drawn very early in psychology. Aristotle seems to have had an inkling of the difference, and it was clearly recognised in the sixteenth century.<sup>1</sup> Modern writers have usually

<sup>1</sup> Aristotle appears in general to bracket cutaneous and kinaesthetic sensations together, under the heading of touch. However, he says, in the *His-*

ascribed the deeper-seated sensations to the muscles, and the muscular sense has accordingly been added, as a sixth sense, to the list of sight, hearing, taste, smell and touch. We have learned, however, that this list is itself incomplete; and recent experiments, coupled with the study of pathological cases of partial anaesthesia, show that the muscles are but one, and that by no means the most important, of a number of sensitive tissues.

§ 45. **The Muscular Sense.** — To bring out the special quality of muscular sensation, we must find a method of stimulating the muscle alone, that is, independently of skin, tendon and joint. The best way is to lay out the arm on a support; to render the skin and the subcutaneous connective tissue anaesthetic by cocaine injection or ether spray; and then to press down upon the body of the muscle. The result is, first, a sensation which is described as dull, dead, diffuse; it is simple in nature, cannot be named, but suggests areal pressure upon the skin. With increasing intensity of stimulus, the sensation takes on a dragging character: sometimes there seems to be a hard, dead lump in the muscle, sometimes the muscle fibres seem to be ground or rolled against one another. The general impression is that of a tired, overworked limb. Finally, the dragging sensation becomes sore, achy, and the whole experience passes into dull pain.

The same series of sensations appears if a muscle is thrown into forced contraction by the electric current. Indeed, after a short

*tory of Animals*: "The sense of touch resides in the simple parts, as in the flesh; . . . the capacity of action resides in the compound parts, as . . . the power of locomotion in the feet or wings." For an historical discussion of the subject, see T. Reid's *Works*, ed. by W. Hamilton, ii., 1872, 867, note II.

practice in the laboratory, it is easy to identify the different stages, by introspection, in everyday life.

As the possible seat of muscular sensations, we have the fascial corpuscles and the muscle spindles. It is probable, from what we know of the joints (§ 47), that the corpuscles mediate a sort of pressure sensation. We may, then, provisionally, ascribe to them the dull, diffuse sensation, and to the spindles the dragging, sore, tired sensation that ultimately becomes pain.

§ 46. **The Tendinous Sense.** — In all cases of severe or prolonged muscular work, we get a sensation which cannot be identified with any one of those derived from muscle. Where we are ourselves active, as in wrestling, pushing, pulling, lifting, we term it effort or exertion; where we are passive, as in supporting a weight, or standing for a long time on one leg, we term it strain. The quality is the same throughout.

This sensation of strain appears to come from the tendons, and to have its organs in the spindles of Golgi. Like the dragging sensation from the muscles, it passes over, at high intensities of stimulus, into dull pain.

Tendinous tissue is, as we have said, directly continuous with the muscle fascia and with the periosteum. It is therefore impossible to isolate the tendon for separate stimulation. In seeking to discover the nature of tendinous sensation, we can only rule out the qualities that come from skin, muscle and joint, and note what is left. The remainder turns out to be the sensation of strain. Having reached this result, we find it confirmed by the intimate connection of strain with muscular fatigue and muscular pain, and by the tendency to localise these sensations together in the substance of the limb. —

There are, further, certain experiences which seem to depend upon the cooperation of end-organs in muscle and tendon. When we are feeling particularly well, we move lightly, springily,

jauntily; and if we try to analyse the feeling, we notice light, thrilling sensations, which appear to come from the skeletal muscles, and are most marked in the calves of the legs. Again, if we are feeling excited, and try to analyse that feeling, we soon come upon similar bright sensations, most marked in the thighs. Now corpuscles, of the same kind as those of the muscle fasciae and the capsules of the joints, are found in the sheaths and substance of the tendons, and sparsely in the substance of the muscles. They occur also in the sheaths of certain nerve-trunks, and near large vessels. In a word, they represent a widely distributed type of sense-organ. Since the sensations mentioned above are also distributed over a wide area, and since they closely resemble the sensations set up by movement in the joints, we may suppose that they are due to a weak stimulation of the corpuscles. Against this conclusion stands the dull, dead character of the sensation which is produced by pressure on the body of the muscle, and which we have ascribed to the corpuscles of the fasciae. It must, however, be remembered that the stimulus here employed is both unnatural and severe. As the pressure spots of the skin give first a bright sensation of contact, and then a sensation of more solid pressure, so may these corpuscular end-organs give first the light, thrilling experiences of health and excitement, and at higher intensities of stimulus something that is duller and harder.

§ 47. **The Articular Sense.** — If the hand is moved slowly to and fro at the wrist with fingers outspread, while the eyes remain closed, we have, besides the visual image of the movement, various sensations from the skin. There is probably a sense of coolness over the palm; and there are waves of diffused pressure, now across the knuckles, now down the front of the forefinger, now on the sides of the fingers, as the tension of the skin changes. Subcutaneous sensations from the body of the hand, if remarked at all, are exceedingly faint: there is no trace of

strain, and hardly a trace of muscular sensation. We notice, however, a rather massive complex of sensations in the wrist-joint, whose quality is not distinguishable from that of cutaneous pressure.

These sensations come, predominantly, from the end-organs of the articular ligaments. The general impression is the same as that produced by moving the finger over a greasy surface of indifferent temperature; or, better, by smearing a finger of the right hand with vaseline and turning it in the loosely closed left hand. Sensations of like quality are derived from the sensitive surfaces of the bones, around or beneath the articular cartilages. They may be brought out by pressing a finger strongly down into its socket, and in this position moving it back and forth.

The corpuscles are distributed most thickly on the flexor side of the articular capsule, and it is easy to see that they must be stimulated by the tensions and compressions of the tissue as the limb is moved. The corpuscles of the synovial membrane and of the ligaments that, in some joints, run between the articular surfaces may be stimulated either by movement or, like the surfaces of the bones, by pressure and counterpressure within the joint itself. —

The last few sections have raised a question which recurs throughout the study of organic sensation: the question whether we may assume that every sensory end-organ is an organ of sense. It seems natural to reply in the affirmative. If the hair-bulbs, and Meissner's corpuscles, and the free nerve-endings of the epidermis, and such and such other structures furnish sensations, why not all the rest of them? Nevertheless, a decision is not easy. In the skin, for instance, there are many such organs — Ruffini's plumes, Tomsa's knots, Merkel's cells — which cannot with certainty, even with probability, be brought into connection with sensations. As histological research advances, more and more of these structures are brought to light. Either they are, in large

measure, mere reflex mechanisms, or they are sense-organs which, despite differences of form, yield the same quality of sensation. The second of these hypotheses is, perhaps, the more probable. Differences of form may be attributable to local differences of nutrition and of the conditions of development at large ; indeed, several of the corpuscles figured by histologists seem to be related as terms of a single developmental process.

§ 48. **Movement and Position, Resistance and Weight.**— We are able, with closed eyes, to tell pretty accurately in which direction a limb moves and how far it travels. We are also able, as a rule, to describe the position of an unmoved limb. These perceptions of movement and position are based upon the articular sensations discussed in the preceding section.

It seems clear, on general principles, that the perception of movement cannot come by way of muscle and tendon. For movements of equal range and of like direction may be made with the limb bent in or stretched out, heavily weighted or held free : that is to say, similar movements may involve very different degrees of muscular and tendinous sensation. It is hardly possible that a reliable set of perceptions of movement could be built upon so instable a foundation. Moreover, experiment shows that we estimate passive movements as correctly as active ; it makes no difference whether the arm, for instance, is laid on a rest and moved by someone else or whether we hold it out and make the movement for ourselves. The perception of movement is, then, as a matter of fact, independent of changes in muscle and tendon.

There is also positive evidence to connect the perception of movement with the joints. In the first place, skin, muscle and joint may be rendered partially anaesthetic by faradisation, that is, by the repeated passage of electrical shocks through them. If, now, the skin and muscles are thus treated, the perception of movement is not affected ; if, however, the joints are anaesthetised, it is very considerably impaired. Secondly, there are diseases



which bring with them anaesthesia of the skin, or of skin and muscles together, or of the whole surface and substance of a limb. In the former, the perceptions of movement and position are normal; where the muscles are involved, they are not inadequate; but where the joints are also insensitive, the patients can neither adjust their movements nor judge of the position of the diseased limb without the aid of sight.

It may be objected to this view that we are aware of certain movements — movements of tongue, lips, eyeballs — in which the joints are not concerned. That is true. It must, however, be remembered that tongue and lips play against fixed structures, the roof of the mouth and the teeth; and it is, in fact, mainly by reference to these that their movements are estimated. One has only to hold the tongue free in the mouth cavity, and to watch its movements in a mirror, to be convinced that an organ which has only skin and muscle to rely upon is exceedingly obtuse as regards the perception of movement. With the eye things are different. The eyeball turns on the fatty cushion of the orbit very much as the ball of a joint turns in its socket. We thus get a true perception of movement of the eyes, although the sensations are dulled and weakened by the yielding nature of the tissues. —

We have spoken throughout of the perception of movement: there is no such thing as a specific movement sensation. What happens is that a complex of articular sensations becomes associated, with constant repetition, to a visual perception of a movement. The association is, in course of time, so firmly established that the occurrence of the articular complex calls up, even with closed eyes, a visual idea of the displacement of the limb. Position is perceived in the same way. When a limb comes to rest, there is a certain final distribution of tensions and compressions in the ligaments of the joints, which gives rise to a complex of sensations. So long as these persist, we can call up a visual idea of the position of the limb. When they fade out, by adaptation, we lose the visual idea along with them, and can recover the perception of position only by making movements which bring the articular end-organs into renewed function. We have all had the experience, on waking from a sound sleep, of a blank loss of arm



or leg : for a moment, we cannot imagine where the thing is. A slight shift of position puts us to rights again.

When we lift a weight, we are working against the force of gravitation; when we overcome a resistance, we are working against mechanical forces in some other direction. The perceptions of weight and resistance seem to be of the same order, psychologically, as their objects are of the same order physically. Their organs are, in the first instance, the sensitive surfaces of the joints. When strain or exertion is involved, the spindles of the tendons also come into play.

The perception of weight may be either passive or active. If the arm is laid out upon a table, and a heavy object placed upon the skin, we have the passive perception: the organs affected are the pressure spots of the skin, and the Pacinian corpuscles of the subcutaneous connective tissue and the muscle fasciae. Under these circumstances, our discrimination of weight is inaccurate; it corresponds to the perception of movement by tongue or lips. When the weight is lifted, and the perception thus becomes active, discrimination is much more delicate; it corresponds to the articular perception of movement.

Some psychologists separate the perception of weight from that of resistance, and refer the former to the tendons and the latter alone to the articular surfaces. And indeed it seems natural, at first thought, to say that the pull of a weight must draw the surfaces of the joint apart, while the resistance of an inert body must jam them together. Really, however, the very fact that the arm is braced and set for lifting means that it is strongly bound at the joints; and the heavier the weight to be raised, the greater is the articular pressure. Moreover, it makes little difference in the perception of lifted weights whether the arm is flexed or extended, whether the hand grasps the object loosely or tightly; so that the perception is, at least in some degree, independent of the state of the tendons.

Again, some psychologists hold that the sensitive surfaces of the bones play a large part in the perception of movement. The surfaces must, of course, rub against each other as the limb is moved; and we know that patients who suffer from anaesthesia of skin and muscles perceive movement and position more accurately when the joints are pressed together than when they are pulled apart. On the other hand, the rubbing can be but light in the case of passive movements, where we are relieved of the weight of the limb. And it is possible, in the pathological conditions, that the sensations from the bones serve, by adding to the sum of articular sensation in general, simply to call the patients' attention to the diseased limb, without contributing directly to their perception of its movement. The strongest bit of negative evidence lies, however, in the fact that we may get the same perception of movement with very different accompaniments of resistance. —

Here as before it is important to remember that we are dealing not with sensations but with perceptions. In movement, we have a complex of sensations from the joint capsule, along with varying sensations from skin, muscle, tendon and articular surface. In weight and resistance, we have a complex of sensations from the articular surfaces, coloured at high intensities of stimulus by tendinous strain, along with varying sensations from skin, muscle and joint capsule. There is no specific sensation of weight or of resistance.

§ 49. **The Alleged Sensation of Innervation.** — We have so far taken it for granted that sensations are due to the action of stimuli upon a sense-organ. Light falls on the eye, or a contraction of the muscle fibres squeezes the muscle spindles; the excitation thus started is carried, by afferent sensory nerves, to the brain; and we get the sensation of colour or of fatigue. The course of the nerve process which arouses sensation is always from without inwards, from periphery to centre.

There is, however, one case — that of the sensation of effort or exertion — in which this view has been challenged. We have ascribed the sensation to the Golgi spindles (§ 46), and have thus put it upon the same plane with all other sensations. Some psychologists believe, on the contrary, that it is an outgoing sensation, due to the discharge of motor excitations from brain to muscle. Its nerve process would then run from within outwards, from centre to periphery.

The arguments are drawn, in the main, from pathology. A patient who cannot move a leg, or who cannot turn his right eye outwards, may nevertheless believe that he has made these movements; he will assure his physician that he feels the weight of the moved limb, or the turn of the eyeball in the orbit. Since no movement is made, these sensations must, apparently, come from the centre, must accompany the outgoing current of innervation.

We notice, however, in observing such patients, that the effort to move the diseased leg always means a shift of the hips, and various jerks and twitches in the sound leg; and that the effort to move the right eye always means actual movement of the left. Here, then, are sources of kinaesthetic sensation which might easily give the illusion of movement in the unmoved part. Besides, there are pathological facts to be quoted on the other side. In certain diseases, a patient may make quite extensive movements of the limbs, without being aware of the fact; indeed, he is surprised, when his glance falls upon arm or leg, to find that it has changed its position. Since these movements are made, they must have been innervated; since they are made unconsciously, the innervation cannot have aroused any sensation of effort.

The following experiment tells very strongly against the existence of the innervation sensation. If two objects of the same weight but of different size are lifted successively in the closed hand, or even if they are lifted by a string attached to the finger, the smaller appears the heavier. The observer may have seen them weighed, and may be convinced that the weights are physically equal: nevertheless, the illusion persists. If, now, the judgment of weight depended upon a sensation of innervation, this result would be impossible: the observer, knowing that the same amount of energy is required to raise both objects, would innervate his muscles to the same degree.

We explained a similar illusion of the resting skin (§ 42) by the difference in the slope of the pressure gradient. This factor is here replaced by visual association. In the vast majority of cases, the larger of two like objects is also the heavier. Hence we have learned to interpret size as weight; when we see a large thing, we unconsciously innervate the muscles for a heavy thing. The association holds, in spite of our knowledge that the weights are equal: we lift the larger object as if it were heavy, the smaller as if it were light. The former then flies up, giving us the kinaesthetic sensations that light things arouse, and we judge it to be lighter than its companion.

§ 50. **Some Touch-blends.** — We are now able to analyse the touch-blends mentioned in § 39. The difference between hard and soft, for instance, is mainly a difference in degree of resistance offered to the hand; and this means a difference in the degree of pressure exerted by the one articular surface upon the other. The distinction thus belongs to the joints rather than to the skin. Again, the difference between smooth and rough is a difference, first, between continuous and interrupted movement, and secondly between uniform and variable stimulation of the pressure spots of the skin. The distinction thus belongs to joints and skin together.

Sharp and blunt differ, primarily, as pain and pressure: a thing is sharp if it pricks or cuts, blunt if it sets up diffuse pressure sensations. Here, however, as in all the touch-blends, visual association plays a very large part.

Wetness is a complex of pressure and temperature. It is possible, under experimental conditions, to evoke the perception of wetness from perfectly dry things, — flour, lycopodium powder, cotton wool, discs of metal; and it is possible, on the other hand, to wet the skin with water and to evoke the perception of a dry pressure or a dry temperature. Not the moistening of the skin, but the fitting distribution of pressure and temperature sensations, gives rise to the perception of wetness. Other modes of distribution of the same sensations produce the perception of dryness.

Clamminess is a mixture of cold and soft: the cold sensations and the pressure elements in the softness must be so distributed as to give the perception of moisture. The clammy feel of a wet cloth may be got by laying the finger on a loosely stretched rubber membrane, and sending a puff of cold air over it at the moment of contact. Oiliness is probably due to a certain combination of smoothness and resistance; movement seems to be necessary to its perception. Clinging, sticky feels may be obtained from dry cotton wool.

#### References for Further Reading

§§ 44-50. A. Goldscheider, *Gesammelte Abhandlungen*, ii., 1898; V. Henri, *Revue générale sur le sens musculaire*, in *L'Année psychologique*, 5me année, 1899, 399; C. S. Sherrington, *The Muscular Sense*, in Schäfer's *Text-book*, ii., 1900, 1002 ff.; I. M. Bentley, *The Synthetic Experiment*, in *American Journal of Psychology*, xi., 1900, 414 ff.; R. S. Woodworth, *Le Mouvement*, 1903; W. Nagel, *Die Lage-, Bewegungs- und Widerstandsempfindungen*, in Nagel's *Handbuch*, iii., 1905, 735 ff.

§ 51. **The Kinaesthetic Organs of the Internal Ear.** — We have found, in the capsules of the joints, organs which receive their stimulation from movement of the limbs, and which give us the perceptions of movement and position of these members. We have now to consider certain structures of the internal ear, which represent kinaesthetic organs of a different kind. They are stimulated mechanically, by the acceleration of a mass-movement through gravitation, inertia or centrifugal force, and they give us the perceptions of movement and position of the head and, perhaps, of the whole body. They are known as the cristae ampullares of the semicircular canals, and the maculae acusticae of the vestibule.

In § 28 we dealt with the cochlea of the internal ear, the part of the membranous labyrinth which forms the end-organ of the cochlear nerve and furnishes sensations of hearing. We are now to discuss the function of the remaining portion, the vestibule and the semicircular canals, which together form the end-organ of the vestibular nerve.<sup>1</sup> There are five cell-groups, in each ear, to which the fibres of this nerve are distributed: the maculae of the utricle and saccule, the two divisions of the vestibule; and the cristae in the ampullar enlargements of the three semicircular canals. Maculae and cristae are all of the same general type: there is a local thickening of the membranous wall, upon which rests a little field of hair-cells. In the maculae, however, the hairs support a mass of tiny crystals of carbonate of lime, the otolith; in the cristae, they project freely, like a camel's-hair brush, into the ampullar cavities. The otoliths are enclosed in a homogeneous, viscous substance, which also interpenetrates and surrounds the ampullar hairs. The mass which is moved in the maculae is, therefore, the otolith; in the cristae it is the cemented brush-like structure, which has been termed the cupula. —

<sup>1</sup> In addition to the models of the internal ear mentioned on p. 109, Exner's Bogengangmodell (shown in Fig. 24, p. 177) and Otolithenmodell will be found useful for demonstration.



The study of the semicircular canals and the vestibule presents a curious difficulty to psychology, a difficulty the reverse of that which we have just met in our discussion of the sensitivity of muscle, tendon and joint. There, we had a tangled complex of sensations, and the problem was to distribute them among the available end-organs. Here, we have highly developed end-organs, but no very obvious group of sensations to refer to them. Moreover, there can be no doubt that the functions of the vestibular nerve are, in large measure, reflex: by virtue of its cerebellar connections it plays a large part in the regulation of what one may call the tone of the muscular system; the impulses normally proceeding from it keep the muscles trim and braced, while the cutting off of these impulses has an atonic effect similar to that produced by section of the dorsal roots of the myel. Under these circumstances, it is not surprising that different investigators should take very different views of the kinaesthetic importance of cristae and maculae. The following sections, however, represent the general trend of current psychological opinion.

§ 52. **The Ampullar Sense.**—If you turn round rapidly upon the heels several times in succession, and then come to rest with closed eyes, you have a sensation which can only be described as a swimming in the head. Its apparent direction is opposed to the direction of the actual movement, so that it wears the appearance of a negative after-image. Having once noticed it, you are afterwards able to notice, as you begin to turn, a swimming whose direction is the same as that of the movement of rotation. The sensation seems to circle through the head, and its plane changes with change of the head's position. If, for instance, you turn round with the head bent forwards on the chest, and suddenly raise it to the normal attitude after you have stood still, the plane of the swimming changes, as suddenly, from horizontal to transverse vertical; if you



turn with the head inclined on the shoulder, and raise it afterwards in the same way, the plane changes from horizontal to sagittal.

This swimming sensation, which with practice may be observed to follow a quick movement of the head in any direction, comes from the cristae of the semicircular canals. At high intensities, it passes into dizziness or vertigo.

It is significant that we find the canals fully formed, and conjoined with a merely rudimentary cochlea, in animals, such as birds and fishes, which have to balance in the surrounding medium. Their size and accessibility, in these lower vertebrates, makes experiment easy: the canals may be severed, plugged, or extirpated without further injury to the organism. If, now, a single canal is cut, say, in a pigeon, we note, as the result of the operation, a general slackening of the whole muscular system, and also a disturbance of movement in the plane of the severed canal. On the one hand, the bird seems weakened: its flight is feeble, its legs bend inwards; on the other, it is subject to certain forced movements. If, for instance, the right horizontal canal is cut, the pigeon keeps up a pendular motion of the head sidewise, to the right and back again; it also tends, in walking, to bend to the right and so to circle round and round, instead of moving straight forward. These symptoms vary with the extent and the standing of the injury. Where the lesion is one-sided, there may presently be complete recovery; if both sets of canals are extirpated, the muscular weakness may end in general muscular atrophy, and all coordinated movements are thrown into confusion.

It is clear, then, that the canals constitute an organ which serves to regulate the tone of the muscular system. But it seems clear, also, that they stand in a special relation to movements of the head. Injury done them not only cuts off the tonic impulses, but in addition gives rise to abnormal impulses which arouse the abnormal movements. This dynamic function might, like the tonic, be reflex. Probably, however, it is attended by sensation, the quality of which is lost to ordinary observation in the complex

of cutaneous and kinaesthetic sensations which we have described in previous sections.

The evidence for sensation comes partly from experiments made upon the normal human subject, and partly from pathology. Experiments upon rotation, carried out under strict conditions, reveal the swimming and dizziness of which we have spoken. Similar sensations are evoked by syringing the ear, or passing an electric current through it. Further, it is found that about half of the deaf-mutes in our large institutions cannot be made dizzy by rotation; they do not stagger when the movement ceases, nor do they show the compensatory twitching of the eyes which is normally a symptom of dizziness. Now, autopsy proves that in about 50 per cent. of deaf-mute ears there is lesion or degeneration, not of the cochlea alone, but of the whole internal ear. This correspondence furnishes a strong argument for referring the sensation of dizziness to the canals.

§ 53. **Theory of the Ampullar Sense.** — The three semi-circular canals of each ear are set, approximately, in the three dimensions of space. They are also set symmetrically in the two ears: the horizontal canals in the same horizontal plane, and the posterior of the one side and the anterior of the other side in parallel planes. It is thus clear that any movement of the head, whatever its direction, must affect the canals. If it is made in a plane which coincides with the plane of a canal, then that canal alone will be stimulated; otherwise, two or more canals will be involved, in different degrees, on the principle of the parallelogram of forces.

Suppose, then, that we are subjected to a rotary motion in the horizontal plane. When the turning begins, the water in the horizontal canal lags behind the containing tube; the back thrust of the water bends the cupula; and the nerves of the crista are stimulated. We have the swimming sensation. As the turning

continues, the water takes up the motion of the canal, and the cupula recovers its equilibrium. When we stop, the water in the tube shoots forward, bending the cupula in the opposite direction; and we have the reversed swimming sensation, which continues until the ampullar organ comes to rest in its normal position.

Precisely the same thing happens if we turn round voluntarily on the heels, and precisely the same sort of stimulation is set up, in the other canals, by movements in other planes. —

The quality of the ampullar sensation, at low intensities, is most like that of a diffused pressure. The direction of the swimming is not directly sensed, but depends upon association.

Dizziness usually occurs in a very complicated setting. When we have turned upon the heels, and have come to a sudden stop, the kinaesthetic sensations from the limbs are so disposed as to give the perception of a certain position. On the other hand, the swimming in the head, and the arrest of the soft viscera by the body wall, give the perception of a movement in the opposite direction. Further, if the eyes are opened, the objects about us seem to be revolving in the same direction as that of our original movement. Here, then, is a conflict, so to say, of three different perceptions: the limbs are at rest, the body is moving one way, and the outside world is moving another way. Oftentimes, to make things still worse, nausea is added.

Under these conditions, introspection is very difficult. Some psychologists deny the sensory character of dizziness altogether, and regard it as the resultant of the conflicting perceptions. Since, however, it may be set up by such local stimuli as the passage of

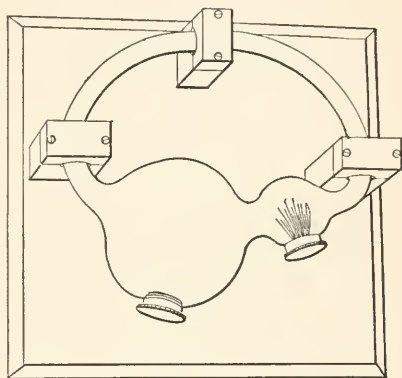

FIG. 24. Exner's Model of a Semicircular Canal.

an electric current through the ear, it appears to be referable to the ampullar organs. Moreover, there can be no doubt that the sensation in the head, as we turn it sharply to one side or start to turn round, is from the first swimmy, faintly dizzy, so that dizziness would seem to be the quality natural to it at high intensities.

§ 54. **The Vestibular Sense.**—The sensory function of the maculae is still somewhat problematical. It appears, however, that they play a part in our perceptions of the position of the body as a whole, and possibly of rectilinear movements of the body in space, more especially when these perceptions refer to the vertical dimension. —

We have noticed that the people who ride on merry-go-rounds at fairs lean inwards, as the speed of rotation increases; they shift their balance, to avoid flying off at a tangent. This is natural enough. What is curious is that, provided the eyes are closed, the riders think that they are sitting uniformly upright. If they are asked to hold a stick before them, vertically, as they revolve, they hold it at a slant; their perception of the vertical has changed. Again, we have noticed that, when the body is immersed in water, as in diving or in swimming beneath the surface, there is never any doubt as to which direction is up and which down. No one with normal sense-organs has ever been drowned by swimming to the bottom when he intended to come to the top of the water.

These perceptions are noteworthy when we compare them with the behaviour of the deaf-mutes who lack the sensation of dizziness. If such persons are placed upon a merry-go-round, they do not adjust themselves to a new vertical. They sit bolt upright, and hold the stick to the true vertical; they must be tied, or they are thrown off by centrifugal force. And it is dangerous for them to bathe

in deep water, even if they know how to swim, because, once they are immersed, they lose the perceptions of up and down, and may drown from sheer confusion of directions.

It seems, then, that we must have some source of perception which the deaf-mutes are without; and it is natural to look for it in the vestibular organs. Many psychologists believe that the maculae furnish sensations of pressure, which, under favourable conditions, may be separately distinguished by introspection.—

Most of us have noticed, again, as we lay in a sleeping car or were carried in an express lift to the top of a high building, that there were parts of the journey during which the perception of movement altogether disappeared. The eyes must, of course, be closed; there must be no draught of air to suggest that we are moving; and the motion itself must be smooth and uninterrupted. Under these conditions, a movement of the body forwards or backwards, up or down, is not perceived, so long as its rate remains the same. Let the rate change, however: let the car slow or quicken its speed: and we are at once aware of our passage through space.

Some psychologists believe that whenever there is acceleration, positive or negative, of the rate at which the body is travelling, the maculae are brought into action; while, so long as the rate is uniform, they adapt themselves to it, as the ampullar organs adapt themselves to uniform movement of rotation. If the movement is in the horizontal plane, forward, backward or sidewise, the vestibular sensations are ordinarily swamped in the mass of sensations from skin, muscle, tendon and joint. If, on the other hand, it is in the vertical plane,—as in going up or down in a

lift, tobogganing, dropping off a high place, swinging,—the sensations appear as a compression or lightness in the head. Like the ampullar sensations, they are often clearest in the form of negative after-images: when a rising lift suddenly comes to a standstill, we have a distinct feeling of squeeze in the region of the ears.

§ 55. **Theory of the Vestibular Sense.**—The maculae function in much the same way as the cristae. The otoliths which are suspended above the fields of hair-cells correspond to the water in the canals; they lag behind, as the supporting structure moves away, and they overshoot or press down upon their support when the movement is arrested. The two maculae of each ear are so situated that the lines of displacement of the otoliths are at right angles to each other; the one moves in a horizontal plane, which slopes at an angle of some  $45^{\circ}$  from before backward, and the other in a sagittal plane, which slopes at the same angle from behind forward. They are thus affected, on the principle of the parallelogram of forces, by movements in any spatial dimension.

Applied to the changed perception of the vertical on the merry-go-round, this theory means that the centrifugal force shifts the otoliths outwards; they glide into the position that they would naturally assume if one were really leaning outwards with the body at rest. The true vertical thus seems to slant out, and an effort to restore it means a bend inwards. A like explanation holds of the perception of direction under water; the pressure or pull of the otoliths tells us whether we are head-up or head-down. Destruction or atrophy of the organs would then lead to those insufficiencies of perception which we note in the deaf-mutes.

Whether we may appeal to displacement of the otoliths for the perception of acceleration of movement in the horizontal



plane depends upon the degree of inertia which they possess. Since this is not known, any hypothesis would be merely guess-work. There is, however, no introspective evidence of their function, as there seems to be in the case of rectilinear vertical movements of the body. —

Otolith organs have a very wide range in the animal kingdom, a range that extends from the jelly-fish to man. Their functions appear to be, from the first, tonic and static. It has been found possible, for instance, to replace the otolith of a crustacean, which sheds the contents of the otocyst at the same time that it sheds the skin, by a mass of fine iron-filings. When the artificial otolith is approached by an electromagnet, and the circuit closed, the animal assumes a peculiar position which is directly due to the stimulation of the organ. On the other hand, the otolith sac is the precursor of the organ of hearing, and this fact has been made much of in theories of its function. It has been suggested, for instance, that the maculae of our own ears give the sensations of noise, and possibly of shrill, chirping tones, and that the cristae give us the perception of the direction from which sounds come. There is no evidence for either view. Again, it has been found that the hairs which support the otolith are, at least in some forms, selective : if tones are sounded in their neighbourhood, certain hairs remain passive, while others — varying with variation of the stimulus — are thrown into violent vibration. In the same way, the hairs of the feathered antennae of the male mosquito vibrate selectively to notes which correspond in pitch to the hum of the female insect. It is tempting, in such cases, to regard the vibratile organ as auditory, and to conclude that the stridulating, rasping and tapping sounds of the invertebrates are heard by others of their kind as they are by ourselves. It must, however, be remembered that sympathetic vibration is a purely mechanical matter : the excitation set up by the moving hairs might release a reflex, or might be sensed as jar or quiver. Indeed, the close relation of the otolith organ to the organ of touch makes it probable that their sensations would be closely alike. Even the fish, in which the membranous labyrinth has begun to divide into a vestibular and a cochlear portion, do not appear to possess sensations of



hearing, while they are extremely sensitive to jar of the water in which they swim. On the whole, then, and with the reserve which is due to the obscurity of the subject, we may say that true hearing probably appears at a point fairly high up in the vertebrate series.

#### References for Further Reading

§§ 51-55. J. G. McKendrick. *The Internal Ear*, in Schäfer's *Text-book*, 1900. 1166 ff., 1194 ff.; W. Nagel, in Nagel's *Handbuch*, iii., 1905. 778 ff.; W. Wundt. *Physiologische Psychologie*, i., 1908. 440 ff.; ii., 1902. 475 ff. J. Lubbock. *On the Senses, Instincts and Intelligence of Animals*, 1889, chs. iv., v.; R. M. Yerkes, *The Dancing Mouse*, 1907, ch. v.; M. F. Washburn. *The Animal Mind*, 1908, ch. vi.

## OTHER ORGANIC SENSATIONS

§ 56. **The Sensitivity of the Abdominal Organs.** — We may group together, under the name of visceral sensations, all the sensations, except those of sex, which are derived from the internal organs of the body below the diaphragm. The evidence for the nature and origin of these sensations, and for the part that they play in the make-up of consciousness, comes from various sources, surgical, physiological, pathological, psychological. It is not all of the same tenor, and no single line is at all complete.

Let us take, first, the testimony of the surgeon. Operations upon the abdominal organs are now fairly common, and in many cases the anaesthetic employed affects only the outer skin and the underlying connective tissue. Under these circumstances, it has been found that stomach, intestine, liver, gall bladder, kidney, — with the investing and interstitial tissues, — as well as the rectal mucous membrane, the anterior wall of the vagina, the uterus, the ovaries, the Fallopian tubes with the adjacent portions of the broad ligaments, and probably the part of the testes that is covered by serous membrane, are one and all insensitive. The organs may be pinched, stretched, cut, pricked, burned, cooled, and the patient knows nothing about it. On the other hand, the external or parietal peritoneum, which lines the abdominal and pelvic walls, the muscular and serous layers of the diaphragm, and the tunica vaginalis, are extremely sensitive: the first and third, apparently,

to pain alone, the second to pressure and pain. From the surgical point of view, then, the whole mass of visceral sensations must be referred to these three tissues. The sense of satiety, of a full stomach, would come from an upward pressure against the diaphragm, colic pains would be due to the pressure or pull of the distended intestine upon the peritoneum, and so on.

On the whole, the results of direct physiological experiment support this conclusion. Nevertheless, physiology seems to take away with the one hand only to give with the other. We learn, for instance, that there are enough sensory mechanisms in the abdominal cavity to furnish any number of sensations. We are reminded, also, of the difference between adequate and inadequate stimuli. The inroads of a surgical operation are not natural or normal to the organism; and it is entirely possible, from the physiological standpoint, that sensations may be aroused, by natural processes, in organs which fail to respond to external attack. In particular, we are confronted with the law of reflex pain. Wherever two regions, of low and high sensitivity respectively, stand in close nervous connection, an injury done to the former is referred, as sensation of pain, to the latter. Now viscera and skin are thus connected. Hence a visceral disturbance might be sensed, locally, as mere vague oppression, while the related area of the skin was the seat of sharp, cutting pain. In other words, the skin may steal from the viscera as taste steals from smell.

If we turn to pathology, we find the facts as definite as those offered by surgery, but of an opposite character. There are cases of visceral anaesthesia, in which the patients cannot tell whether they have eaten enough, but

must measure out the amount of their food ; in which they do not feel the need of evacuating the bladder and bowels, etc. Now in these cases there is loss, not only of such things as appetite, nausea, repugnance to food, the sense of renewed vigour after sleep, but also of feeling and of perception. Feeling may be lost entirely ; the patients are apathetic, incapable of most if not of all the emotions ; the agreeable and the disagreeable aspects of experience disappear together. We return to these phenomena in § 74. More to the present point is the loss of perception. The patients have no knowledge of the flight of time ; in the daytime they depend solely upon the clock, and on waking in the morning they are not aware that they have slept. Plainly, then, if we may trust pathology, visceral sensations exist in some variety, and serve as the raw material of certain complex perceptual processes.

All these differences may be reconciled, though as yet only in a broad and general way, by an appeal to psychology. The most obvious thing about visceral sensations is their periodical recurrence. For the greater part of the day we know nothing whatever, if we are in good health, of the state of the abdominal organs ; introspection of visceral sensation is impossible, because there is no sensation to introspect. But for short times, at fairly definite intervals, they loom large in consciousness ; either as hunger and repletion, thirst and its satisfaction, or as the characteristic feels that precede, accompany and follow urination and defaecation. It is, evidently, this character of recurrence that fits them for the part they play in perception. It proves, further, that they are aroused only under certain peculiar circumstances, on the occurrence of certain changes in their organs. Since surgical operations

do not reproduce these circumstances or bring about these changes, it is not surprising that the organs should show themselves insensitive to knife and cautery. The negative results are facts, but from the standpoint of psychology they are irrelevant facts. The same thing holds of the results of physiological experiment. The physiologist asserts that the stomach is insensitive to temperature; if we drink hot or ice-cold water, we have at most a dull heaviness in the stomach, while the warmth or cold is referred by introspection to the body wall. But there may be a law of reflex temperature sensation, as there is a law of reflex pain. And in any case, we have no proof, in such results, that the stomach is altogether insensitive, when stimulated adequately, in the appropriate way.

In general, then, we may say that the external peritoneum is probably responsible for colic pains; that the diaphragm furnishes both muscular sensation and pain; and that there are other sensations, peculiar to the alimentary canal, which are aroused by special stimuli at recurring intervals of time. We have now to examine these latter in more detail.

We distinguish, in ordinary speech, many different sorts of pain: we speak of head-ache, tooth-ache, stomach-ache, ear-ache; of rheumatic, sciatic, gouty, neuralgic, anginal, labour pains; and, more generally, of dull, acute, fine, massive, throbbing, lancing, gnawing, cutting, aching, boring, shooting, stabbing, rending, chafing, smarting, burning, scalding, racking pains. It is a disputed question whether pain, as used in these phrases, is like colour a general name for a number of sensible qualities, or like cold the name of a single quality. On the whole, it seems necessary to distinguish two ultimate pain sensations, a fine bright and a heavy dull pain (§ 41); all other differences, however, appear to be reducible to differences of intensity, of diffusion, and of duration or periodicity.

Thus, a stabbing pain is a pain of limited area, definitely localised, which suddenly attains a high degree of intensity; a boring pain oscillates between certain limits of intensity; a racking pain swells gradually to its maximum, and then sinks again; and so on.

§ 57. **The Sensations of the Digestive and Urinary Systems** — Thirst is localised in the soft palate, and appears as a diffuse pressure or as a blend of pressure and warmth, — dryness and feverishness. It may be quenched, for a time, by painting the soft palate with acid, or by rinsing the mouth with water, or even by wetting the skin of face and neck: that is to say, by stimuli which cool and moisten the tissues, and start the salivary glands to action. It soon recurs, however, as what Helmholtz called a general feel of the lack of water in the body, though it is still referred predominantly to the soft palate; in this form, it may be assuaged by the injection of fluid into a vein. We may, perhaps, suppose that a deficiency of lymph in the lymph-spaces of the mucosa of the soft palate brings about a relaxation of the membrane, which serves to stimulate Pacinian or kindred organs. Since the alimentary canal is the normal channel by which the body is supplied with water, it is natural that a regulative organ of especial sensitiveness should be placed at its entrance.

Next in order, if we travel from above downwards, is the sensation of hard pressure that results from the hasty swallowing of too large a morsel or too large a gulp of liquid. Unlike most of the alimentary sensations, this pressure is localised towards the back. Its downward course can be followed by introspection. It often has upon it a suggestion of nausea, and undoubtedly comes from the oesophagus; but whether from the free nerve-endings of the mucosa or from the layers of striped muscle, we do not know.

Nausea itself is usually preceded and accompanied by cold sweat and copious salivation. Besides the sensations thus arising, it is sometimes complicated by a bitter taste at the back of the mouth, by sensations of taste and smell from contents returned by the stomach, and by dizziness. Intrinsically, it appears as a sensation of pressure-like quality, localised at the lower end of the oesophagus, and probably due to muscular constriction. — The act of vomiting introduces sensations from the muscles of the abdominal wall and the diaphragm, and from the pharynx, all of familiar quality.

Hunger, like nausea, is a complex experience. It is characterised by a dull ache, extending throughout the lower jaw; by pressure in the pharynx; and by the sensations accompanying salivation. Its specific sensation is a dull pressure in the stomach; this rises, through a gnawing soreness, to positive aching pain. The reference of hunger to the stomach is as unhesitating as that of thirst to the soft palate, and its localisation may be made definite by palpation of the skin. The sensation may, perhaps, be ascribed to tension of the stomach, caused by the engorgement of the mucosa with the digestive granules developed in the cells. — The sense of repletion, and the oppression of a too hearty meal, are also referred to the stomach, and may be definitely localised by palpation. We can only guess that they are due to a tension of the walls of the stomach, possibly complicated, in the case of overloading, by pressure upon the abdominal wall and the diaphragm.

The intestinal tract from stomach to rectum is usually free from sensation, with the exception of occasional colic pain. Persons with weak digestion, however, report that they generally find, after eating, stationary or travelling



pressure sensations in this region. The sensations are referred to the front of the body, and may be localised by palpation.

The sensations which appear before, during, and after defaecation are those of pressure and dull pain. In urination, the sensation of warmth is added. The pressure in both cases is somewhat sore, tinged with an ache; it is not unlike the sore muscular sensation (§ 45). The relief that follows evacuation is partly a negative matter; we are freed from a mass of insistent sensation and can turn our attention elsewhere. Oftentimes, however, we get a positive sense of lightness, akin to the bright diffused pressures of health and excitement (§ 46) and perhaps referable to the same organs.

It is tempting to regard the specific sensations of thirst, nausea, hunger, etc., as novel qualities. Closely analysed, however, all the experiences above described seem to reduce to two familiar continua: the light, thrilling sensations which pass into dull, hard pressure, and the sore, achy sensations which pass into dull pain. It would be overhasty to assert that the pressure quality in hunger and nausea, for instance, is precisely the same; but, at any rate, analysis reveals a likeness which is surprising in view of the gross difference between the hungry and the nauseated consciousness. This perceptual difference will occupy us later (§ 104), as will also the question of internal localisation (§ 88).

**§ 58. The Sensations of the Circulatory and Respiratory Systems.**—For the most part, the action of heart and lungs is not accompanied by sensation. There are times, however,—after severe exertion, or during transient disturbance of function,—when the separate heart-beats are clearly sensed as a dull throbbing pressure: it is not easy to say whether the sensations are localised in the body

wall or in the heart itself. Further, when we are anxious or worried or apprehensive, we get a characteristic sense of oppression from the cardiac region. This may appear alone, or in connection with nausea or choking sensations of muscular pressure from the pharynx. The two latter experiences are so well-marked that they have received names in everyday speech; in the first case, we say that we have a sinking of the stomach, in the latter that the heart has come up to the mouth.

Again, it is supposed that circulatory sensations, due to the contraction of the walls of the blood-vessels, play a part in the experiences of shudder, shiver, and goose-flesh. Analysis is here very difficult. In shuddering, however, there is certainly a muscular element; in shivering, this is complicated by sensations of cold; and in goose-flesh we have, perhaps, besides pressure from the hair-bulbs, sensations from the contraction of the unstriped muscles. The tingling sensations that occur when circulation is suddenly restored to a benumbed limb — pins and needles, as they are called — are also, in all probability, to be ascribed to nerve-endings in the walls of the vessels.

A sense of oppression, not unlike that which comes from the cardiac region and often associated to it, appears in the chest in connection with disturbances of breathing. It may be induced by a cramped position of the body, as when one sits for a long time bent over a desk; or by bad air, as in a lecture or concert room; or by an unusual effort of respiration, as in the first stages of running, before the respiratory mechanism has become adapted and the runner, as we say, has got his second wind. At low intensities we speak of it as stuffiness; at the highest, as suffocation; when it is fused with cardiac oppression, as dis-

tress. It is probably to be referred to nerve-endings in the alveoli of the lungs, and is prominent in asthma and other dyspnoeic conditions. The bracing sense of fresh air, on the other hand, is due to sensations from the respiratory muscles.

§ 59. **The Sensations of the Genital System.**—Reproduction is one of the supreme vital functions; and the study of the reproductive organs, their development and mechanism, belongs accordingly to all divisions of the science of life, — to biology in the narrower sense, to comparative anatomy, to embryology and histology, and to physiology. These sciences have, as a matter of fact, devoted much attention to the various phases of the problem; they have ascertained facts, established laws, and worked out homologies and correlations. Especial interest has been taken, of recent years, in the questions of sexual pathology, not only in their medical, but also in their moral, social and legal aspects. It is the more surprising, then, that very little is known, psychologically, of sexual sensation.

There seems to be no doubt that all the reproductive functions may run their course reflexly, without any sort of conscious concomitant. Normally, however, the train of reflexes is under cerebral control. Sexual stimulation implies, besides sensations from the sex-organs themselves, a wide-spread arousal of other organic sensations, and a play of perceptions and ideas, visual, tactual and kinaesthetic. The special sensations of the genital system appear to occur in three stages: first as an irritation or excitement, which accompanies the tumescence of certain erectile tissues; then as sexual gratification, which culminates in the orgasm accompanying ejaculation or the consummation of the sexual act; and thirdly as relief, the sexual analepsis which follows coition.

Sexual excitement, so far as it is a matter of specific sensation, is usually described as a need of evacuation. Thus, Bain writes that "the appetite that brings the sexes together is founded on peculiar secretions which periodically accumulate within the system, producing a feeling of oppression until they are either discharged or absorbed."<sup>1</sup> This view, however, is negated by many lines of evidence. Sexual appetite and its satisfaction may persist after excision of the testes in the male and the ovaries, Fallopian tubes and uterus in the female; in children there frequently exists a well-defined sexual excitement long before there is any true sexual secretion; in adults the sensations may continue to appear long after the sexual glands have discontinued their functions; and, finally, there may be an intensive sexual life in the congenital absence of any sexual glands at all. Moreover, sexual irritability is localised, in the male on the surface of the glans penis, and in the female in the clitoris and the adjacent erectile parts. These organs are sexually sensitive even in the flaccid state, though the degree of sensitivity differs greatly in different individuals and even for the same individual at different times. Both in quality and in its irradiating character the sensation of sexual excitement resembles tickling. We do not know how it is aroused: there are no lust spots, akin to the sensitive spots of the skin, and the organs sometimes described as genital corpuscles are certainly not sexual in function.

Most authorities appear to regard the orgasmic sensations, in both sexes, as distinct and unique. It is, however, as difficult in their case as it is in those of hunger and nausea to say whether we are in presence of a novel quality or simply of a specific resultant of muscular and glandular activity. Since the sensations may appear after extirpation of testes and ovaries, the latter view would seem to be the more probable.

Sexual ~~analepsis~~ <sup>analepsis</sup> is made up, for the most part, of muscular sensations. It is a general sense, either of lightness and relief, or of lassitude and faintness, very like that which follows urination and defaecation: indeed, we may suppose that this resemblance is

<sup>1</sup> A. Bain, *The Senses and the Intellect*, 1868, 244.

mainly responsible for the evacuation theory of sexual sensation at large.

The sensations attending menstruation and parturition are those of muscular pressure, pain and strain, and sometimes of nausea; neither among them nor in the following anaesthetic states are new qualities found.

#### References for Further Reading

§§ 56-59. C. S. Sherrington, *Common Sensation*, in *Schäfer's Text-book*, ii., 1900, 965 ff.; H. Ellis, *Studies in the Psychology of Sex*, iv., 1903, 1 ff. (Analysis of the Sexual Impulse); E. Meumann, *Zur Frage der Sensibilität der inneren Organe*, in *Archiv für die gesammte Psychologie*, ix., 1907, 26 ff.

§ 56. Recent discussion makes it clear that the effect of a local anaesthesia is more extended than the surgeons at first supposed, so that certain of the arguments upon which the conclusions of this section are based must be regarded as invalid. The evidence is at present conflicting, and the discrepancies cannot be referred certainly either to individual differences of sensitivity or to differences in the technique of operations. The reader may consult E. Becher, *Ueber die Sensibilität der inneren Organe*, in *Zeits. f. Psych.*, xlix., 1908, 341 ff.; *Einige Bemerkungen über die Sensibilität der inneren Organe*, in *Arch. f. d. ges. Psych.*, xv., 1909, 356 ff.; E. Meumann, *Weiteres zur Frage d. Sensibilität d. inneren Organe u. d. Bedeutung d. Organempfindungen*, *ibid.*, xiv., 1909, 279 ff.

## SYNAESTHESIA

§ 60. **Synaesthesia.**—Every sensory stimulus of moderate intensity arouses a wide-spread reaction. It has been shown, for instance, that the sounding of a single note upon the harmonium will not only bring about an adjustment of the organs of hearing, but will also call out visual, verbal and other associations, often of considerable vividness and detail, as well as organic sets and attitudes of various kinds. Such a result is, perhaps, only natural, in view of the manifold connections within the nervous system,—though it comes as something of a surprise to those who are accustomed to look only at the local effects of stimulation.

Quite apart, however, from this general disturbance of the organism, it not infrequently happens that a stimulus sets up, besides its appropriate sensation, a secondary or concomitant sensation. The phenomena of synaesthesia, as it is called, are scattered over the whole range of sensation, and are extremely varied in nature. Sometimes they seem to depend upon a purely individual feature of nervous constitution, as when a sour taste makes the scalp itch; sometimes they are common to a large number of persons: most of us shudder and grit the teeth when we hear the squeak of chalk against the blackboard, or the grating sound of a saw upon metal. The connection may obtain between separate sense-departments, as sound and sight, or between different areas of a single sense-department; thus, an itching of the nose often comes along with

pricking sensations at the back of the neck on the same side, and the emptying of bladder or rectum is accompanied by a muscular shiver. In some cases, the concomitance is stable, in others it is highly variable; in some it is limited, as it were incidental, in others systematic, extending to an entire series of qualities.

The commonest form of systematic synaesthesia, known as coloured hearing, occurs almost as frequently as partial colour-blindness. In it, any auditory stimulus, noise, tone or sound complex, may arouse a photism or chromatism, a visual image of light or colour. No general rules can be laid down, since the associations vary for different persons and, within limits, may vary for the same person at different times. Two types, however, have been distinguished. In the one, the connection is direct; the sound calls up the sight without any intermediary; in the other it is indirect, by way of organic sensations.

The following case may be quoted in illustration. "The vowels of the English language always appear to me, when I think of them, as possessing certain colours. Consonants, when thought of by themselves, are of a purplish black; but when I think of a whole word, the colour of the consonants tends towards the colour of the vowels. For example, in the word 'Tuesday,' when I think of each letter separately, the consonants are purplish-black, *u* is a light dove colour, *e* is a pale emerald green, and *a* is yellow; but when I think of the whole word together, the first part is a light grey-green, and the latter part yellow. Each word is a distinct whole. I have always associated the same colours with the same letters, and no effort will change the colour of one letter, transferring it to another."<sup>1</sup>

In rare cases, colours accompany the sensations of taste and

<sup>1</sup> From a letter cited by F. Galton, *Inquiries into Human Faculty and its Development*, 1883, 149.



smell. Salt, for instance, is given by one observer as dull red, bitter as brown, sour as green or greenish blue, and sweet as a clear, bright blue. Colour concomitants of pain, pressure and temperature have also been recorded: thus, the plunging of the hands into cold water may be seen as bright red.

The synaesthetically aroused colours do not follow the lines of what we should suppose to be the least associative resistance. It is odd to read that "the word 'red' assumes a light-green tint, while the word 'yellow' is light-green at the beginning and red at the end." And while the observer just mentioned sees the taste of meat as red and brown, and that of bananas as yellow, he tastes Graham bread as a rich red, and all ice creams — except chocolate and coffee, which are brown because they have a bitter component — as blue.

Tonal vision, the systematic opposite of coloured hearing, seems not to occur. Incidental colour-phonisms have, however, been noted: in one case all the blues, bright as well as dark, are heard as deep and dull, and all the yellows as more or less high and ringing tones. Phonisms of pain, pressure and temperature are also known to exist. Recently, a case of gustatory (or rather gustatory-tactual) audition has been discovered; the sound of 'intelligence,' for example, tastes like raw sliced tomato, and the sound of 'interest' like stewed tomato!

It is clear that we cannot explain coloured hearing as we explain the shudder set up by a shrill or grating noise. The colours are presented to the mind's eye; they are, as we have said, images, not peripherally excited sensations. Nevertheless, several lines of evidence go to show that they belong to the domain of sensation rather than to that of the association of ideas. First, the concomitance of colour-image and sound is, in many cases, far too detailed and too persistent to be referred to association, in the ordinary sense of that word. It is impossible that the connections should have been established during childhood; it

is impossible, had they been thus established, that they should continue unchanged. Further, attempts have been made, by trained and interested observers, to trace back their synaesthetic experiences to associations formed in childhood; but in spite of all efforts they have ended in failure. Again, we should expect that an association due to experience would show, along with a certain measure of variation, an underlying agreement or correspondence; whereas, as Galton remarks, "no two people agree, or hardly ever do so, as to the colour they associate with the same sound." And lastly, coloured hearing is an hereditary trait; it tends strongly to run in families. While, then, it is possible, and even probable, that synaesthesia of the incidental type may be the legacy of some vivid or thrilling experience in early life, we are forced to the conclusion that, in general, it represents a congenital endowment. As to its physical basis, we can merely guess. It may depend upon some abnormal disposition of the paths of connection within the brain. Or possibly it may depend, as a recent writer has suggested, upon an unusual elasticity of the walls of the cerebral arteries. On this view, a rush of blood to the auditory centre might, owing to the extensibility of the arteries, be propagated to the visual centre; the hearing would be coloured. The theory accounts for the loss or reduction of synaesthesia as we pass from childhood to mature life, and for its occurrence in moments of emotional stress. As the arterial structure might be a matter either of inheritance or of individual peculiarity, it allows further for both the congenital and the acquired types of synaesthesia.

§ 61. **The Image.**—The facts of synaesthesia lead up to the question of the nature of the image, and of its dif-

ferences from sensation. It is usually said that the image differs from the corresponding sensation in three respects: its qualities are relatively pale, faded, washed out, misty; and its intensity and duration are markedly less.

Since these differences are all differences of degree, and not of kind, it should be possible to find experimental conditions under which the sensation and the image are confused. Experiments have, in fact, been made, and with positive result, in the fields of sight, sound and touch.

If, for instance, the observer is seated in a well-lighted room facing a sheet of ground glass, behind which is a screened projection lantern, it is often impossible for him to decide whether the faint colours that he sees on the glass are due to the lantern or to his own imagination. You say to him: Imagine that there is a picture of a banana on the glass!—and in many cases it makes no difference at all whether you show a strip of very faint yellow light from the lantern or whether you shut off the objective light altogether. The strip of seen yellow is confused with a yellow image. The experimenter, who regulates the course of the observations by signalling to a third person when the lantern is to be turned on, is sometimes greatly surprised at the gross errors made by the observer. What seems to him obviously sensory may be reported, without hesitation, as imaginative.

Again, we are frequently in doubt, in everyday life, whether we hear a particular sound or merely imagine it. And if, in the laboratory, the observer is required to listen intently to a continuous faint noise, such as is produced by the falling of a stream of fine sand (§ 81), the same confusion will be noted. The experimenter may reduce the stream to a mere trickle, and may finally stop it; the observer will still, in many cases, believe that he hears the hiss.

Lastly, a similar confusion is found in experiments upon pressure and tickling. If, for example, in the course of a series of stimulations of a pressure spot, the experimenter says Now! but

omits to touch the skin, the observer may, nevertheless, report the arousal of a pressure sensation.

It has been found, further, that a visually minded observer, who knows nothing of the laws of the negative after-image, may describe — and describe in correct terms — the after-images of merely imagined colours. It is also a matter of common knowledge that, in certain pathological states, the image may become what is called an hallucination, that is, may take on all the characters of clear and intensive sensation.

How is it, then, that we so rarely confuse image with sensation in our everyday experience? Well, the confusion may not be so uncommon as we suppose. However, if it is, the distinction may be accounted for, at any rate in large measure, by the differences of conscious context or setting in which the two processes appear. Images, for instance, seem to be less sharply localised than sensations; they change and shift more rapidly, and in a meaningless way; they move with movement of the eyes. But the writer is not sure that the image does not, as a rule, evince a sort of textural difference from sensation; that it is not more filmy, more transparent, more vaporous. If this is the case, then it is better to consider sensation and image as sub-classes of a particular type of mental element than to include them outright in a single class (§ 10).

Individual minds differ widely in the nature and frequency of their characteristic image-processes. Visual and auditory images are of common occurrence, although the auditory image appears, in general, to be connected with actual innervation of the larynx, that is, with kinaesthesia. Kinaesthetic images are extremely difficult to distinguish from kinaesthetic sensations. The difference, in the writer's experience, is largely a matter of complexity :

the mental nod which gives assent to an argument is more schematic, involves fewer muscles and involves them less solidly, than an actual nod. Images of taste and smell have often been reported, but only exceptionally play any considerable part in consciousness. Organic images are rare.

#### References for Further Reading

§§ 60, 61. E. Bleuler and K. Lehmann, *Zwangsmässige Lichtempfindungen durch Schall und verwandte Erscheinungen auf dem Gebiete der anderen Sinnesempfindungen*, 1881; F. Galton, *Inquiries into Human Faculty and its Development*, 1883; G. M. Whipple, *Two Cases of Synaesthesia*, in *American Journal of Psychology*, xi., 1900, 377; J. E. Downey, *An Experiment on getting an After-Image from a Mental Image*, in *Psychological Review*, viii., 1901, 42; O. Külpe, *Ueber die Objectivirung und Subjectivirung von Sinneseindrücken*, in Wundt's *Philosophische Studien*, xix., 1902, 508; R. Wallaschek, *Psychologie und Pathologie der Vorstellung*, 1905, 149; A. H. Pierce, *A Hitherto Undescribed Variety of Synaesthesia*, in *American Journal of Psychology*, xviii., 1907, 341; C. W. Perky, *An Experimental Study of Imagination*, *ibid.*, xxi., 1910, 422 ff.

## THE INTENSITY OF SENSATION

§ 62. **The Intensity of Sensation.**—All sensations have the attribute of intensity. A light may be bright or dull, a tone loud or faint, a pressure heavy or light, a taste strong or weak. If we take any given sensation as a starting point, we can travel from it in a straight line either towards zero, the point of its disappearance, or towards a maximum, the point of its greatest possible strength (§ 12).

The intensities that lie in order along this line are, in their way, as individual as are the qualities that lie, for instance, along any straight line of the colour pyramid. A loud tone is not a sum of two or three weak tones, but something entirely different from a weak tone. It may be reduced to a weak tone, if we move from high to low upon the intensive scale, just as a red may be reduced to pink if we move from red towards white; but it no more contains a number of weak tones than pink contains white. In other words, intensity of sensation must not be confused with intensity of stimulus. If we want to use a weight of 5 cg. in a balance, it makes no difference whether we take a single weight of 5 cg., or two of 2 and one of 1 cg., or five of 1 cg. If we want a light of 16 c. p. at a corner of a room, it makes no difference whether we take a single 16 c. p. bulb, or two of 8, or four of 4 c. p. Stimuli can be added, subtracted, multiplied; the greater, stronger stimulus contains or sums up a certain number of lesser, weaker stimuli of the same kind. It is otherwise with sensation.

You cannot get the heavy by adding together, mentally, a number of light, or the bright by adding together a number of dull: you cannot say that the heavy differs from the light by a certain fraction of the heavy or multiple of the light, or the bright from the dull by a certain fraction of the bright or multiple of the dull. Every intensity of sensation is itself, individual and characteristic: the intensive sensations represent, as we have said, points or positions upon an intensive scale which runs from a lower limiting value to a maximum, just precisely as a particular pink or olive represents a point within or upon the colour pyramid.

We live so habitually in a world of objects, and we think so habitually in terms of common sense, that it is difficult for us to take up the psychological standpoint towards intensity of sensation, and to look at consciousness as it is, apart from any objective reference. This book, we say, is heavier than that; this lamp gives the better illumination of the two; this piano has a louder tone than the others. Strictly interpreted, such statements may mean either one of two things. They may be taken physically, to mean that the books weigh differently in the balance, the lamps measure differently in c. p., the piano strings set up air-waves of different amplitude; or they may be taken psychologically, to mean that the books feel heavy and light, the lamps look bright and dull, the piano tones sound louder and less loud. As a rule, however, we are talking neither physics nor psychology, but a confused mixture of the two. It is true, of course, that we gauge the weight by lifting, the illumination by eye, and the strength of tone by ear. But, in doing this, we transfer to sensation the properties that really belong to stimulus: we think of the 'feel' of the heavier book as the 'feel' of the lighter with some more 'feel' added to it; we take the look of the bright lamp to be the same thing as the look of the dull, only with an addition; we regard the sound of the loud instrument as identical with the sound of the weaker, only that there is more



of it. In other words, we make the intensive sensation a copy of the intensive stimulus, and we assume that the strong sensation is built up by adding to the weak, and the weak produced by subtracting from the strong.

This fallacy of common sense is easily exposed by experiment. Take two glasses of sugared water, the one moderately sweet, the other very sweet, syrupy. Taste them in turn. Introspection declares at once that the tastes lie in the same straight line; the sweets are intensive variations of the same quality. But there is no hint — if you think only of the tastes themselves, and forget about the sugar — that the strong sweet contains the weak, is the sum of a number of weak. And it is impossible to imagine a third sweet which, if added to the weak, shall give the strong: the adding of sensation to sensation is meaningless, a task that you cannot lay hold of. The strong sweet lies fairly high up, the moderate sweet somewhat lower down, on the scale of sweet intensities. That is all.

Let us carry the experiment a little farther. Take, besides the two cups of sugared water, which we will call  $a$  and  $b$ , a number of others; make them all different, but let them all be sweeter than the moderately sweet  $a$  and less sweet than the syrupy  $b$ . Set the cups out upon a table,  $a$  and  $b$  to your left and right respectively, and the rest grouped at haphazard in the middle. Now try to pick out, by taste, a sweet  $c$  which lies for sensation midway between  $a$  and  $b$ : taste first  $a$ , then a cup from the middle group, and then  $b$ ; and keep on tasting until you are satisfied. If you take your time, and rinse the mouth between observations, so that the tongue is not cloyed, the task is rather surprisingly easy, — and the result is illuminating. For it means that we can measure off distances along the straight line which includes all the intensities of sweet; we can say by taste that the distance  $ac$  is equal to the distance  $cb$ , precisely as we can judge by eye that two spaces between the pictures on the wall are equal. Nothing could show more clearly that the intensive sensation is simply a point or position upon an intensive scale; and no experience could refute more decisively the common-sense notion that it is a copy of the intensive stimulus.

Within wide limits, the intensity of sensation may be treated as an independent variable: that is to say, we may discuss it without regard to quality, and may assume that it varies while quality remains unchanged. Nevertheless, it is important that the limits be recognised. We find, on the one hand, qualities that are intrinsically weak or strong; and we find, on the other hand, intensities that are bound up with definite qualities. In these cases, the two attributes must be considered together.

We noted in § 24 that high tones are intrinsically loud and low tones intrinsically weak. The lowest tones remain faint, even when the energy of stimulus is, relatively, very considerable; and high tones give the impression of loudness, even when their stimuli are little more than liminal. So, in the sense of taste, bitter is an intrinsically strong sensation, as compared with sour, sweet and salt. Conversely, there are many scents (violet, tea, vanilla) that are intrinsically weak: they are easy to detect, they are insistent (§ 12), but they are never strong as asafoetida or musk is strong.

Again, we have seen that intensive variation of punctiform pressure stimulus gives the qualitative series contact, pressure, granular pressure (§ 39), and of punctiform pain stimulus the series itch, prick, pain (§ 41); while the dragging sensation from the muscles and the sensation of tendinous strain both alike pass over, at high intensities, into dull pain (§§ 45, 46). The most striking instance of the connection of particular intensities with definite qualities is, however, afforded by visual sensation. A change in the intensity of visual stimulus not only renders the sensation brighter or duller (intensity), but also makes it lighter or darker (quality), and in the case of colour may change all three of the constituent attributes, hue, tint and chroma (§ 16). Some psychologists have argued from this that visual sensations do not possess the attribute of intensity at all; that brightness and lightness, dullness and darkness are simply differen-

names for the same qualitative characters.<sup>1</sup> Such a conclusion is, however, neither probable in itself nor supported by visual theory.

We saw in § 22 that the retinal processes which arouse the sensations of *Bk* and *W* are antagonistic and incompatible. If, then, a *Bk* and a *W* fall at the same time upon the same area of the retina, any one of three things may happen: the resulting processes may be equal in intensity as well as opposite in direction, and the retina may be undisturbed; or the *Bk* may be the stronger stimulus, and may set up a *Bk*-process of the intensity of  $Bk - W$ ; or the *W* may be the stronger stimulus, and may set up a *W*-process of the intensity  $W - Bk$ . In other words, a purely retinal vision would give us various intensities of *Bk* and *W*, but no sensations of grey. These relations are, however, complicated by the existence of the sensation of neutral grey, a cortical sensation of constant quality; and it is the addition of neutral grey to the retinal intensities of *Bk* and *W* that makes every change in the black-white series, as we actually have it, a change of quality as well as of intensity. A retinal *Bk*, of whatever intensity, must darken the cortical grey; a retinal *W* must lighten it: and darkening and lightening are shifts of quality. To secure intensive variation, with constancy of quality, we should have to increase the energy of the *Bk* and *W* components of the cortical grey, both together, in equal measure; but this is the very thing that the constitution of the retina forbids.<sup>2</sup> — In fine, then, intensity is an

<sup>1</sup> F. Hillebrand, *Ueber die spezifische Helligkeit der Farben*, in *Sitzungsberichte der kais. Akademie der Wissenschaften in Wien, Mathem.-naturw. Classe*, xcvi., Abth. iii., February, 1889, 88 f.; O. Kuelpe, *Outlines of Psychology*, 1909, 114.

<sup>2</sup> This explanation is due to G. E. Mueller: see *Zur Psychophysik der Gesichtsempfindungen*, in *Zeitschrift f. Psychologie u. Physiologie d. Sinnesorgane*, x., 1896, 31 ff.; xiv., 1897, 60 ff. —

We have to solve this problem of intensity for our own visual system; and our visual system is based upon the principle of antagonism. But it is quite possible that other eyes are built upon a different plan. It is possible, for instance, to think of a primitive eye, whose sensations should one and all be sensations of light (as opposed to sensations of dark) and should show a

attribute of visual as it is of all other sensations ; only, the dual nature, peripheral and central, of the visual apparatus brings it about that intensive change of a sensation of light necessarily involves transition to another quality. When this fact is taken into account along with the facts of § 16, the qualitative changes due to change of intensity in the sphere of colour (hue, tint and chroma) follow of themselves. —

So far, we have been considering cases in which the attributes of quality and intensity are interdependent. There are, further, many instances in which we cannot vary intensity without change of quality, merely because we cannot control the stimuli. For instance, it is impossible, except in the higher regions of the tonal scale, to produce a sensibly simple tone that is at all loud. If we take a flue pipe or a bottle, we find that increase of air-pressure sends the tone up ; if we take a tuning-fork, we find that a violent blow introduces complicating noises and overtones. Again, nothing might seem easier than to secure a graded series of intensities of noise ; all that we have to do is to let a ball drop from different heights upon a wooden plate. Experiment shows, however, that change in the height of fall is very likely to bring with it a change in the pitch, as well as in the loudness of the noise ; it is, as a matter of fact, difficult to maintain a constant quality of noise even within the comparatively short range of intensities required for laboratory work. Once more, the quality of what we have called resultant odours (§ 32) seldom remains stable over any wide extent of the intensive scale. It seems that the component stimuli behave differently, gain or lose in power to make themselves sensed, at different intensities ; though in a field where so little is known it is hazardous to risk an explanation.

regular intensive gradation. The world in which an organism possessed of such an eye would live might then be very light, light, moderately light, hardly light, or not light : the sensations of light would range between a maximal and a zero intensity, precisely as our own sensations of noise range between maximal loudness and silence, — that is, no noise at all. The organism would not distinguish, as we do, between light and dark, but would simply experience varying degrees of light. In the absence of an adequate light stimulus it would not, as we do, see dark, but would see nothing. Cf. § 15.

§ 63. **Mental Measurement.** — The psychological problem of the intensity of sensation is bound up, historically, with a much wider question, the question of the possibility of mental measurement. Every science tries to state its facts and to formulate its laws as precisely as possible, that is, in quantitative terms, in measured amounts. Thus, it is not enough to say that gravitation is a force which the earth exerts upon every particle of matter; it is not even enough to say that the force is proportional to the mass of the material body, but independent of the particular kind of matter of which it is composed: the physicist goes further, and measures the force of gravitation in terms of acceleration. Physics and chemistry are, indeed, from end to end, quantitative or measuring sciences. But biology, too, tries to measure: the modern biologist measures the range of variation shown by the members of a species, gives numerical expression to the factors that determine heredity, and so on. And psychology has to face the same issue. There are facts of mind and there are laws of mind: can, then, these facts and laws be quantified? can we measure mind? Now the question of the possibility of mental measurement has been chiefly discussed, as was said above, with reference to the intensity of sensation. Here, therefore, is the fitting place to take it up. We shall ask what measurement means; we shall ask in what sense, and to what extent, measurement may be applied in psychology; and we shall draw our illustrations from the study of sense-intensity, as defined in the preceding § 62. —

Whenever we measure, in any department of science, we compare a given magnitude with some conventional unit of the same kind, and determine how many times the unit is contained in the magnitude. If we say, for instance, that

a certain line is 5 cm. long, we mean that we have compared the line with the conventional unit of length, 1 cm., and have found that it contains this unit five times over. All measurement thus implies three given terms : the two limiting points of the magnitude to be measured (beginning and end, top and bottom, extreme right and extreme left, zero and maximum), and a third point lying at unit-distance from the one or the other limiting point.

The intensities of sensation lie, as we have said, along a straight line which extends from a zero-point to a point of maximal strength. Here is a magnitude with limiting points. In order to measure sense-intensity, — the intensity of sensations of light or tone or noise, of pressure or taste or smell, — we have, first, to establish these two points, definitely and accurately, and secondly to determine the unit of intensive measurement, the standard subdivision of the total line.

It is important to realise that the unit of measurement is always a conventional unit ; its choice is simply a matter of practical convenience. Scientific men are now generally agreed that the unit of physical space shall be the cm., the unit of time the sec., and the unit of mass the gr. There is, however, nothing absolute about these units. The metric system makes calculation easy, relates the three fundamental quantities in a very simple manner ; but that is its sole, as it is its sufficient, claim to acceptance.

And just as the unit of measurement is conventional, and the pace or the span, the ounce or the pound, will give us perfectly valid measures of space and mass, so also may our selection of the magnitude to be measured be arbitrary or conventional. The ordinary postal balance weighs up to 16 oz. ; the ordinary kitchen scales weigh up to 4 lb. We can measure — we can express by the number of contained units from zero to maximum — any magnitude that chance throws in our way.

But this means that our experiments with the cups of sugared



water (§62) was a quantitative experiment, a measurement of mind. We had, as our arbitrarily chosen magnitude, the sense-distance from the moderately sweet  $a$  to the syrupy  $b$ . Then we bisected that distance, by finding the sweet  $c$  that lay midway for sensation between  $a$  and  $b$ . The half-distance was our arbitrary unit; and we can write, in terms of it,  $ab = 2 ac = 2 cb$ , just as with a unit of 1 ft. we can say that the regular carpenter's rule contains 2 ft. The three points by help of which we have measured, the two limiting points  $a, b$  upon the intensive line of sweets and the point  $c$  which lies at unit-distance from the lower point  $a$ , can be established, for comparative purposes, by a statement of the relative amounts of sugar and water in the three solutions.

We may take another illustration of the same thing. Let the horizontal line in Fig. 25 represent the complete scale of sensation intensity in the sphere of noise.

And suppose that we have given the two noises  $m$  and  $o$ , a weaker and a stronger noise due, perhaps, to the falling of



FIG. 25.

two ivory balls from different heights upon ebony plates. By selecting from a number of intermediate noises, we may determine the noise  $n$  that lies midway for sensation between  $m$  and  $o$ . We may then write  $mo = 2 mn = 2 no$ . That established, we can take the distance  $no$  as given, and can compare  $no$  with distances above  $o$ , until we finally reach a point  $p$  such that  $no = op$ . We may then write  $mp = 3 mn$ . Again, we can take  $mn$  as given, and compare it with distances below  $m$ , until we reach the point  $l$  at which  $lm = mn$ . We may then write  $lp = 4 lm$ . And we can evidently go on to determine  $q, r, \dots$  and  $k, j, \dots$  in the same manner. So that, if we continue the procedure as far as possible towards the limits of the horizontal line of the Fig., we shall finally have measured the entire range of noise-intensities in terms of an arbitrary unit. Between the limits of the faintest and the loudest noise there will be so-and-so many steps, or distances, of the unit-magnitude  $mn$ . This is measurement of mind. —

In neither of the above instances, however, has the measurement



been methodical. We took any sweet-distance  $ab$ , and any noise-distance  $mo$ . It would have been more methodical to determine, at the outset, the two end-points of the total line of sweets and noises, to determine what are called the liminal and the terminal intensities of sweet-sensation and noise-sensation. Moreover, we took as our units of measurement  $\frac{ab}{2}$  and  $\frac{mo}{2}$ . Now we do not know, in the first place, whether or not these units fit the scale, whether they will divide it up without remainder. And, in the second place, we have no reason to think that other psychologists will adopt them: they do not recommend themselves, in any way, for general use, as comparable with the *c.g.s.* units of the physical sciences.

§ 64. **Liminal and Terminal Stimuli.** — The sense-organ, like any other mechanism, has a certain inertia, offers a certain amount of frictional resistance to stimulus; and has also a definite capacity, transmits so much energy and no more. Hence in all of the sense-departments there are stimuli that are too weak to be sensed, and in all there comes a point beyond which we cannot increase the intensity of sensation by any further increase of stimulus, but get the same response, over and over again, until the organ breaks down.

Instances of subliminal stimuli are not far to seek. Some lights are too faint to be seen: there are stars that, even on the darkest night, remain invisible to the naked eye. Some sounds are too weak to be heard: we know that the clock in the tower is ticking, because we see the hands move; but we have to climb the stairs to hear it. Some pressures are too slight to be felt: we have no knowledge, from the skin, of the flake of cigar-ash that has fallen upon our hand: and so on.

Maximal stimuli fall less commonly within the range of our experience. It is, however, easy to assure oneself that there is a point beyond which sugar cannot further sweeten or quinine make more bitter, and that a continued increase of pressure, after it has carried

the sensation of pressure to a certain height, is felt not as pressure but as pain. Dazzling lights and deafening noises set a like limit to the functional capacity of eye and ear.

The magnitude of stimulus which evokes the sensation at the lower end of the intensive scale, the first term of an intensive series, is known technically as the *liminal stimulus*. It may be determined as the stimulus which gives a positive result, evokes a sensation, in one-half of a long series of observations, while in the remaining one-half the result is negative or doubtful. This value, so the mathematicians tell us, is as nearly as possible identical with the magnitude of stimulus which, if all sources of error were completely eliminated, would call forth a barely perceptible sensation. Since, however, the liminal stimulus is not a constant but a variable, it cannot in strictness be represented by any single value, not even by the most probable value; its formula must always be written  $x \pm y$ , where  $x$  is the most probable value of the stimulus and  $\pm y$  indicates its range of variation.

The magnitude of stimulus which evokes the sensation at the upper end of the intensive scale, the last term of an intensive series, is known technically as the *terminal stimulus*. Theoretically, it may be determined in the same way; in practice it is rarely approached, out of regard for the integrity of the organ.

A variable quantity is a quantity which varies with change of the conditions under which an observation is made. Thus, a measurement in physics may vary with temperature, with humidity, with stress, as well as with the delicacy of graduation of the measuring instrument. The experimenter seeks, so far as possible, to keep all the conditions constant while a measurement is in progress; but even so there will be a slight range of variation. And the

result is always stated in a qualified way, with reference to the conditions.<sup>1</sup>

The liminal stimulus is, in this sense, a variable; and its variation is due partly to the sense-organ and partly to the brain. When we are tired, for instance, our sense-organs are dulled and our general disposition is unfavourable to close work; the liminal stimulus is, accordingly, much larger than it is when we are fresh. But even under the best conditions there is fluctuation. The organic mechanism, made up of sense-organ and brain, is extraordinarily complicated, and complex machinery gets out of order more easily than simple. Besides, the organic mechanism is plastic, not rigid; it is influenced by all sorts of things, — directly by nutritive factors, indirectly by the state of all the rest of the organism. The wonder is, indeed, not that the liminal stimulus should be a variable quantity, but that it should be so nearly constant, for normal persons, as in fact it turns out to be.

The exact determination of the liminal stimulus, that is, of the amount of mechanical energy required to arouse a sense-organ to response, is a very delicate and difficult matter, and a knowledge of methods and results is of interest only to the special student. It must suffice here to say that, for most of the organs, the measurement has been made.<sup>2</sup> In ordinary laboratory practice it is enough to take a rough determination in empirical terms. Thus,

<sup>1</sup> If there is anything constant in the world, it would seem to be the length of the standard metre, which is the unit of reference for all linear measurement in physics. Yet we are told that "from the result of many years of comparison at the Bureau International [in Paris], the conclusion is reached that the length of a standard can be absolutely guaranteed to an exactitude of about 0.2 micron at all usual temperatures" (W. Hallock and H. T. Wade, *Outlines of the Evolution of Weights and Measures and the Metric System*, 1906, 256). In this statement, the measurement is qualified, first by reference to temperature, and secondly by a statement of the range of variability; a micron is a millionth of a metre. A measure that is correct to one five-millionth is, to all intents and purposes, a constant; it would be to all intents and purposes a constant if the variation were far greater. In strictness, however, it is a variable.

<sup>2</sup> See, for instance, S. P. Langley, *Energy and Vision*, *Philosophical Magazine*, xxvii., 1889, 1.

a couple of hours of methodical work will settle the question from what height a leaden shot of a given weight must fall upon a glass

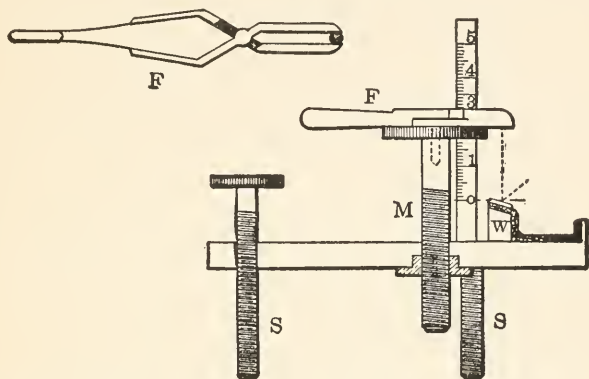

FIG. 26. Acoumeter for determining the Stimulus Limen of Noise. *SS*, set-screws (two of the three are shown), supporting a wooden platform. *M*, micrometer screw at the centre of the platform, with scale beside it. *FF*, spring forceps, lying on the head of *M*, and carrying a small shot for dropping on the glass plate above *W*. The shot rebounds, and falls noiselessly into a padded trough.

plate if the noise is to be just audible to an observer seated 10 m. away. Results of this kind are useful, as means of comparison, but have no general scientific value.

§ 65. **The Just Noticeable Difference as the Unit of Measurement.** — We defined the liminal stimulus, or the just noticeable stimulus, as that magnitude of stimulus which evokes a sensation in one-half of a long series of observations, while in the remaining one-half the result is negative or doubtful. If, now, we take a second stimulus of the same magnitude, and gradually increase its intensity by very small amounts; and if, at every step of this progression, we compare the sensations set up by the two stimuli: then we shall presently arrive at a stimulus-difference which behaves in the same way as the liminal

stimulus itself. We shall, that is, come to a difference which is perceived as a difference in one-half of a long series of observations, while in the remaining one-half there is no perceptible difference, or the observer is in doubt. And the procedure may be repeated, again and again, until we have traversed the whole or a large part of the intensive scale.

It has been suggested that this difference, which is known as the just noticeable difference of stimuli, or as the differential limen of sensation, may be regarded as the natural unit of the scale of sensible intensity. The zero-point of the scale is given with the liminal stimulus, or (as it is called, with reference to sensation) the stimulus limen. The end-point of the scale is given with the terminal stimulus. The units of the scale will then be given with the series of just noticeable differences as defined above. For, it is said, the just noticeable differences correspond to least distances upon the sense-scale, minima of sensible distance. Now least distances, being the smallest possible distances at which sensations can be distinguished, are necessarily equal distances; and equal distances are the very things that we are in search of, to furnish the subdivisions of our mental scale.

Logically, however, this argument is not sound. It is by no means self-evident that least steps, at various parts of the sense-scale, should also be equal steps. A given difference between sensations might be the least perceptible difference, and yet, as compared with another least perceptible difference from another part of the scale, might be larger or smaller. The equality of just noticeable differences must, then, be proved; it cannot be assumed. The appeal lies to the results of experiment.

We shall see in the next § 66 that the results of experiment are ambiguous. Nevertheless, the preponderance of the experimental evidence is, in the writer's judgment, very definitely in favour of the equality of the just noticeable differences; the discrepant results can be accounted for in terms of known sources of error. We return to the point later.

In the meantime: Why, it may be asked, should we not appeal to introspection? Why should we not directly compare two just noticeable differences, from different regions of the intensive scale, and see if they are alike or different?—For the simple reason that they are the results of measurement. If mere observation were enough, we should not need to measure at all, in any field of science. If we could estimate the sixtieths of a circle, it would not be necessary to mark off the clock-face into minutes; if we could estimate spaces of so many feet, it would not be necessary to secure architects' plans before we built a house. The just noticeable difference is not determined by a single introspective observation, and cannot be carried in the head as a standard of magnitude: it is the calculated result of a long series of introspective observations, and stands for a most probable or representative value. The whole object of measurement is to carry accuracy into fields in which mere observation, simple estimation, is inaccurate.

§ 66. **Weber's Law.**—If we determine a series of just noticeable differences, in the middle region of the intensive scale, we find a very simple relation between change of sensation and increase of stimulus. At the beginning, where the stimuli are relatively weak, only a small addition is required to effect a noticeable increase in the intensity of sensation; as the series progresses, the additions become larger and larger; and towards the end, where the stimuli are relatively strong, the largest additions are needed. And this progressive increase of the stimulus-increment is uniform: so that, in general, the series of least sense-

distances corresponds to a series of stimulus-increments that are, approximately, equal fractions of the original stimulus. Thus, if we start with the stimulus 10, and find a just noticeable difference with the stimulus 11, then when we come to 20 we shall find a difference with 22, when we come to 30 we shall find it with 33, and so on.

If, therefore, we could regard all just noticeable differences as equal, — all least sense-distances as equal sense-distances, — we could sum up the results of our experiment by saying that an arithmetical series of sense-distances corresponds to a geometrical series of stimulus-values. We should have, on the side of sensation, a series of intensities  $0^1$ , 1, 2, 3, 4, . . ., lying at points equidistant upon the intensive scale; and we should have on the side of stimulus a progression of the order  $R$ ,  $R(1+r)$ ,  $R(1+r)^2$ ,  $R(1+r)^3$ , . . ., where  $R$  is the first stimulus taken (here the stimulus 10, correlated with the sensible intensity 0), and  $r$  is a certain fractional part of  $R$  (here, one-tenth).

We can put the question to the test of experiment. Let us take, for instance, the case of sensations of light. We know, from many investigations, that a succession of just noticeable differences of light-sensation is paralleled by a geometrical series of physical light-stimuli. Now we have recourse to larger, supraliminal differences of light-sensation. We set up on the colour-mixer (Fig. 4) three compound discs of black and white paper. The two outer discs are adjusted to give on rotation a dark and a light

<sup>1</sup> This 0 is not, of course, the zero-point of intensity of sensation at large: it is only the zero-point of our arbitrarily selected scale, and therefore stands for the intensity of sensation with which the experiments begin. — If we are measuring a table with a foot-rule, we begin with 0, in just the same way; but we do not mean that space at large begins where our rule begins.



grey respectively; they remain constant throughout the experiment. The proportion of black and white in the middle disc is varied, until a grey is obtained which lies, for sensation, midway between the extremes. Our three rotating discs then show two equal sense-distances, of much more than liminal extent. What of the stimuli? The stimuli, measured by means of the photometer, prove to form a geometrical series; their photometric values differ, not by equal amounts, but by relatively equal amounts.

Here, however, is the answer to our question. Here we have an arithmetical series of sense-distances, two successive distances guaranteed equal by introspection, corresponding to a geometrical series of light-stimuli. Since, then, we found a geometrical series of stimuli corresponding to our series of just noticeable differences of sensation, it follows that these just noticeable differences must themselves be psychologically equal. The just noticeable difference may be accepted as the unit of the intensive scale.

A strictly methodical procedure is as necessary in this case as it was in the case of the just noticeable difference: we do not discover the equality of the two sense-distances by direct introspection, but we calculate the most probable point of equality from a long series of introspective observations. The difference in the two experiments is this: that in the determination of the just noticeable difference the observer reports the likeness or difference of two sensations, whereas in the present experiment he reports the likeness or difference of two sense-distances. Hence we have, with supraliminal differences, an introspective control that is lacking for the liminal.

At the same time, the change from comparison of sensations to comparison of sense-distances may have a decided influence upon the observer's judgment. We said above (§ 65) that the results

of experiment were ambiguous. As a matter of fact, several recent investigations have led to the result that equal supraliminal distances, determined in the way just described, do not contain — as on our view they should — equal numbers of just noticeable differences, but that, on the contrary, the higher of the two contains fewer just noticeable differences than the lower.<sup>1</sup> And this result has been interpreted to mean that the just noticeable difference is a magnitude that increases with increase of stimulus, so that it cannot serve as the unit of measurement. However, another interpretation is possible. The upper distance, which contains the fewer just noticeable differences, may in reality be shorter than the lower; the observer's judgment that the two distances are equal may be erroneous. For one very dangerous source of error, in experiments upon the comparison of supraliminal sense-distances, is that the observer tends to judge, not in terms of sensation, but in terms of stimulus. He thinks, not of the light-sensations, but of the grey papers; not of the sounds heard, but of the heights from which the balls must have fallen to give those sounds (§ 62). If this error, which is known technically as the stimulus-error, creeps into the observations, then the stimuli which delimit the two sense-distances are likely to form, not a geometrical, but an arithmetical series. The consequence is plain. The upper distance must now contain fewer just noticeable differences than the lower; it is not psychologically, but only physically, equal to the lower. The observer, who was called upon to space out intensities of sensation, has really spaced out, in the light of his everyday experience, characters or properties of material things; and his spacing has, naturally, led to an approximate physical equality. — This, in general, is the writer's explanation of the discrepancies in the experimental results.

The law that equal sense-distances correspond to relatively equal differences of stimulus is known as Weber's Law. It has been found to hold, at least approximately

<sup>1</sup> See, e.g., W. Ament, *Ueber das Verhältnis der ebenmerklichen zu den übermerklichen Unterschieden bei Licht- und Schallintensitäten*, in Wundt's *Philosophische Studien*, xvi., 1900, 135.

and within a certain middle region of the intensive scale, for intensities of noise and tone, of light, of pressure, of various kinaesthetic complexes (lifted weights, movements of the arm, movements of the eyes), and of smell. Its validity in the fields of taste and of temperature is doubtful. It may possibly hold for affection (§ 73), as well as for sensation; but no experimental test in the sphere of feeling has as yet been made.

In 1834 the German physiologist E. H. Weber (1795-1878) performed some experiments with weights and visual distances which seemed to establish a constancy of the relative differential limen.



FIG. 28. Pair of black-and-white discs for the demonstration of Weber's Law. The brightness of the left-hand disc increases, from the centre towards the periphery, in geometrical progression; that of the right-hand disc increases in arithmetical progression. — A. Kirschmann, *American Journal of Psychology*, vii., 1896, 386 ff.; E. C. Sanford, *A Course in Experimental Psychology*, 1898, 335 f.

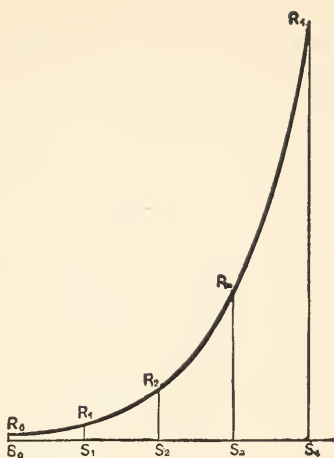

FIG. 27. Generalised representation of the relation between  $S$  and  $R$  formulated in Weber's Law. Equal sense-steps are marked off as abscissas, and the corresponding  $R$ -values are entered as ordinates.

He accordingly concluded that "what we perceive, when we are discriminating between objects, is not their absolute difference, but rather the proportion which the difference bears to their magnitude." G. T. Fechner (1801-1887) gave the law a precise phrasing, and put it to elaborate experimental test. Although Fechner's modesty led him to name it after

Weber, we might more correctly term it Fechner's Law or the Weber-Fechner Law.

Fechner formulated the law in the equation  $S = c \log R$ , where  $S$  stands for intensity of sensation,  $R$  for stimulus, and  $c$  for a constant factor. Fechner's understanding of the formula was wrong; he fell into the very common error which we discussed in § 62. The formula itself, however, may be retained. Here is its derivation in terms of supraliminal sense-distances.

We know, from our experimental results, that the magnitude of a sense-distance is dependent upon the quotient of the two  $R$  that limit it. Let the dependence be expressed by the mathematical sign of function,  $f$ . Then we have, for two successive sense-distances, the equations:

$$\overline{S_1 S_2} = f\left(\frac{R_1}{R_2}\right),$$

$$\overline{S_2 S_3} = f\left(\frac{R_2}{R_3}\right).$$

Adding these equations, we get:

$$\overline{S_1 S_3} = f\left(\frac{R_1}{R_2}\right) + f\left(\frac{R_2}{R_3}\right).$$

But we know, again from our experiments, that:

$$\overline{S_1 S_3} = f\left(\frac{R_1}{R_3}\right)$$

and, of course,

$$f\left(\frac{R_1}{R_3}\right) = f\left(\frac{R_1}{R_2} \cdot \frac{R_2}{R_3}\right).$$

We have, then, finally:

$$f\left(\frac{R_1}{R_2}\right) + f\left(\frac{R_2}{R_3}\right) = f\left(\frac{R_1}{R_2}\right) \cdot \left(\frac{R_2}{R_3}\right).$$

Now the only continuous function that can satisfy an equation of this form is, as we learn from the mathematical text-books, a logarithmic function. Hence we may write (inserting a constant factor,  $c$ , to indicate our choice of some particular logarithmic system)

$$\overline{S_1 S_2} = c \log \frac{R_1}{R_2},$$

$$\overline{S_2 S_3} = c \log \frac{R_2}{R_3}.$$

Or, in general, if  $S_0$  and  $R_0$  denote the  $S$  and  $R$  with which we start, and  $S$  and  $R$  themselves denote any other sensation and its corresponding stimulus-value :

$$\overline{S S_0} = c \log \frac{R}{R_0}.$$

And, lastly, if we denote the intensive  $S$ -distances reckoned from an initial  $S_0$  by  $\mathbf{S}$ , and the  $R$ -intensities calculated in terms of the corresponding  $R_0$  by  $\mathbf{R}$ , we have simply :

$$\mathbf{S} = c \log \mathbf{R}.$$

The formula may also be derived, though not without help from the calculus, in terms of liminal sense-distances or just noticeable differences.

§ 67. **Theory of Weber's Law.**— Every sense-organ, we said in § 64, offers a certain amount of frictional resistance to stimulus; it is this resistance that explains the fact of the stimulus limen. There can be no doubt that the differential limen is a fact of the same order, to be explained in the same way. Whatever the present state of the sense-organ may be, whatever excitatory processes are already in progress within it and within the connected parts of the central nervous system, the same sort of resistance is offered to an incoming stimulus. When the nervous machine has once been started, it will continue to work, without interruption, so long as adequate stimulation is continued: or, in other words, when sensation has once been set up, it will follow, continuously, the changes of stimulus. But if the stimulus cease for a moment to act,

the machine becomes inert, and must be started up again as if it had completely run down.

Intrinsically, therefore, the relation between sense-distance and stimulus-difference, which is expressed in Weber's Law, is a continuous relation; intensity of sensation is a continuous function of intensity of stimulus. In this sense, Weber's Law explains the facts of sensible intensity just as Hering's theory of vision or Helmholtz' theory of audition explains the facts of sensible quality. Weber's Law is itself the theory of sensible intensity. But the continuous function is changed, under certain conditions, into a discontinuous function; we have to explain the limens. And we explain them, stimulus limen and differential limen alike, by reference to the inertia of the nervous mechanism.

An illustration may help to make things clearer. If a magnetic needle is suspended at the centre of a circular coil of wire, and an electric current is sent through the wire, the needle is deflected from its position of rest. The angle of deflection is, however, not directly proportional to the strength of current. As the strength of current is increased, by equal amounts, the deflection of the needle becomes progressively smaller and smaller. The mathematical expression of the relation is very simple. If  $a$  is the number of amperes in the current,  $k$  a constant, and  $\theta$  the angle of deflection, then  $a = k \tan \theta$ . — Here is an expression that is very like the  $S = c \log R$  of Weber's Law; and both formulas are the expression of a continuous function.

Now suppose that the needle is hanging steady, whether at the zero-point of its scale or at any other point at which it is held by the current in the coil, and that we increase the current very slowly. At first we get no movement at all. Presently, however, when the current has been increased by a certain amount, the needle goes with a little jump to the position which the formula requires. In this case, we have two phenomena before us. On

the one hand, the needle is a magnetic needle, and the amount of its deflection is a continuous function of the current in the coil. On the other hand, the needle does not move, from any position of rest, without friction; so that under the conditions of our second experiment we observe, not a continuous movement, but a series of jerks. In just the same way, we have for intensity of sensation the continuous function expressed in Weber's Law; but we also have the stimulus and the differential limens as facts of friction.—

From the point of view of experimental psychology, Weber's Law has a very special significance, as summing up the results of the first successful attempt at mental measurement (§ 63). At the present time, methods of measurement, — metric methods, as they are technically called, — have been employed in many other fields of the mental life. Indeed, while little has been done in comparison with what still remains to do, there is no doubt that, in principle, every single problem that can now be set in psychology may be set in quantitative form. The psychological textbooks of the next century will be as full of formulas as the textbooks of physics are to-day.

The Law is also of great importance in our daily life, since wherever it is valid we are governed, not by the differences, but by the quotients of the intensive stimuli that affect us. It is because Weber's Law holds for a middle range of light-intensities that we are able to ignore the manifold changes of illumination to which we are exposed in the course of the daylight hours. It is for the same reason that the painter, who cannot at all reproduce by his pigments the absolute intensities of light in nature, can nevertheless furnish a recognisably true copy of any natural scene. And again, it is because Weber's Law holds for a middle range of sound-intensities that a large block of seats in the concert-room, at a moderate distance from the stage, can all be sold at the same prices and all have equal advantages for hearing.



## References for Further Reading

§§ 62-67. A general account of the problems of mental measurement is given in the author's *Experimental Psychology*, II., i., 1905, Introduction; and an historical sketch of the course of experiment, *ibid.*, II., ii., 1905, Introduction: *The Rise and Progress of Quantitative Psychology*. References of especial importance are: E. H. Weber, *Der Tastsinn und das Gemeingefühl*, an article in R. Wagner's *Handwörterbuch der Physiologie*, iii., 2, 1846, 481 (also published separately, 1849, 1851); G. T. Fechner, *Elemente der Psychophysik*, 2 vols., 1860 (1889, 1907), esp. i., chs. vi.-x.; G. E. Müller, *Zur Grundlegung der Psychophysik*, 1878; *Die Gesichtspunkte und die Tatsachen der psychophysischen Methodik*, 1904 (also in L. Asher and K. Spiro, *Ergebnisse der Physiologie*, II., ii., 266); J. Delboeuf, *Éléments de psychophysique générale et spéciale*, 1883; *Examen critique de la loi psychophysique, sa base et sa signification*, 1883; H. Ebbinghaus, *Ueber negative Empfindungswerte*, *Zeitschrift f. Psychologie u. Physiologie d. Sinnesorgane*, i., 1890, 320, 463; W. Wundt, *Grundzüge d. physiologischen Psychologie*, i., 1908, 525.

## AFFECTION

§ 68. **Feeling and Affection.**— The word ‘feeling’ is used in a great variety of meanings. A thing feels rough or smooth, hard or soft, sharp or blunt, firm or shaky, warm or cold, elastic or brittle, thick or thin, clammy or oily. We ourselves feel hungry or thirsty, fresh or tired, energetic or lazy, strong or weak, well or ill. We also feel comfortable or uncomfortable, we feel at home or strange, at ease or ill at ease, natural or constrained; we feel happy, cheerful, restless, angry, irritable, eager, calm. We feel hopeful, despondent, grieved, hurt, injured, relieved, contented, gloomy, anxious, annoyed. We feel indifferent, and we feel sympathetic; we feel the difficulty of an objection, the truth of an argument, the nobility of a character, the sacredness of a belief. ‘Feel’ and ‘feeling’ seem, indeed, to be psychological maids of all work; they can do, in the sentence, practically anything that a verb and a substantive can be called upon to do. There is little hope, one would think, of turning them to strict psychological account, and of giving them a place in a list of technical terms.

Let us see what happens, however, if we contrast feeling with sensation. Suppose that I say to you: The organism not only senses, but also feels; consciousness is made up, not of sensations alone, but of sensations and feelings. Here, surely, there is a hint or suggestion, vague though it may be, of the true psychological meaning of

'feel' and 'feeling.' You realise that stimuli do something more than arouse sensation; they give rise to processes of a different kind, to 'feelings' in a special sense; we do not merely take the impressions as they come, but we are affected by them, we feel them; and what we feel is their agreeableness or disagreeableness, their pleasantness or unpleasantness. Colours and tones, tastes and smells, may be pleasing or unpleasing just as obviously and just as directly as they are red or *c*, bitter or musky; and their pleasant or unpleasant character is a matter of feeling.

We have gained something, then, by contrasting feeling with sensation; we have found a fairly definite meaning for the term, and we have marked off a new field of mind for further study. At this point, unfortunately, the views of modern psychologists begin to differ; the psychology of feeling is still, in large measure, a psychology of personal opinion and belief. The writer holds that there is an elementary affective process, a feeling-element, which in our own minds is coordinate with sensation and distinguishable from it, but which is nevertheless akin to sensation and is derived from the same source, made (so to speak) out of the same kind of primitive mental material: this elementary process is termed affection. He holds, further, that there are only two kinds or qualities of affection, pleasantness and unpleasantness. The principal reasons for and against this view are set forth in the following sections.

If we look carefully at a list of 'feelings,' such as that given at the beginning of this § 68, we find that the experiences in question fall into three main groups. We have, in the first place, certain perceptions of touch: hardness, roughness, solidity, etc. We have, secondly, certain complexes of organic sensations: hunger,

fatigue, etc. And we have, thirdly, a number of mental processes which differ markedly in various ways, but which are all characterised by the predominance of pleasantness or unpleasantness: joy, sorrow, anger, difficulty, etc.

In ordinary speech, we oppose 'feeling' to 'intellect'; the man who is swayed by feeling is contrasted with the man who acts coolly and deliberately, by reasoned judgment. This use of the term is so natural and so habitual that we shall do well to keep it in psychology. 'Feeling' will then be the general name for all sorts of pleasant-unpleasant experience, for every form of emotion, mood, sentiment and passion. All the items in the third division of our list will be rightly called feelings.

But 'feeling' is also used, in psychology, in a narrower and more technical sense. It denotes a simple connection of sensation and affection, in which the affection preponderates. Hunger, for instance, is a sensation. But we may speak of a feeling of hunger if we mean a jolly hunger or a gnawing hunger; if, that is, we mean a pleasantly stimulating or an unpleasantly insistent hunger. Pain, again, is a sensation; and it is a sensation that, at different intensities and under different circumstances, may be pleasant, indifferent, or unpleasant. Usually it is unpleasant, and strongly unpleasant. When this is the case, we speak in psychology of a feeling of pain. And in just the same way we may speak of a feeling of fatigue, of nausea, of drowsiness, of freshness, of bodily strength. All the items in the second division of our list are rightly called feelings, in this narrower meaning of the term, provided that the sense-quality is accompanied by an intensive affection, pleasant or unpleasant. They are feelings proper, or sense-feelings.

The items of the first division are not feelings at all, but perceptions; and they are termed perceptions, as well as feelings, in the language of everyday life. In their case, psychology has no choice; the name 'feelings' must be given up. We shall, however, have something further to say about them in § 69.—

In summary, then, we have the following terms. *Affection* is an elementary mental process. Affection is the characteristic element in emotion, in love and hate, joy and sorrow, just as sensa-

tion is the characteristic element in perception, and image the characteristic element in idea (§ 10). *Feeling* in the narrower meaning of the word, sense-feeling, is a simple connection of affection and sensation, in which the affective element predominates: in this sense we are said to feel sleepy, tired, hungry, rested. *Feeling*, in the wider meaning of the word, is the general name for the affective side of our mental life: in this sense we are said to feel glad or sorry, worried or hopeful, proud or ashamed. There is no reason why the two meanings of 'feeling' should lead to confusion, and we shall be careful not to confuse them in this book.

§ 69. **Affection and Sensation.** — We have now to enquire into the nature of affection, considered as an element of mind; to ask how it resembles and how it differs from sensation. We will take the resemblances first.

Sensation was defined, in § 12, as an elementary mental process which is constituted of at least four attributes, — quality, intensity, clearness and duration. Now affection has three of these attributes, — quality, intensity, and duration; it thus appears as a process of the same general kind as sensation, and it may be defined on the same lines, by reference to attributes which are common to both. Affection has qualities: it has at least the two qualities of pleasantness and unpleasantness, and (as we shall see in § 72) some psychologists believe that it has many more. Affection shows differences of intensity: an experience may be mildly pleasant, slightly disagreeable, or wonderfully pleasant, unbearably disagreeable. And affection shows differences of duration: pleasure may be momentary, or may persist as a permanent mood; and unpleasantness behaves in the same way. So far, then, there is a general resemblance between affection and sensation.

Again: we have seen that certain sensations show the

phenomenon of adaptation. In many departments of sense—in pressure, in temperature, in smell, in taste—a sensation may disappear, fade out of consciousness, if the stimulus is continued. Sight, too, obeys the law of adaptation. We do not, it is true, become blind under visual stimulation; but our vision is reduced to a neutral grey, the quality of the persistent central excitation (§ 18). Precisely the same phenomenon of adaptation appears in the case of affection. If we are exposed for a long time together to the same stimulus, we may cease to be affected by it at all. The cookery of a foreign country is, when we first make acquaintance with it, distinctly pleasant or unpleasant; but in either case it quickly becomes indifferent. Dwellers in the country do not find the pleasure in country sights and odours that the townsman does; they have grown used to their surroundings. The whirl of a sewing machine in the room above that in which we are working may at first be extremely annoying; but as we become accustomed to it, its unpleasantness disappears. There is, indeed, no region of mind in which this law of affective adaptation fails to manifest itself. During the first few weeks of our stay in a beautiful neighbourhood we may be continually delighted with the colours and forms of the landscape. But we soon grow indifferent to them: fields and hills and streams are seen as clearly as ever, but they have ceased to excite pleasure. On the other hand, a piece of vulgarity which at first offends us may be taken as a matter of course if constantly repeated among those in whose company we are thrown. Here is a second point of likeness between affection and sensation.

The fact of affective adaptation seems to show as clearly, in these instances, as the fact of olfactory adaptation showed in the

instances of § 32. Nevertheless, it has been disputed; some psychologists explain the phenomena in terms of sensory adaptation. It is, they say, the cookery and the landscape that we grow accustomed to, not the disagreeableness of the dishes and the beauty of the landscape. There are, that is, as many possibilities of sensory adaptation as there are attributes of sensation; we may become adapted to intensity and clearness and duration, precisely as we become adapted to quality. If a friend asks us: "Doesn't that sewing machine annoy you?" we shall be likely to reply: "No! it would if I heard it, but I simply don't hear it any more." And the answer, these psychologists say, is correct; we have become adapted, not to the quality of the noise, but to its intensity and clearness; we have ceased to attend to it; it is no longer effective as a stimulus, and so its original disagreeableness has naturally lapsed. We have grown used, not to the disturbance, but to the noise; and the noise is now, as a result of our adaptation, both weak and obscure.

In the case of the sewing machine, this explanation is possible. But it is not convincing; for we may very well have become adapted both to the sensation and to the affection; the two adaptations may have gone along side by side. And in other cases, in which the stimulus is not continuous but intermittent (mealtimes, country walks, the behaviour of acquaintances), affective adaptation seems obvious. I may be keenly aware of the odour of garlic, and yet be entirely indifferent to it. I may take sharp note of the fact that the person with whom I am talking begins to use his toothpick, and yet have no feeling of disgust. We shall see, in § 78, that it is possible to attend without feeling; and if it is, if the sensation that fills the chief place in consciousness may be indifferent, then affective adaptation is certain. The objection shows, however,—what we have already insisted on,—that it is hardly possible to take a single step in the psychology of feeling without meeting contradiction and conflict of opinion.

Thirdly, the processes of pleasantness and unpleasantness show a strong introspective resemblance to organic sensations. Pleasantness seems akin to health, drowsiness,



bodily comfort, repletion; unpleasantness seems akin to pain, bodily discomfort, over-fatigue, lassitude. No doubt these experiences, as they present themselves in everyday life, are more than sensations; they are sense-feelings, complexes of affection and sensation; the total conscious experience that we call health, for instance, contains a pleasant affection along with various, kinaesthetic and other, sensory processes. Still, if we analyse repletion or fatigue, and so far as possible set off the affective element from the constituent sensations, the resemblance appears to persist. Affection is like organic sensation in much the same sense in which sensations of taste are like sensations of smell (§§ 29, 36).

In fine, affection resembles sensation in the nature of its attributes and in its behaviour when a stimulus is long continued, while the qualities of affection, pleasantness and unpleasantness, show an intrinsic likeness to the qualities of organic sensation. What, now, are the differences?

The first difference is this: that affection lacks the attribute of clearness. Pleasantness and unpleasantness may be intensive and lasting, but they are never clear. This means, if we put it in the language of popular psychology, that it is impossible to attend to an affection. The more closely we attend to a sensation, the clearer does it become, and the longer and more accurately do we remember it. But we cannot attend to an affection at all; if we attempt to do so, the pleasantness or unpleasantness at once eludes us and disappears, and we find ourselves contemplating some obtrusive sensation or image which we had no desire to observe. If we want to get pleasure from a concert or a picture, we must attend to what we hear

and what we see; so soon as we try to attend to the pleasure itself, the pleasure is gone.

The lack of the attribute of clearness is sufficient, in itself, to differentiate affection from sensation; a process that cannot be made the object of attention is radically different, and must play a radically different part in consciousness, from a process which is held and enhanced by attention. And it should be noted that lack of clearness distinguishes affection from organic sensation as definitely as from sensations of sight or hearing; we have no difficulty in attending to the sensory components of hunger and thirst and fatigue.

There is, however, a further difference. Pleasantness and unpleasantness are, what their names imply them to be, opposites. The opposition is not a matter of contrast, as this term is used in the psychology of sensation, although it is often referred to as contrast: it is rather a matter of incompatibility in consciousness. There is no similar opposition of sensory qualities.

It was said in § 26 that tones are intrinsically harmonious, colours intrinsically antagonistic. This statement means that the nervous processes underlying visual sensation are antagonistic, and that colours themselves offset one another, show one another up; whereas the nervous processes aroused by the sympathetic vibration of the basilar fibres are confluent, synergic, and tones themselves show a tendency to blend or fuse with one another. It must, however, be understood that the antagonism of visual sensations is not at all the same thing as the incompatibility of pleasantness and unpleasantness: for, first, the antagonistic qualities of black and white are actually connected by the series of greys, due to the admixture of the central grey; and we might, with similar aid from the centre, obtain series of sense-qualities connecting *R* with *G*, and *B* with *Y*. Pleasantness, on the other hand, is con-

sciously at odds with unpleasantness; the opposition of the two processes belongs to the essence of them as experienced. And secondly, there is no such thing as affective contrast, in the strict meaning of the term; the pleasure of convalescence is not enhanced by the unpleasantness of past suffering, as red is enhanced by green. Convalescent comfort is itself the opposite, the conscious antithesis, of the discomfort of sickness; but it is not influenced by that discomfort.

It is true, however, that we often speak loosely of contrast when we are referring to affective opposition. An ordinary man, seen by the side of a dwarf, looks unusually large; the same man, seen by the side of a giant, looks unusually small. We say that he looks large and small by contrast. The fact is that we feel a sort of contemptuous pity for the dwarf, and a surprised admiration for the man beside him; and again, a contempt for the man and an admiration for the giant. What we have laid to the account of a spatial contrast is really due to affective opposition. —

It is worth noting that this affective opposition is reflected in certain of the cutaneous perceptions that in ordinary speech are termed feelings (§ 68). We oppose warmth and cold,—not as sensory qualities, for they belong to different senses; but as pleasant and unpleasant. On the whole and in general, warm and smooth and soft things are pleasant to the touch, and cold and rough and hard things are unpleasant. Indeed, whenever we find in consciousness an opposition of this sort, we may be sure that it is an opposition due to the presence of affective processes alongside of the sensations. And in so far as we oppose warmth to cold, smoothness to roughness, for affective reasons, in so far there is some justification for giving these processes the name of feelings.

*Other Distinguishing Characters of Affection.*—We have distinguished affection from sensation on the negative ground of lack of clearness, and on the positive ground of qualitative opposition. It has been urged, further, that sensations are the objective and affections the subjective elements of consciousness. No one, however, has found a satisfactory psychological definition of these terms. We may, perhaps, call sensations objective in the sense

that they can stand alone in consciousness, independently of affection; and we may call affections subjective in the sense that they never appear alone, but always and of necessity as the companions of sensation. But this is itself a disputed point. Again, it is urged that all sensations may be localised in space, while affection is not localisable. But it is argued, on the other side, that tones and odours sometimes resist all our efforts to place them; while the pleasantness of a sweet taste, and the unpleasantness of an organic pain, are localised along with the taste and the pain themselves. Yet again, it is urged that the sensation is normally more intensive than the image, the perception than the idea; but that the affection which accompanies the idea is normally more intensive than that which accompanies the perception. But, if one psychologist informs us that "only the very highest degrees of sensory agreeableness and sensory disagreeableness are now able to overpower the 'higher' feelings," another asserts, just as positively, that "ideal pains and pleasures are not comparable in mere intensity with sensuous pains and pleasures." Contradiction could hardly be flatter!

In all these controversies, the writer leans to the affirmative side, the side which affirms a difference between affection and sensation. He does not believe, for instance, that a purely affective process may enter consciousness alone, as the herald of a coming sensory process, or that it may lag behind in consciousness alone, after its sensory companions have disappeared, — although both these statements are freely made. He finds a sort of flimsiness or softness or yieldingness in the texture of pleasantness and unpleasantness; their quality is like that of certain organic sensations, but they are less hard, less stable, less self-supporting. This difference, which is difficult to express in words, is probably connected with the presence or absence of the attribute of clearness; but there is no reason why it should not be termed a difference of objective and subjective. Again, the writer believes that affections are always coextensive with consciousness, diffused over all the sensory contents present at the time; and that, if the pleasantness of a taste is localised in the mouth, that is simply because consciousness itself, under the experimental conditions, has been

narrowed down to a taste-consciousness. Finally, there seems to be no doubt that, in the adult human mind, the ideal feelings are usually stronger than the sensuous. I fall down on a slippery path, and hurt myself; but my first thought is "How stupid of me to slip!" I sit in a draughty concert hall with the certainty of a neuralgia; but I am afraid of making myself ridiculous, and so I remain in my chair. It is a raw evening, and I have a little cold; but I go to see my friend, because I do not want to disappoint him. Were it worth while, illustrations of this kind could be multiplied a hundredfold. It is not worth while, because the question at issue cannot be decided by casual observation. Divergence of opinion is inevitable, until the experimental method has been brought to bear, systematically, upon the problems of feeling. In the meantime, we must be content to mark off affection from sensation by the two salient characters described in the text.

*The Question of Mixed Feelings.*—It would seem that, if pleasantness and unpleasantness are opposite and incompatible, they cannot coexist in the same consciousness,—that we cannot feel pleased and feel displeased at one and the same moment. A consciousness, however, is a very complicated affair; it is made up of a large number of elementary processes; and there is no doubt that the nervous system may be exposed, in different quarters, to stimuli some of which, if felt by themselves, would be felt pleasantly and some of which, if felt alone, would be felt unpleasantly. Hence it becomes a question of fact whether these various stimuli, acting together at the same time, give rise to a single resultant affection, either pleasant or unpleasant; or whether every stimulus sets up its own localised affection, so that consciousness may be a mosaic of separate pleasantnesses and unpleasantnesses.

Language favours the second alternative. We go back to school after the holidays with mixed feelings; we visit our old home, after a long absence, with mixed feelings; there is, indeed, hardly anything that we may not look upon, or look back or forward to, with mixed feelings. Juliet tells us that parting is sweet sorrow, a pleasant unpleasantness; and Tennyson's Geraint watches the

mowers, whose dinner he has just eaten, with humorous ruth, that is, with a pleasantly unpleasant feeling. There is no pleasure, we are told, without its alloy of pain; there is no despair so dark that it is not lightened by a ray of hope. Popular psychology makes no question about mixed feelings; and a psychologist of standing writes that "almost all mental states which are marked by strong feeling in the case of developed minds are mixed feelings."

On the other hand we know that a single trifling annoyance may colour our whole mood. When Othello behaves unkindly to Desdemona, she excuses him on the ground that he is worried by affairs of state; "for let our finger ache," she says, "and it induces our other healthful members ev'n to that sense of pain." We know, too, that if we are in a particularly good temper we take everything good-temperedly; we may even ask pardon of the man who has trodden on our corns. And there is really no proof that the pleasantness and unpleasantness of the mixed feeling are strictly coincident: Juliet may be alternately glad and sorry; sorry now to part from Romeo, but glad the next moment that he is there, as her lover, to be parted from, and glad a moment after in the thought of seeing him again. How quickly the pendulum of feeling may swing we see in the case of the child, who is crying bitterly at its hurt and then, within a few seconds, is smiling over a lump of sugar.

The final appeal lies, of course, to experiment. Unfortunately, but few experiments have so far been made, and the results of these few are not wholly clear. It is safe to say, however, that the tendency of the experimental evidence is decidedly negative; mixed feelings are, in the laboratory, the exception and not the rule; and the exceptional cases are themselves not above suspicion. The writer has never found, in his own experience, a definite and unmistakable case of mixed feeling.

§ 70. **Other Views of Affection.** — Affection, as we have described it, is an elementary mental process that is both like and unlike sensation. The resemblance is so great that the two processes are evidently derived from a com-



mon mental ancestor; the difference is so great that we have no choice but to rank affection, in human psychology, as a second type of mental element, distinct from sensation.

There are, however, many psychologists who would refuse to accept these statements. Some look upon affection as an attribute of sensation, on a level with quality or intensity; they speak of the feeling-tone or the affective tone of sensation, and not of a separate affective process. Others identify affection with a certain kind of sensation; pleasantness, they say, is a diffuse sensation of tickling, or a weak sensation of lust; unpleasantness is a low intensity of cutaneous or organic pain. Others, again, think that the same processes may appear sometimes as organic sensations and sometimes as affections, according as they are isolated in consciousness, analysed out by attention, or are given in a mixed medley of unanalysed experience.

The first view, that affection is an attribute of sensation, is easily disposed of. For affection has attributes of its own, — quality, intensity, duration; whereas the attributes of sensation are ultimate phases of an elementary mental process, and cannot by any effort of abstraction be factorised into simpler components. Moreover, if any single attribute of sensation is reduced to zero, the sensation disappears: a sensation that has no quality, or no intensity, or no duration, is not a sensation at all; it is nothing. But a sensation may be non-affective, perfectly indifferent, and still be far removed from disappearance. This view, then, may be dismissed from consideration.

Nor does the second view seem to be more tenable. All these sensations, tickling and lust and pain, may become clear, may be made the object of attention; indeed, they



are, so to say, naturally clear, precisely the sort of sensations that we are obliged to attend to. But we cannot attend to affection. Again, all three sensations have their own quality as sensations. We have not fully described tickling or lust when we have dubbed it pleasant; we have not fully described pain when we have dubbed it unpleasant. Tickling has a ticklish quality, that is peculiar to it as sensation; lust has a specific quality, which differentiates it from tickling; pain has a peculiar quality of itch or ache or thrill. An experience which is both ticklish and pleasant, or is both itchy and unpleasant, cannot be identified with pleasantness or unpleasantness; it is something more. And finally, tickling and lust may, with change of circumstances, be either pleasant or unpleasant, and the same thing holds of pain; the scratching of an irritated area of the skin may be at once painful and distinctly pleasant. While, however, these arguments appear unanswerable, it is nevertheless true that the theory which they oppose is held by a large number of modern psychologists.

The third view tries to reconcile the belief that affection is a second form of elementary process with the belief that it is only a certain sort of sensation. We have, it says, various obscure and confused experiences which, ordinarily, we take as they come, without asking what they are made up of. So long as we do this, the experiences present themselves as pleasantness or unpleasantness; but if we scrutinise them, and analyse them into their elements, then they reveal themselves as complexes of organic sensation. The reply is, surely, that experiences which may be analysed into organic sensations are complexes of organic sensations, and nothing more or less; but that, if an experience is pleasant or unpleasant, then the pleasantness or unpleas-

antness remains, no matter how many organic sensations are found along with it. Unless affection is organic sensation, — and we have declined to admit that affection is a sensation of any kind, — the third view is untenable.

It is impossible here to discuss or even to mention all the views that have been held by psychologists concerning the nature of affective experience. Affection has been described, for instance, as a relation, whether between sensations or between a particular sensation and all the rest of consciousness. There is some ground for both opinions. Certain combinations of tones are pleasing, certain others displeasing; certain architectural proportions are beautiful, certain others are ugly. These facts tell in favour of the first theory. Again, a sensation that now enters consciousness enters into relation with all the contents of consciousness, and must, so to say, make its terms with those contents. If it fits in easily among them, it will probably be pleasant; if it disturbs or suppresses them, it will probably be unpleasant. All this tells in favour of the second theory. Nevertheless, both theories alike are to be rejected. Against the first we must urge that affection is not always dependent upon the relation between sensations, but may attach to a single sensation; and, besides, that affection, even if dependent upon sense-relations, need not on that account be itself a relation. Against the second we must urge, in the same way, that the fitting-in of the new sensation, or its reverse, is purely a matter of the behaviour of sensation; it is not necessarily accompanied by affection; still less is it to be identified with affection.

Affection has also been described in terms of mental attitude. It has been defined as such an attitude: affective experience, we are told, is made up of one's own attitudes, and sensory experience of the impressions that one receives: and it has been defined as a character of mental process that depends upon and represents one's personal attitude. In its cruder forms, this theory implies the existence of that permanent mind, that mind-substance or mind-animal, which we rejected in § 3. But even at the best we

may well enquire whether it does not put the cart before the horse. Does feeling represent our mental attitude, or is our mental attitude the expression of feeling?

§ 71. **The Methods of Investigating Affection.** — There are two chief difficulties in the way of an experimental treatment of the affective processes. We cannot attend to pleasantness or unpleasantness; and we can describe our affective experience only in a roundabout way. The first of these difficulties needs no further discussion; we have seen that affections lack the attribute of clearness. The second difficulty arises from the fact that spoken language is a language not of feeling but of idea. If I say 'I am very angry,' you know that I am angry; I have given you the idea of my anger; but I have, after all, merely indicated my feeling, and not described it. And even if I should attempt a detailed description, my account — so far as it referred to the pleasantness or unpleasantness of the anger — would still be an account at second hand; I should be obliged to translate my affection into an idea of affection.

There is, it is true, a language of feeling: the language of exclamation and gesture. But we have learned, in the course of civilisation, to repress our emotions; we rarely use this language; if on occasion we wish to do so, we are apt to make ourselves ridiculous; and the language itself is but little developed in comparison with speech.

Partly on account of these difficulties, and partly for other and historical reasons, experimental psychology has, until recently, neglected the study of affection. The problems that were at first attacked in the psychological laboratory were suggested by physics and physiology and astronomy: the problems of mental measurement (§ 63), of

the number and nature of the sensory qualities and of their relation to the organs of sense (§§ 14 ff.), and of the duration of mental processes. Feeling had no place in the programme. Now, however, that psychology has gone far enough to experiment on its own behalf, without suggestion from its neighbours, the study of feeling has begun. There are two experimental methods at present in use: the method of impression and the method of expression.

(1) The method of impression has taken various forms, the most promising of which is the method of paired comparisons. In this, a series of similar stimuli is laid out, and the stimuli are presented to the observer two at a time; care is taken that every member of the series is paired with every other member. We may have, for instance, a series of squares of differently coloured paper, numbered in order 1 to 50. We cut two square windows in a sheet of neutral grey cardboard, and show the colours in these windows; the series of observations is so arranged that colour 1 shall be shown along with 2, 3, 4, . . . up to 50; colour 2 with 3, 4, 5, . . .; and so on. In a first experiment, the observer may be asked, as the successive pairs are exhibited: Which of the two colours is the more pleasant? In the next experiment: Which of the two is the more unpleasant? And the series may be repeated as often as seems necessary. The introspective task is extremely simple: the observer has merely to be passive, to let himself go, to allow the stimuli to take affective possession of him. He need not even speak; all that he has to do is to point towards the window which contains the more pleasant or the more unpleasant colour; and the experimenter then records his choice.

(1)  
Imp

At the end of an experiment, every colour has received a

certain number of choices, proportional to its affective value; a very agreeable or very disagreeable colour will have been preferred many times over, a colour that is hardly more than indifferent will have been chosen but rarely. If, now, the names or numbers of the colours are arranged in order, 1 to 50, along a base line, and the number of preferences is indicated in every case by the length of a vertical line erected upon this base, then the smooth curve which joins the tops of the verticals may be termed the affective curve for the particular observer; it is a curve whose course directly expresses his affective response to colour stimuli.

The method may be put to various uses: here is an illustration. We have argued, in § 69, that pleasantness and unpleasantness are opposite and incompatible. If we have recourse to the method of paired comparisons, we can prove that they are opposite. Experiments made with series of coloured papers, series of musical tones, and series of rhythms (rates of metronome beats) give affective curves for pleasantness that are just the reverse of the same observers' affective curves for unpleasantness: stimuli that receive a large number of choices in the experiment on pleasantness receive a correspondingly small number in the experiment on unpleasantness. To prove a thing like this may look like proving the obvious. But, in fact, nobody knew for certain, until these experiments had been made, that pleasantness and unpleasantness were opposite; psychologists might believe, but they did not know. And besides, things that look obvious are oftentimes, in science, the things that very particularly call for proof.

The method may also be used to measure the individual differences in affective response to stimuli. We say that there is no disputing about tastes; and we tend to think, in general, that sensations are experienced in the same way by all normal persons, but that affections are experienced differently, individually, personally. In reality, sensations are less stable and affections are more stable than we suppose. For sensations are changed and shifted by the

varying conditions of adaptation, contrast, attention; while the affective curves of a number of different observers are sufficiently alike to show that, under the same circumstances, all normal persons react affectively in very much the same way.

The method of impression can do us further service. The simple introspective task which it sets is repeated, over and over again; the introspective experience acquired during a series is cumulative, all of the same kind. Hence the observer is able, in the intervals between successive series, to make a full report upon the affective consciousness: he can describe the course of the sense-feeling, take note of anything like a mixed feeling, state whether the agreeableness or disagreeableness of the stimuli was always of the same kind or showed differences of quality, and so on. It is, indeed, to this method that we must mainly look for a settlement of the vexed questions of affective psychology. The work is laborious, and consumes a great deal of time. But the method offers the advantage of a twofold control: an external control by the affective curve, the objective record of the distribution of preferences; and an internal or subjective control by the accompanying introspection.

(2) The method of expression seeks to record the bodily changes which accompany the passage of an affection through consciousness. Just as we express emotion by smiling or frowning, by laughter or tears, by clapping the hands or shrugging the shoulders, so do we express the simplest affective experience by a change of various bodily functions. Tests have been made of pulse, respiration, the volume of a limb, involuntary movement, muscular strength, and the response of the bodily tissues to the electric current.



Physiology has long been in possession of instruments that furnish the records required, and psychology has borrowed these instruments and has adapted them to its own purpose. Take pulse, for instance. We know that the pulse can easily be felt in the wrist, over the radial artery. Now suppose that a small tin funnel is covered, at the wide end, by thin rubber sheeting; and that the sheeting is laid over the artery, and the funnel tied to the wrist. At every beat of the pulse, the rubber will be lifted, and a puff of air will be sent out from the small end of the funnel. Connect this end, by a piece of stiff-walled rubber tubing, to the small end of another funnel, whose wide end is similarly covered with rubber sheeting. Hinge to the lip of the second funnel a light splinter of bamboo; let the splinter lie across the rubber sheeting,

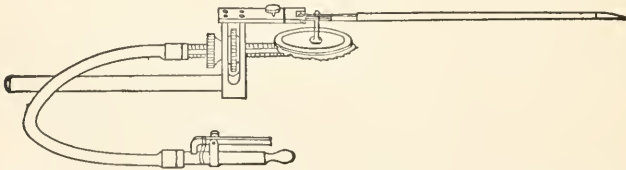

FIG. 29. Marey tambour (rubber-faced funnel) with writing lever, rubber tubing, and air-cock. The tubing is continued from the air-cock to the tambour on the wrist.

and let it rest in the middle on a tiny disc of cork cemented to the rubber. Whenever a puff of air is sent from the first funnel, by the pulse beat, the cork disc of the second funnel will be lifted, and the splinter will rise with it. Now take a piece of glass, that has been smoked over a gas flame, and set it up, in the vertical position, so that the free end of the splinter rests lightly against it. It is clear that, as the pulse rises and falls, the bamboo point will rise and fall on the glass, and will trace a clear line in the soot. And if the glass be drawn slowly forward at a constant rate, a pulse-curve will be traced which shows the rate and the height of the successive beats. Then the glass may be sprayed with varnish, and we have a permanent pulse record.

This is a rough indication of what is called the graphic method. In practice, the instruments are much more complicated and in-



genious. The bodily change may be transmitted to the bamboo stylus not by air but by a system of rigid levers, or by the electric current. And in place of the glass plate we use a kymograph, a brass drum covered with smoked paper, which may be revolved at varying rates. To ensure accuracy in the interpretation of the curve, time-markers are employed, which trace a time curve (in seconds, or half seconds, or fifths of a second, or even in much smaller units) below the curve of pulse or breathing. In principle, however, the tin funnels and the smoked glass plate represent the method.

The instrument which registers the height and rate of pulse is termed the sphygmograph. Similar instruments, tied round the chest or abdomen, register the course of thoracic and abdominal breathing: they are called pneumographs. Volume is registered by the plethysmograph, a large glass jar, partly filled with warm water, in which the hand and forearm of the subject are placed. A glass tubule leads off from the jar,

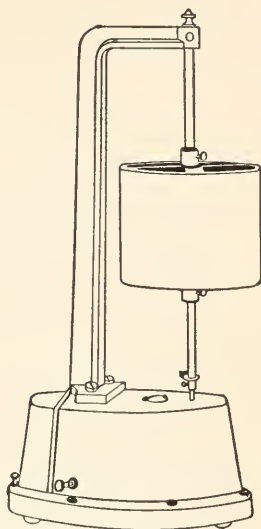

FIG. 30. Clockwork Kymograph.

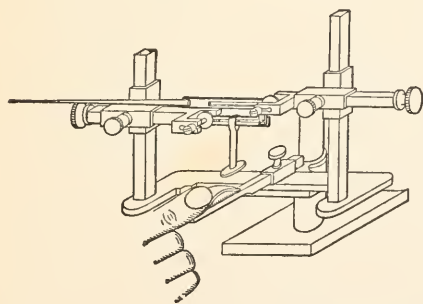

FIG. 31. Franck's Volumetric Sphygmograph (mechanical transmission by means of a system of levers).

by way of rubber tubing, to the recording funnel or tambour; as the arm swells, the water in the jar rises, the air above it is compressed, and the stylus is thrown up. Involuntary movement is registered by the automograph, a form of the planchette or ouija-board which still figures

largely in spiritistic seances. A board is slung from the ceiling, so that it lies horizontally just over the surface of a table ; a pointed

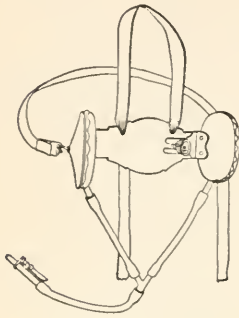

FIG. 32. Pneumograph.

glass rod stands vertically in a hole pierced at its forward end. On the table, under the point of the rod, is spread a sheet of smoked paper. If the arm is laid carefully on the board, and left to itself, the glass point traces on the paper the record of its involuntary movements. Muscular strength is registered by the dynamograph or ergograph : in the former, the hand grips a steel spring, the compression of which sends a puff of air through the transmitting system to the stylus ; in the latter, the finger pulls repeatedly against a weight or a spring, and the cord upon which it pulls carries a stylus which writes directly upon the kymographic surface. Lastly, in order to measure what has been termed the psychogalvanic reflex, two electrodes, which are connected with a battery giving a constant current and with a sensitive galvanometer, are applied to the hands or to other cutaneous surfaces ; an affective stimulus is then presented to the subject, and the resulting deflection of the needle of the galvanometer is recorded.

In every case, the procedure of the experiments is the same. First of all, a normal reading is taken from the instruments : the experimenter assures himself that the subject is in an indifferent frame of mind, and without applying any stimulus takes a curve of pulse, breathing, or volume ; or allows the stylus of the automatograph to record the involuntary tremor of the arm ; or obtains an ergographic record ; or notes the constant position of the galvanometer needle. Then he applies some agreeable or disagreeable stimulus, and the record is made while the sense-feeling

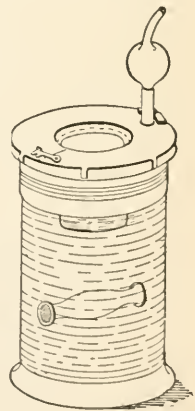

FIG. 33. Franck's Plethysmograph.

is running its course. The experiments are repeated again and again; and finally the experimenter tries to discover, from his tracings and notes, the exact correlation between affective quality and the bodily change which expresses it.

The method of expression was introduced into experimental psychology with great expectations; and the results of the first experiments seemed clear and definite. All the

bodily functions were heightened and strengthened in pleasure, and all were weakened and depressed in unpleas-

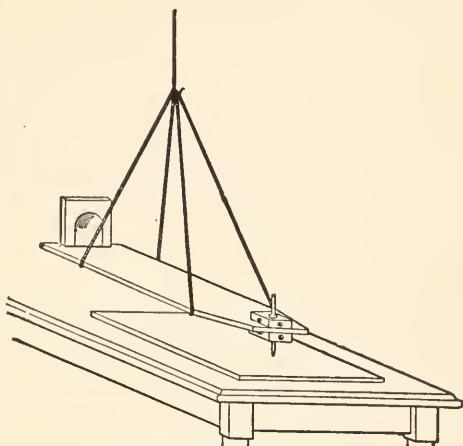

FIG. 34. Automatograph.

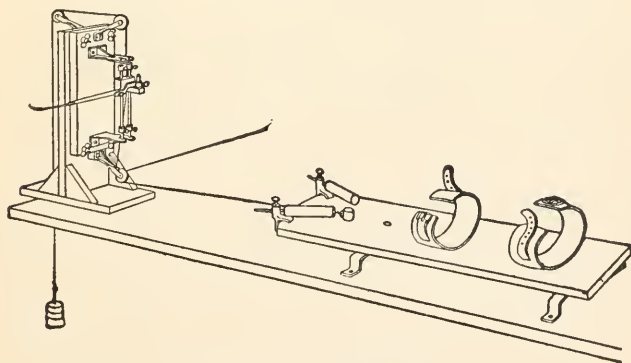

FIG. 35. Mosso's Ergograph.

ant states of mind. A leading psychologist compared the method to 'an extraordinarily delicate chemical rea-

gent' for the detection of pleasantness and unpleasantness. Very soon, however, these dreams were dispelled. The

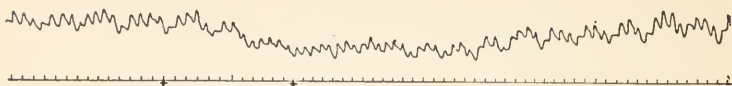

FIG. 36. Part of a tracing obtained with the Franck plethysmograph, one-third actual size. The small waves indicate pulse, the large waves breathing. Change of volume is indicated by the varying height, above the time-line, of the entire tracing. An unpleasant stimulus was applied at the moment marked by the left-hand cross, and removed at that marked by the right-hand cross. The unit of the time-line is 1 sec.

changes in the curves are not correlated, unambiguously, with changes of affective experience: they depend in part upon purely physiological factors, and in part upon other psychological processes, — for instance, upon attention.

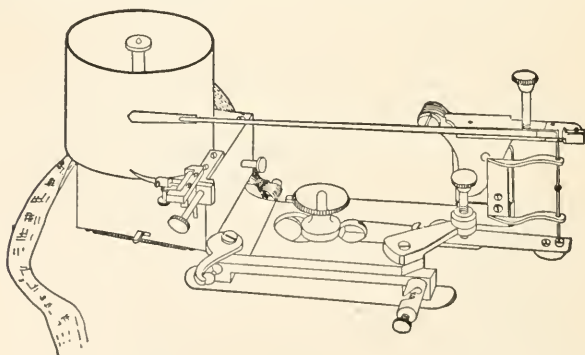

FIG. 37. Von Frey's Sphygmograph. The entire apparatus is bound upon the wrist, the button at the extreme right resting on the artery. The movements of the writing-lever are recorded on a very small, light drum, driven by a clockwork which is housed in the square box to the left. The clockwork also actuates a time-marker, shown in the Fig. at the lower edge of the drum.

Indeed, the simple application of even a weak stimulus appears to throw the whole body, as it were, into reverberation; you cannot show the observer a wall-paper pattern without by that very fact disturbing his respiration and

circulation. If the automatograph proves that the organism involuntarily expands, reaches out, in pleasure, and involuntarily withdraws, shrinks back, from the disagreeable, it proves also that you reach out when you think of a house across the street, and shrink back when you think of the person behind you. There may be a general rule that pleasantness goes with quick and shallow breathing and slowed pulse, unpleasantness with slow and deep breathing and quickened pulse; such an antagonism would well express the opposition of the affective qualities. But there can be no doubt that these changes in pulse and respiration may be otherwise occasioned, and that the appearance of the affective correlation depends upon conditions that are, as yet, only imperfectly understood. Pulse, for instance, has been found to quicken when the stimulus is a pleasant taste, and to slow when it is a pleasant tone or colour; and breathing appears to vary in its behaviour with different individuals.

So far, therefore, we have gained little from the method except a number of divergent results, and the conviction that, before these results can be psychologically interpreted, we must know a great deal more than we do of the bodily functions involved.

It has recently been suggested that the methods of impression and expression might profitably be combined, the registration of physical expression serving as an objective check upon the observer's introspective report, and the introspection in its turn being used for the interpretation of the objective record. It is, of course, feasible to register the course of pulse or breathing during an entire series of experiments by the method of paired comparisons. But the registration would hardly be worth while, unless the introspective task set to the observer were greatly complicated; and then we should lose one of the chief advantages of the method.

It therefore seems best to continue work by the method in its present form, and to wait patiently for the time when increased knowledge shall give us the required understanding of the physiological processes.

It may be added that the psychogalvanic method, though in principle it dates from 1888, has only within a year or two been brought into the psychological laboratory. Hence we can hardly judge of its merit or promise as a means of affective investigation, though the indications are that it will offer the same difficulties as the other forms of the expressive method.

§ 72. **The Tridimensional Theory of Feeling.** — In 1896, Wundt propounded a theory of feeling that differs radically from the view taken in this book.

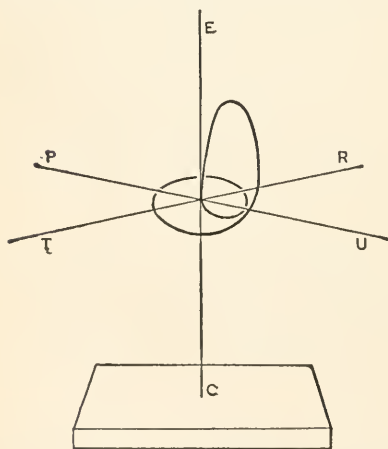

FIG. 38. Diagram representing the course of a typical sense-feeling, according to Wundt's theory. The feeling sets in as a mixture of excitement and unpleasantness, to which tension is soon added. It then drops into the region of pleasantness and calm, takes on a tinge of relaxation, and so ends at the indifference-point from which it started.

Pleasantness and unpleasantness, he declared, are not simple affective qualities, but general names for a very large number of different qualities. And even so, the terms pleasant and unpleasant are not adequate as introspective descriptions of our affective experience. That experience is, so to say, tridimensional. Feeling moves, first, between the opposite poles of pleasantness and unpleasantness; secondly, between excitement and depression; and thirdly, between

tension and relaxation. Excitement and depression, tension and relaxation are, again, general names for a very large number of ultimately different affections. Indeed, the full list of affective qualities, distinguishable under the six headings, is far longer than the total list of sensations.

This theory has found many adherents, and has naturally also aroused a great deal of controversy. It must evidently be met, if our own two-quality view is to be maintained. Let us see, then, what is to be said for and against it.

The first thing to ask about a scientific theory is whether it is logically constructed. Wundt assumes three categories or dimensions of feeling. Pleasantness and unpleasantness depend, he says, upon the intensity of the stimuli that affect us: a moderate amount of stimulation is pleasant, while too much or too little is unpleasant. Excitement and depression depend, similarly, upon the quality of stimulus. Finally, tension and relaxation depend upon time, upon the temporal aspects of stimulus; as we wait and expect, we become tense, and when the event happens, we relax. In other words, our sensory experience varies in degree, varies in kind, and varies in time: and every such variation corresponds to a distinct category of affection. But now the critical question arises: Does not our sensory experience also vary in space? Do not spatial perceptions and spatial ideas bulk as large in consciousness as intensive or qualitative or spatial? Is not the world of space as native and as important to us as the world of time? And if this is the case, as it undoubtedly is, then Wundt's theory is illogical. There should be four affective dimensions, not three; and the fourth sort of



feelings should depend upon the spatial aspects of stimulus. The objection is, indeed, more than logical; it is also psychological; for a view of feeling which ignores the part played by space in our mental life must be psychologically inadequate.

Now consider a second point. Pleasantness and unpleasantness are opposite, in name and in nature. But relaxation is hardly, in the same way, the opposite of tension; relaxation is rather the minimum, the zero point, of tension. And what is the opposite of excitement? Sometimes Wundt says depression; sometimes calm; sometimes arrest. But these three feelings are surely different: to feel depressed is not the same thing as to feel calmed down, and to feel calmed down is not the same thing as to feel checked or baffled. Logically, the pairs excitement-depression and tension-relaxation are not of the same order as the pair pleasantness-unpleasantness. And again the objection is more than logical; for the direct opposition that is felt in pleasantness-unpleasantness cannot be felt in the other two cases.

It appears, then, that the new theory is not logically constructed. More than that, its logical weaknesses point, pretty clearly, to psychological defects. Psychology, however, may now speak for itself: and the first thing it has to say is this,—that excitement and depression, tension and relaxation, are never simple, elementary processes; they are, on the contrary, experiences of some complexity; and they invariably contain organic (especially kinaesthetic) sensations. On the sensory side, they represent — to put it roughly — different muscular attitudes; on the affective side, they may be either pleasant or unpleasant. Pleasurable excitement may be the opposite of depressed mel-

ancholy, or as eager expectancy the opposite of baffled failure; anxious excitement is the opposite of soothing calm. Similarly, a disagreeable tension is the opposite of a pleasant relaxation, but an alert preparedness is the opposite of a despondent unreadiness. The sensory differences may, by the concurrence of pleasantness-unpleasantness, be turned into affective oppositions; without pleasantness-unpleasantness there is no opposition. It is noteworthy that Wundt, in his works upon psychology, strangely neglects the organic sensations: in the present instance, the neglect has led him to transform into simple affections what are, evidently, complexes of organic sensations.

In the last resort, the theory must be put to the test of experiment. Wundt himself appeals to the results of both experimental methods. The method of expression has, we must admit, appeared in a few cases to confirm the theory. Thus, an investigation published in 1907 states the correlation found between the Wundtian categories, on the one hand, and the changes in pulse and breathing, on the other, in the following table:

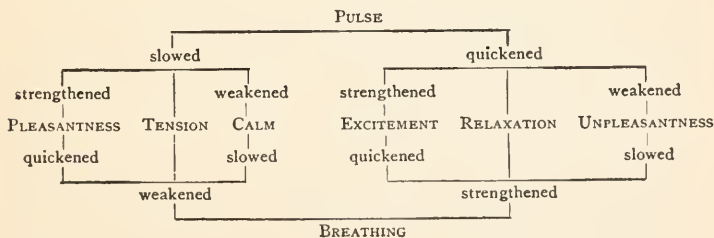

All that can be said is that results of this neat and clean-cut character are flatly negated by those of other, equally careful experimenters. We saw in § 71 that the pulse

has often been found to slow (though not to slow and strengthen) in pleasantness, but that this change varies with the sense-organ to which the stimulus is applied. We saw, too, that respiration often grows quick and shallow in pleasantness, but that its changes vary with the individual; it may, for instance, grow quick and deep, and it may grow slow and shallow! It is, plainly, too early to draw any positive inference from the results of the method of expression.

If we turn to the method of impression, we find results

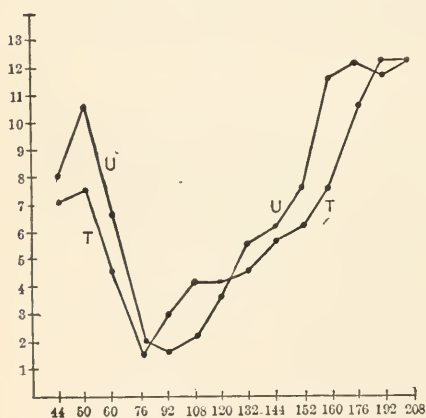

FIG. 39. Curves of tension ( $T$ ) and of unpleasantness ( $U$ ), showing that the distribution of judgments under the two headings is practically identical. The stimuli were metronome-beats, given at the rates marked along the horizontal line: 44, 50, . . . in the 1 min. The figures on the vertical line denote the number of choices. It will be seen that the least straining were also the least unpleasant stimuli (76, 92), while the most straining were also the most unpleasant (176, 192, 208).

that tell very strongly against the theory. The stimuli—colours or tones or rhythms—are presented in pairs, in the usual way, and the observers are asked to say, in successive series, which of the two is the more pleasant or unpleasant, the more exciting or depressing, the more straining or relaxing. Now, in the first place, the affective curves for excitement, depression, tension and relaxation are always

identical with the curve of pleasantness or unpleasantness; there is no special curve, no novel distribution

of preferences, corresponding to excitement, etc. Moreover, the different observers put different interpretations upon these terms: if excitement is taken to mean anxious, nervous excitement, its curve agrees with that of unpleasantness; if it is taken to mean eager, expectant excitement, its curve agrees with that of pleasantness. Similarly, if relaxation is taken to mean comfortable restfulness, its curve is that of pleasantness; if it is taken to mean a despondent giving-up, the curve is that of unpleasantness. Objectively, then, in the course of the curves, there is no evidence of new affective dimensions. And secondly, the introspective report of the observers bears out the objective testimony of the curves; excitement and depression, tension and relaxation are always described as complexes of affection (pleasantness-unpleasantness) and organic sensation. What Wundt has to appeal to is nothing more than casual observation of his own; systematic work by the method of paired comparisons has brought no support to his theory. —

So far, we have simply discussed the three main categories or dimensions of feeling. Wundt, it will be remembered, believes that each one of these dimensions comprises a very large number of ultimate affective qualities. We need concern ourselves only with pleasantness and unpleasantness: but we have still to ask whether there is just one sort of pleasantness and one of unpleasantness, or whether there are varieties of agreeableness under the common name of pleasantness, and varieties of disagreeableness under the common name of unpleasantness.

To this question no final answer can be given. The experimental evidence is both scanty and conflicting. A distinction has been drawn, for instance, between the local-

ised pleasantness of a taste, while the sweet substance is in the mouth, and the diffused pleasantness which remains after it has been swallowed. But in the former case consciousness as a whole is narrowed down to a taste-in-the-mouth (§ 69); and the pleasantness is diffused over that narrow consciousness just as, a moment later, it is diffused over a wider consciousness. Moreover, if the observer is told that he may keep the sweet substance in the mouth, as a matter of convenience, but that he is to observe his feeling as soon as he has tasted, — that he is not to hold his attention continuously upon the course of the sensation of taste, — then he reports that the pleasantness is not localised, but spread broadly over everything. And in any case a localised pleasantness need not differ in kind, in quality, from a diffused pleasantness: that difference has still to be proved. The writer has never found, in his own experience, the qualitative differences that Wundt assumes.

Wundt has on more than one occasion called attention, on behalf of his theory, to the feeling of the chord *c-e-g*. Tones, he says, usually bring out affective processes of the two dimensions pleasantness-unpleasantness and excitement-depression. Each one of the three tones *c, e, g* will therefore give rise to what we may call a quiet cheerfulness of a specific kind: there will be six affections for the three sensations. But, further, a simple affective quality may accompany a complex of sensations: so that we have three more affections for the complexes *c-e, e-g, c-g*, and yet another — probably the dominant — affection for the whole chord *c-e-g*. In sum, our affective experience of the chord is the resultant of no less than ten affective qualities. In the writer's introspection there is no evidence of this compounding; the sense-feeling entirely lacks the depth, the richness, the solidity that on the theory it ought to possess; the affective character of the chord seems to be adequately described in the terms 'slightly pleasant,' 'moderately agreeable.' —

In spite of all that can be urged against this and similar theories

of a plurality of affective qualities, the alternative position may still seem barren and repellent. We have been so carefully taught to distinguish the higher from the lower pleasures that the denial of any differences of kind, within pleasantness and within unpleasantness, may come with something of a shock. Is it really true that the pleasure of a good dinner is identical with the pleasure of a good action?

Well! remember always that affective psychology is in the trial stage, and that no one can dogmatise on the question. But in the writer's belief it is true. A good dinner and a good action seem to him to differ — not in their pleasantness: that is precisely where they are alike; but — in practically everything else. The good dinner and the good action have been set apart, in popular psychology, by reference to their one point of resemblance. And if this sounds paradoxical, remember again that popular psychology does not analyse. For it, the good dinner and the good action are both matters of feeling, of enjoyment or satisfaction: if, then, they differ, they must differ as feelings: and if they differ as feelings, they must differ as the lower pleasure differs from the higher. The conclusion follows only if you accept an uncritical use of the term feeling, and shirk the task of psychological analysis.

§ 73. **The Dependence of Affection upon Stimulus.** — When we were discussing the different kinds of sensation, we sought in every instance to connect the mental with the physical, to refer a certain attribute of sensation to a certain phase or aspect of stimulus. We found, for example, in § 15, that in general the wave-length, wave-amplitude and wave-form of light correspond to the three qualitative attributes of visual sensation, — hue, tint and chroma; although, in detail, the relation between visual stimulus and visual sensation is very far from simple. We have now to attack the same problem in regard to affection. How are pleasantness and unpleasantness related to the various aspects of stimulus?

The question has been much debated, and the answer is exceedingly difficult. If we could not discover a simple, one-to-one correlation in the case of sensation, we can hardly expect to discover it in the case of affection. For we have taken the position — not, it is true, as demonstrated beyond the reach of doubt, but at any rate as the most tenable in the present state of psychology — that there are but two qualities of affection, and that these are incompatible in consciousness. Hence the affection of any given moment is, so to say, the algebraical sum of the affections attaching to all the various sensory processes that constitute our mind at that moment. Or rather, since consciousness is not a mosaic but a system,<sup>1</sup> the affection of any given moment depends upon the interplay or concurrence of sensory processes that are combined in a certain conscious pattern; affection depends, primarily, upon the total disposition or arrangement of consciousness.

Might we not, however, secure an indifferent frame of mind in our observer, and then subject him to stimuli of different qualities, of different durations, of different degrees of intensity, — and note how he is affected by them? Truly, if the indifferent frame of mind would remain indifferent. But the action of the stimulus may be sufficient to shake consciousness out of its indifference, and to set up a wholly new, and perhaps highly affective, conscious pattern: precisely as the very slightest touch upon the kaleidoscope will throw the bits of coloured glass into a new arrangement. We have seen (§ 60) that even a weak stimulus arouses a general bodily reverberation; and in the same way a single incoming stimulus may touch off a complete consciousness, so that its own special affective value is

<sup>1</sup> Cf. the discussion of the taste-blends, p. 134 above.



masked and obscured by the affective resultant of the system.

Nevertheless, so much seems clear: that affection depends less upon the several and separate attributes of stimulus than upon their combination. We noted in § 12 the existence of sensory attributes of the second order; and we gave as illustration the aggressiveness or insistence or importunity of sensation that results from the connection of clearness with intensity, or clearness with quality, or what not. It is this secondary attribute of aggressiveness that appears to determine the arousal of affection; and the higher degrees of it appear to arouse unpleasantness, the lower degrees pleasantness. We can hardly with confidence say more; and in saying this we must remember that affection is extremely liable to adaptation, so that the insistence of a particular stimulus may quickly disappear.

Wundt connects the dimension of pleasantness-unpleasantness with the intensity of our experience (§ 72); and it must be admitted that intensity is one of the commonest and one of the most dominant factors in what we have termed insistence. But there are qualities that are similarly aggressive: bitter, for instance, or tickling. It is hardly possible to make a strict comparison between the intensities of different qualities; but it will probably be agreed that bitter is unpleasant at an intensity at which sweet is still indifferent, and tickling unpleasant at an intensity at which pressure is indifferent. And in general, sensations of taste and smell seem to be more insistent, and are certainly more affective, than sensations of sight and hearing.

There is some little evidence that affection, on its intensive side, obeys Weber's Law (§ 66). While the lower degrees of insistence are pleasant, and the higher degrees unpleasant, a progressive increase of insistence within either region of the scale will give us, of course, an increasing pleasantness or an increasing

unpleasantness. Now we have seen that intensity of stimulus is oftentimes the dominant factor in insistence. Where this is the case, it seems probable that, if the intensity of affection is to progress by equal steps or intervals, then the intensity of stimulus must increase by relatively equal amounts. At any rate, it is true as a general rule that what gives us pleasure or displeasure is roughly proportional to our income, our age and status, our ambition, our standard of comfort. If I am starting a library with a hundred volumes, and a single book is given me, I am as pleased — other things being equal — as I should be by the addition of ten volumes to a library of a thousand. The stamp which completes the set in the schoolboy's album gives him as much pleasure as the acquisition of the last farm which completes the ring-fence gives the wealthy landed proprietor. All these things sadly need experimental confirmation; but there seems no reason why affective intensity should not, and there seems to be some evidence that in fact it does, follow the same law as the intensity of sensation.

§ 74. **The Bodily Conditions of Affection.** — If we know but little of the affective processes themselves, we know still less about their bodily conditions. The suggestions that follow are, therefore, entirely hypothetical.

It is natural to suppose that the material of consciousness, the stuff out of which mind is made, was originally homogeneous, all of a piece: so that sensations and affections are simply different species of the same genus. We have seen, indeed, that there is positive evidence for this view; there are fundamental resemblances between the two elementary processes, which point to their derivation from a common mental ancestor. If, then, we adopt it as a working hypothesis, the affections appear — not exactly as undeveloped sensations, for an undeveloped sensation is still a sensation — but at any rate as mental processes of the same general kind as sensations, and as mental pro-

cesses that might, in more favourable circumstances, have developed into sensations. The writer hazards the guess that the peripheral organs of affection are the free afferent nerve-endings—what are ordinarily called the free sensory nerve-endings—distributed through the various tissues of the body; and he takes these free endings to represent a lower level of organic development than the specialised receptive organs, or organs of sense. Had mental development been carried further, pleasantness and unpleasantness might have become sensations: in all likelihood would have been differentiated, each of them, into a number of sensory qualities. Had our physical evolution been carried further, we might have had a corresponding increase in the number of internal sense-organs.

It was said in § 42 that the free nerve-endings of the epidermis are probably to be regarded as the terminal organs of pain. If this hypothesis is correct, we might perhaps assume, as some psychologists do, that there is a close genetic kinship between the sensation of pain and unpleasurable affection. Pain would then appear as a specialised sensory derivative from unpleasantness, and would still retain an end-organ of the affective type.

On the other hand, we have to remember that the cutaneous pain-sense has three qualities, itch, prick, and pain proper, and that these qualities are by no means necessarily unpleasant. Intensive pains are unpleasant; but so are bitter tastes, and so are rank and foul and nauseous odours. Besides, we know very little about the cutaneous sense-organs, aside from pressure, and we know nothing at all of the organs of the dull, deep-seated pain that seems to be different from the bright and thrilling pain at the surface of the body (§§ 41, 56). The pains proceeding from muscular tissue and from the peritoneum probably have specialised organs. On the whole, therefore, it is best to leave pain out of account. If the free endings of the epidermis are not organs of pain, the physiological evidence for the connection of pain with

unpleasantness falls to the ground. If they are, it is still possible that their exposed position and consequent liability to injury allow them to function as sense-organs, while they are replaced in the interior of the body by more highly specialised structures; or it is possible that they have become adapted, in some unknown way, to the reception of sensory stimuli. No opinion can be more than a conjecture.

This theory of the bodily conditions of affection explains, first, the lack of the attribute of clearness. Affective processes are processes whose development has been arrested; they have not attained, and now they never can attain, to clear consciousness. Affective experience is the obscure, indiscriminable correlate of a medley of widely diffused nervous excitations. The theory explains, secondly, the movement of affective processes between opposites; for the nervous excitations will vary with the tone of the bodily systems in which they are set up, and that tone can itself vary only in two opposite ways. It explains, thirdly, the introspective resemblance of affection to certain organic sensations; genetically, the two sets of processes are near akin, and it is natural that they should be alike in experience. And it explains, fourthly, the apathy or lack of feeling that comes with visceral anaesthesia (§ 56); for if the specialised nerve-terminals, the sense-organs of the viscera are paralysed, it is to be expected that the unspecialised free endings, occurring in the same tissues, should share their fate. Finally, the theory is non-committal on the questions of mixed feeling and of a differentiation of qualities within pleasantness-unpleasantness. It thus serves well enough for the present state of our psychological knowledge. It is, nevertheless, simply a guess.

Many other guesses have been made with regard to the bodily conditions of affection, both peripheral and central. Under the latter heading it has been conjectured, for instance, that the affections are indices of the state of nutrition of the cerebral cortex; that they are symptoms of the readiness of motor discharge; and that they are connected with the activity of a special cortical centre. Each one of these hypotheses has a certain plausibility, but none is within measurable distance of proof. —

When physiology leaves us in this perplexity, it is but natural that we should make appeal to the wider science of biology. Can biology help us to a psychology of feeling? Well! a great deal has been written about the biological significance of pleasantness and unpleasantness. The pleasurable, we are told, corresponds to the useful, and the disagreeable to the harmful; pleasant experiences are good and unpleasant experiences are bad for the organism. And this means that pleasantness is felt when the activity of a bodily organ is in balance, outgo of energy equalling intake of nourishment; and that unpleasantness is felt when the organ is out of balance, either overworked or overnourished. But, first, the general law of correlation, pleasant-useful and unpleasant-harmful, cannot be made out: there are gross and obvious exceptions. Moreover, if it could be made out, it would not aid our psychology; for useful and harmful mean nothing until they are translated into psychological and physiological terms; and as soon as the translation has been made, we can dispense with biology altogether. Secondly, the theories of organic balance are as conjectural as the rest, and are very difficult to apply in detail. It is hardly worth while, therefore, to devote further space to biological considerations.

#### References for Further Reading

§§ 68-74. Wundt's tridimensional theory is set forth in his *Outlines of Psychology*, 1907; or, at greater length, in the *Grundzüge der physiologischen Psychologie*, ii., 1902, 263. For a theory which identifies affection with sensation, see C. Stumpf, *Ueber Gefühlsempfindungen*, in the *Zeitschrift f. Psychologie*, xlv., 1906, 1. A critique of these theories, and a discussion of the differences between sensation and affection, will

be found in the author's *Lectures on the Elementary Psychology of Feeling and Attention*, 1908, Lectures II.-IV.

For the method of impression, see S. P. Hayes, *A Study of the Affective Qualities*, in *American Journal of Psychology*, xvii., 1906, 358. For the method of expression, see J. R. Angell and H. B. Thompson, *A Study of the Relations between Certain Organic Processes and Consciousness*, in *Psychological Review*, vi., 1899, 32; P. Zoneff and E. Meumann, *Ueber Begleiterscheinungen psychischer Vorgänge in Athem und Puls*, in Wundt's *Philosophische Studien*, xviii., 1903, 1; M. Kelchner, *Die Abhängigkeit der Atem- und Pulsveränderung vom Reiz und vom Gefühl*, in *Archiv f. d. gesamte Psychologie*, v., 1905, 1; N. Alechsieff, *Die Grundformen der Gefühle*, in Wundt's *Psychologische Studien*, iii., 1907, 156; P. Salow, *Der Gefühlscharakter einiger rhythmischer Schallformen in seiner respiratorischen Aeusserung*, *ibid.*, iv., 1908, 1 ff.; F. Peterson and C. G. Jung, *Psycho-Physical Investigations with the Galvanometer and Pneumograph in Normal and Insane Individuals*, in *Brain*, xxx., 1907, 153.

On the biological significance of feeling, see H. Spencer, *Principles of Psychology*, i., 1881, pt. ii., ch. ix.; H. Ebbinghaus, *Grundzüge der Psychologie*, i., 1905, 568; D. C. Nadejde, *Die biologische Theorie der Lust und Unlust*, i., 1908. A genetic theory of feeling, in some respects akin to that of the text, but differing from it on important points, is worked out by J. M. Baldwin, *Mental Development in the Child and the Race: Methods and Processes*, 1895, 481 ff.; 1906, 457 ff.

## ATTENTION

§ 75. **The Attentive Consciousness.**—The word ‘attention,’ like the word ‘feeling,’ has been employed in the history of psychology to denote very different things. Attention has been regarded, at various times, as a peculiar power or capacity, the faculty of concentration, the ability to restrict at will the field of consciousness: as a peculiar form of mental activity, an effort that one puts forth or an initiative that one takes, radically different from the passivity with which impressions are received: as a state of the whole consciousness, a state of clear apprehension and of effective thought: as a feeling or emotion: and, finally, as a complex of sensations, and more especially of kinaesthetic sensations.

It is plain that not all these views can be correct, though every one of them can find a certain support in the facts of observation. When I am so deeply sunk in a scientific problem that I forget my headache, or fail to hear the dinner bell, I seem, pretty clearly, to be exercising the power of concentration. When I force myself to go to work, in face of the temptation to finish an interesting novel, I seem to be exerting a spontaneous activity, to be myself determining my world rather than determined by it. When, again, I wish thoroughly to understand a thing, to make myself master of it, I give it my full attention: attention is, then, that state of consciousness, that degree of being conscious, which guarantees the best



results of mental labour. When I am keenly attending, I am also keenly interested; and interest is a mode of affective experience. Lastly, when I am trying to attend, I invariably find myself frowning, wrinkling my forehead, holding the breath, setting the body in some definite and rigid attitude. All such sets and movements give rise to characteristic complexes of cutaneous and kinaesthetic sensations. Why should not these sensations represent, in psychology, what we popularly call attention?

The appeal lies to experimental introspection: and our rule must be here as it has been elsewhere, that if the experimental results come into conflict with our preconceived opinions, the opinions are to be given up. But before we enter upon the experimental study of attention, let us try a bit of straightforward analysis; let us look at a typical attentive consciousness, and see whether our schooling in psychological method helps us to dissect it.

The most promising case will be a case of suddenly aroused attention. Suppose, then, that I am working or reading quietly, and that a telephone message or the entrance of a visitor suddenly demands my attention. The first thing that happens is that there is a redistribution of the entire contents of consciousness. The incoming ideas—my friend's business or the subject of the message—drive to the centre, and everything else, my previous occupation as well as my sensory surroundings, are banished to the outskirts. Consciousness, in attention, is patterned or arranged into focus and margin, foreground and background, centre and periphery. And the difference between the processes at the focus and the processes in the margin is, essentially, a difference of clearness: the central area of consciousness lies clear, the more remote

distributed  
percept's  
redistribution

regions are obscure. In this fact we have, indeed, the key to the whole problem of attention. In the last resort, and in its simplest terms, attention is identical with sensory clearness.

However, we must confine ourselves to observation, and not anticipate. The attentive consciousness is arranged as clear and obscure: so much is evident. Is the consciousness affective? Not necessarily. We may greet our friend with an absorbed interest, with pleasurable concern or with foreboding of unpleasantness; but we may also give him a perfunctory and mechanical attention, which leaves us wholly unaffected. Is the consciousness kinaesthetic? Again, not necessarily. There may be a wide-spread arousal of kinaesthetic sensations, or there may be no sensible change in the muscular system: it depends upon circumstances. So that it appears, even to unaided introspection, that the redistribution of contents into the groups of clear and obscure is the one universal and characteristic feature of the attentive consciousness.

It should hardly be necessary to repeat here that modern psychology knows nothing of a permanent mind, or of faculties or activities or manifestations of such a mind (§ 3). Whatever attention is, it must be described in terms of mental processes, sensations and images and affections, and explained by reference to its physiological conditions. On the other hand, attention offers itself as an admirable touchstone by which the views of modern psychology may be tested. For the whole situation in attention seems, at first sight, to imply a selective and spontaneous mental activity. As I lean back in my chair to think out a psychological problem, I am subject to all sorts of sensory stimuli: the temperature of the room, the pressure of my clothes, the sight of various pieces of furniture, sounds from house and street, scents coming from the room itself or borne in through the open window,

organic excitations of different kinds. I could easily lapse into a reminiscent mood, letting these impressions suggest to me scenes from my past life. I could easily give the rein to my imagination, thinking of the further business of the day, anticipating some event that is to happen in the near or distant future. But I am, in fact, perfectly well able to ignore all distractions, and to devote myself entirely to a single self-chosen idea, — the idea of the problem that awaits solution. It is true, then, that this idea is clear and central, while all the other conscious processes of the moment are obscure and marginal. But it seems to be true, also, that the clearness of the idea is rather a matter of the mind's own concentration than of any character of the idea itself. Besides, I can turn my mind, if I like, to something entirely different; I can give up the problem whenever I feel disposed.

That is the situation in attention, as popular psychology sees it. We must take up the implied challenge, and see whether our own methods can throw any further light upon the question.

§ 76. **The Development of Attention.** — Attention, as the term is popularly understood, has two forms. It may be ~~passive and involuntary~~, or it may be active and voluntary. These forms are, in fact, characteristic of different stages in mental development; they differ simply in complexity, as earlier and later; they show us the same type of consciousness, but at different periods of our mental growth. It will, however, clear the ground if we now enquire wherein their difference consists, and what are the conditions of their occurrence.

There is, in the first place, an attention that we are compelled to give and are powerless to prevent. Or, to put the same thing in other words, there are impressions that we cannot help attending to, that take consciousness by storm. Intensive stimuli belong to this class. Loud sounds, bright lights, strong tastes and smells, severe

pressures, extreme temperatures, intense pains, — all these are clear in virtue of their intensity; they attract our attention, as the phrase goes, in spite of ourselves; they force their way to the focus of consciousness, whatever the obstacles that they have to overcome. In the same way, there are certain qualities that irresistibly draw the attention: here belong in the writer's experience — though there are very considerable differences between individuals — the taste of bitter, the smell of musk, the sight of yellow. A stimulus that is repeated, again and again, is likely to attract the attention, even if at first it is entirely unremarked. Sudden stimuli, and sudden changes of stimulus, have the same effect. So with movement: the animal or bird that crosses the landscape, the melody that rises and falls to a steady, uniform accompaniment, the insect that crawls over our hand as we lie upon the grass, these things constrain us to attend to them. Novelty, too, arrests the attention. The novel impression is, in psychological terms, the impression that finds no associates when it enters consciousness; that stands alone, in isolation. Such an impression, if it is at all intensive, becomes clear in its own right; it is startling, just as the "sudden stimulus is surprising" and the "moving stimulus is disturbing." And lastly, paradoxical as it sounds, impressions that are in a sense the reverse of novel claim the attention, — impressions that fit in with, are associated to, the present trend of consciousness. The collector, the inventor, the expert are roused to keen attention by stimuli which the rest of the world pass without notice. Most of the striking coincidences in life are accounted for by this law: you are thinking about certain things, and something happens that, because you are thus thinking and because

*Handwritten notes:*  
Habit  
of  
clear  
and  
now

it is akin to the subject of your thought, captures your attention. What a remarkable coincidence! you cry: but if you had been thinking of something else, there would have been no coincidence. The man in Mr. Kipling's story who wondered, years after the event, how in the world he could have written such good stuff as that, had written under this same law of attention; for when you are thoroughly absorbed in a topic, relevant facts and ideas crowd in upon consciousness; the mind stands wide open to them, while it is fast locked against the irrelevant; and you surpass yourself.

Here, then, is a fairly long list. Intensity, quality, repetition, suddenness, movement, novelty, congruity with the present contents of consciousness, are one and all determinants of attention. When they appear, we have to attend to them, even if we have grounds for attending elsewhere. Attention thus determined, attention at the first stage, is usually termed passive or involuntary attention. Unfortunately, a passive implies an active; and active attention is, as we shall see, a misnomer. Other names have been suggested; but we shall do best to speak simply, in this connection, of primary attention.

It is worth noting that all the members of our list are of a kind to produce a powerful effect upon the nervous system. Intensive stimuli naturally set up intensive nervous excitations; and intensive excitations will not be easily checked or obscured by rival excitations. The qualitative stimuli that compel attention appeal to some peculiar susceptibility of the nervous system. Repeated stimuli have a cumulative influence. Sudden stimuli impinge upon nervous elements that have recently been free from stimulation of their particular kind, that is, upon elements of a high degree of excitability; and it is also probable that the excitations which they arouse suffer less dispersion and diffusion, within the

nervous system, than those set up by the gradual application of stimulus. Moving stimuli affect different nervous elements in quick succession; there is no possibility of fatigue or of sensory adaptation; in a way, therefore, the action of the moving stimulus is cumulative. Novel stimuli, being isolated stimuli, arouse excitations which are not interfered with by others; their action is akin to that of sudden stimuli. As for the effect of congruity with consciousness, it is clear that the more nearly an incoming excitation coincides with an excitation already in progress, the more easily will it make its way within the nervous system, and the more dominant will it become. The novel and the familiar may thus have a similar excitatory value.

Primary attention, however, represents a genetic stage, the earliest stage of attentional development. Hence it is not enough to look at its determinants physiologically; we must also view them biologically. And if we do this, some of them at any rate take on a new significance. Any nervous system will be powerfully impressed by intensive stimuli; any organism that has risen high enough in the scale of evolution to have a consciousness made up in part of ideas, of memories and imaginations, will be powerfully impressed by stimuli that are congruent with those ideas: it is precisely to such stimuli that the gates of the nervous system lie open. But what of novelty and suddenness and movement? These have a special biological meaning: for the new and the sudden and the moving are probable sources of danger, and the creature that failed to attend to them would soon have ceased to exist.

There are, however, many occasions when, so far from the impression's drawing and riveting our attention, it seems that we are holding our attention by main force upon the impression. A problem in geometry does not appeal to us as a thunder-clap does. The thunder-clap takes unquestioned possession of consciousness. The problem has only a divided claim upon us: there is constant temptation to wander away from it and to attend to something else. We continue attending; but we have to

Biolo  
back

2200  
atten



make ourselves attend. In many of the psychological experiments that we have described, the object of attention — an obscure organic sensation, a minute qualitative difference — is something which of itself, so far from attracting notice, would seem to be eminently fitted to escape it. Attention to such an object is usually termed active or voluntary attention; we shall call it secondary attention.

For it is not really active attention, if the adjective implies anything like a special and spontaneous mental activity. It is simply the resultant of a conflict of primary attentions. There are rival claimants for the chief place in consciousness, and the standing-room is limited. So the attention, as we say, is divided; or perhaps it oscillates between the various impressions presented. Secondary attention is attention under difficulties, attention in face of competitors, attention with distraction. But that is its whole secret; it has no novel feature.

Secondary attention is a necessary consequence of a complicated nervous organisation. Let us take an imaginary case: the case of an animal endowed with two sense-organs, an eye and an ear. Suppose that such an animal is exposed, at the same moment, to two different stimuli, a bright light in front of it and a loud sound at its side. It cannot afford to neglect either. Hence it will attend, first, to the stimulus which has the greater attractive force; but then, having attended to that, it will at once turn its attention to the other: and so there will be a seesaw of light and sound at the focus of consciousness, a quick succession of primary attentions. This, as we shall see presently, is not all of the psychological story; but it is the essential point.

Now take a case that lies nearer home. Suppose that you are in your room, preparing for to-morrow's examination, and that you hear an alarm of fire in a neighbouring street. Both ideas, the idea of examination and the idea of fire, are imperative; there is a conflict. The cortex is set in one part for work: and this set-

activity? It does not decide himself in  
 regarding, he has same cause of  
 in attention.

x



ting is reinforced by a large number of associated excitations,— the nervous processes corresponding to ideas of the examination mark, the consequences of failure, and so on. The cortex is set in another part for going to the fire: and this setting is similarly reinforced, by the processes corresponding to the ideas of a run in the fresh air, an exciting scene, a possible rescue, and so on. The struggle may last some little time, and its effects may persist for a while after you have made your choice. So long as there is any trace of it, your attention is secondary or 'active' attention.

There is yet a third stage in the development of attention; and this consists in nothing else than a relapse into primary attention. As we work at our problem in geometry, we gradually become interested and absorbed; and presently the problem gains the same forcible hold over us that the thunder-clap has from the moment of its appearance in consciousness. The difficulties have been overcome; the competitors have been vanquished; the distraction has disappeared. There could hardly be a stronger proof of the growth of secondary out of primary attention than this fact, of everyday experience, that secondary attention is continually reverting to the primary form.

We spoke just now of making a choice between work for the examination and going to the fire. The making of a choice means, of course, that the stronger of the two conflicting forces, the rival excitatory processes, has won the day; and the traces of the struggle that persist after the choice has been made mean that the victory has not been absolutely complete. If experiences of the sort are often repeated, so that a habit is set up,— a habit of work or a habit of play,— then the struggle is brief, and secondary attention is quickly replaced by primary.

The mention of habit leads us to a further, and a very important point. This nervous system of ours, which is the scene of

the conflict in secondary attention, has a long evolutionary history. We are not all born equal; we are born with nervous systems that bear upon them a certain hereditary stamp, that already have within them lines of less and lines of greater functional resistance. The poet, we say, is born and not made; and to a certain extent, if the phrase is permitted, we are all of us born and not made. On the other hand, the child's nervous system is exceedingly plastic and impressionable; it is easily moulded by education; so that, to quote another current saying, habit may become second nature. The leanings and aptitudes and predilections that we show in adult life are, then, the resultant of two influences, heredity and education, nature and nurture. Now the important point in the present connection is this: that the side which finally proves to be the stronger, in the struggle of secondary attention, need not necessarily be the consciously stronger. The conflict between working and going to the fire may lead to a victory for work, in spite of the fact that consciousness is more fully occupied by fire-ideas than it is by work-ideas. The nervous system, in virtue of its own bias or leaning, has brought up further reinforcements on the side of work, and these reinforcements have directed or guided consciousness although they are not themselves represented in consciousness.

The guiding influence of nervous bias is not a matter of inference, still less a matter of speculation; it can be demonstrated in the psychological laboratory. Suppose that we are measuring the time required to reply to a spoken word by another word of the same class or kind: to associate dog to cat, table to chair, and so on. The experimenter prepares a long list of words: cat, chair, and so forth. Then he explains to the observer the precise nature of the experiment: I shall call out certain words, he says, and you are to reply, as quickly as you can, with words of the same class; if I say horse, you will mention some other animal, and if I say pen, you will mention something else that has to do with writing. The observer understands, and the experiment begins. Suppose, further, that the experiments have been continued for some days. The experimenter has no need to repeat his explanation at every sitting; the observer takes it for granted that

he is still to reply with a coordinate word. And suppose, finally, that some day, after a week's work, the experimenter interrupts the series, and asks: Are you thinking about what I told you to do? The observer, fearing that he has made some error, and feeling very repentant, will say: No! to tell the truth I had absolutely forgotten all about it; it had gone altogether out of my mind; have I done anything wrong? He had not done anything wrong; but his answer shows that a certain tendency, impressed upon his nervous system by the experimenter's original explanation, has been effective to direct the course of his ideas long after its conscious correlate has disappeared. And what happens here, in the laboratory, happens every day of our lives in the wider experience outside the laboratory.

In summary, then, attention appears in the human mind at three stages of development: as primary attention, determined by various influences that are able to produce a powerful effect upon the nervous system; as secondary attention, during which the centre of consciousness is held by a certain perception or idea, but is held in face of opposition; and lastly as derived primary attention, when this perception or idea has gained an undisputed ascendancy over its rivals. The attentive consciousness is at first simple; it then becomes complex,—reaching, indeed, in cases of hesitation and deliberation, a very high degree of complexity; and then it simplifies again. Looking at life in the large, we may say that the period of training or education is a period of secondary attention, and that the following period of achievement and mastery is a period of derived primary attention. Looking at experience more in detail, we see that education itself consists, psychologically, in the alternation of the two attentions: habit is made the basis of further acquisition, and acquisition — gained with pains — passes

in its turn into habit; the cycle recurs, so long as the organism retains its nervous plasticity. Secondary attention thus appears, everywhere, as a stage of transition, of conflict, of waste of nervous energy, though it appears at the same time as the necessary preliminary to a stage of real knowledge.

We may now return to our analytical study of the attentive consciousness. There are three stages of attention, but there is only one type of attentive consciousness; the three stages show differences of complexity, but not differences of kind.

In the meantime, it may prevent a possible misunderstanding if we say, explicitly, that the greater complexity of consciousness in secondary attention does not necessarily mean a greater number of constituent mental processes. The single object of primary attention may be extremely complex; the competing objects of secondary attention may be relatively simple. The complexity, then, is a complexity, not necessarily of conscious contents, but rather of conscious pattern, of the disposition of the contents. In primary attention, consciousness flows smoothly within a definite channel; in secondary attention, its course is zigzag, meandering through various channels. The number of mental processes given in secondary attention may be, and often is, much larger than the number given in primary attention; but the characteristic difference between the two consciousnesses lies elsewhere. Consciousness in primary attention may be represented by a series of parallel straight lines, each standing for some mental process that enjoys its full normal duration; consciousness in secondary attention must be represented by a pattern of shorter and variously directed oblique lines, each standing for some mental process whose progress has been arrested by the advent of a rival.

§ 77. **The Two Levels of Consciousness.** — The rough analysis of § 75 led us to conclude that the attentive

consciousness is always arranged in a dual pattern of clear and obscure, focus and margin. We might represent it by means of two concentric circles, the inner and smaller bounding the region of clearness, or containing what is called the object of attention, and the outer and larger bounding the region of obscurity or of inattention. A more serviceable dia-

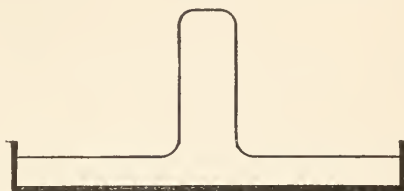

FIG. 40. Diagram of the Attentive Consciousness. The stream of consciousness, outlined by the thin line of the Fig., is supposed to be moving towards you from the plane of the paper; the thick lines represent the neural channel in which the stream is flowing.

gram, however, is one that represents the stream of consciousness as running at two different levels, the higher that of the clear and the lower that of the obscure processes in consciousness. We shall make use of this diagram in what follows.

Let us begin by making an observation for ourselves. Figure 41 is a puzzle picture; it is a drawing of the left hemisphere of the brain, but it is something else also. Look at it, and try to find what it conceals. While you are searching, the whole drawing is at the upper level of consciousness, and the rest of your experience is at the lower level. Suddenly you find what you are looking for: and what happens? Why, the moment you do so, the picture of the brain drops clean away from the upper level: the concealed outlines stand out with all imaginable clearness, and the form of the brain is no clearer than the feel of the book in your hand. The first two-level consciousness has been replaced by a second, and the drop of the original object of attention from crest to base of the attention-wave is very striking.

In one respect, this observation is not typical. When you have solved the puzzle, you experience a keen satisfaction; and affective processes are not always found in the attentive consciousness. In all other respects, the observation appears to the writer to be typical. The object of attention does not glide, by slow degrees, to the higher level, but rises at a single step; now you are attending to one thing, and now you find yourself attending to another. It should be said, however, that this view is disputed. Some psychologists believe that the attentive consciousness shows,



FIG. 41. Drawn by R. Gudden, Frankfurt a. M.

not two different levels, but a single rising and falling slope; they believe, that is, that processes of all possible degrees of clearness may coexist in the same consciousness. Others believe that there are more than two levels, — three, for instance: the levels of attention, of inattention, and of a still deeper, subconscious obscurity. We return to the matter again on pp. 290, 302.

The main characteristic of the processes at the upper conscious level is their high degree of clearness. We mentioned clearness, in § 12, among the attributes of sensation, and the term carries its meaning with it. A



process is clear or vivid when it is at its best, when it is making the most of itself in experience. Clearness is an intensive attribute, in the sense that it shows degrees of more and less; but it is altogether different from intensity proper. When, for instance, you are listening to a very faint sound, the sensation of noise may be the clearest thing in consciousness, although its intensity is minimal. Indeed, there is no difficulty whatsoever, after a little practice, in distinguishing introspectively between the clearness and the intensity of any given mental process.

It is, however, a much debated question whether clearness and intensity, though distinct attributes of sensation, are not always connected in experience. Does not a rise in clearness mean also a rise in intensity? The very faint sound may be clear, in spite of its weakness: but is it as weak as it would be if it were less clear? In popular phrasing, does not attention intensify its object? We find every possible answer to these questions. Some psychologists believe that change in clearness makes no difference in intensity. Others believe that it makes only an apparent difference. Increase in clearness, they say, means a more independent status in consciousness; and this independence, this freedom from interference, allows the other attributes of sensation to come to their full conscious rights. Intensity thus makes all the effect that it has in it to make; it appears to be increased, whereas in reality it is simply getting — what without clearness it could not get — fair play in consciousness. Others, again, think that clearness does bring with it an increase of intensity; and yet others assert that it means a decrease. In the writer's judgment, the third of these views, that intensity is raised along with clearness, is the most probable.



The belief that change in clearness makes no difference in intensity rests upon facts of everyday observation : your surroundings do not brighten up as you attend to the lamp, the clock does not begin to tick more loudly as you listen to it. But, first, this sort of observation is very unreliable ; if you try it for yourself, you will find how far you are from any real comparison of the more clear and the less clear process. And secondly there are facts on the other side : you can hear, with attention, a faint sound that you cannot hear if you do not attend. The next hypothesis, that the change in intensity is only apparent, contains an element of truth ; but in so far as it is an attempt to reconcile the first and the third, it will not come into account until the third has been disposed of. The issue lies, therefore, between the third and the fourth views, that attention intensifies and that attention weakens its object ; and the test is experiment. There is evidence on both sides ; but it appears to the writer that the evidence for weakening is ambiguous, and the evidence for intensification clear and decisive. Suppose, for instance, that two sounds, a weaker and a stronger, are presented to the observer in quick succession ; and suppose that he gives full attention to the weaker, but that his attention is diverted from the stronger by some interfering stimulus, for instance, by a strong odour. If he judges that the two sounds are of equal intensity, still more if he judges that the objectively weaker sound is the more intensive of the two, we have an increase of intensity with attention or (what is the same thing) a decrease of intensity with distraction. And this is what happens.

It is not at all surprising that we should find an intimate relation between clearness and intensity ; for, as we said in § 76, all the conditions of a high degree of clearness are also conditions for the powerful impression of the nervous system. Nor does the connection of the two attributes affect anything that we have said in §§ 62 ff. : for the intensities which obey Weber's Law are, of course, intensities at maximal clearness. —

It does not seem probable that clearness brings with it any change in extent or duration. Processes, however, that would ordinarily be curtailed, swamped by stronger processes, may — if

they are clear—be followed for a longer time in their course through consciousness, and may thus be apparently lengthened.

We may now interpret Fig. 40 to mean that the processes at the crest of the attention-wave are both clearer and stronger than the processes at the lower level of consciousness. These are the attributes that give the object of attention its special value for memory and imagination and thought.

§ 78. **The Kinaesthetic and the Affective Factors in the Attentive Consciousness.**—We may assume that attention, in its beginnings, was a definitely determined reaction of the whole organism—sensory, affective, motor—upon a single stimulus. The strong or sudden or novel or moving thing was perceived, as sight or sound or touch. It was also, as we have said (§ 76), felt as startling or disturbing or surprising. The affective element in the experience expressed itself in a change of the great bodily functions. At the same time the animal took up an attitude to the stimulus, in the literal sense; faced it, as peering and listening and frightened animals face such stimuli to-day. At this stage, then, the redistribution of the sensory processes in consciousness, the clearing of some and the obscuring of others, was accompanied both by affection, and by kinaesthetic sensations due to internal bodily changes and to muscular attitude.

Secondary attention has its origin in a conflict of primary attentions: in the rivalry of clear perceptions and in the struggle of incompatible motor attitudes. The perceptions may be either pleasant or unpleasant; the motor restlessness will be unpleasant, reflected in an affective uneasiness. We have, now, a survival of this primitive state

of affairs in the effort which always comes with secondary attention. We naturally dislike to work ; work of any sort means effort. And effort is itself a sense-feeling, made up of unpleasantness, and of a complex of kinaesthetic and organic sensations. Experiments by the method of expression show that breathing in secondary attention is likely to be inhibited, to become shallow; and there are other bodily changes, correlated in part with the unpleasant affection, in part with the motor restlessness.

As the nervous system developed, image supervened upon sensation, and conflict and rivalry were largely transferred to the field of ideas. Congruity with consciousness now took its place among the determinants of primary attention. There was a radical change in the make-up of consciousness; and one aspect of the change was the weakening of the kinaesthetic and affective factors in attention. The effort that we make when we sit down to work, and the difficulty that we feel for the first few minutes of working, are the direct descendants of the older uneasiness and the older motor restlessness, but they are degenerate descendants, mere echoes of the primitive experiences. So degenerate are they, that some psychologists refuse to regard effort as a sense-feeling: Wundt makes tension a simple affection, and others see in it a new kind of mental element, a conative element or elementary process of will. There is no introspective warrant for either view. Effort, in whatever context we take it, proves to be analysable; it reduces to affection and sensation.

The last stage in this development is given with the passage from secondary to derived primary attention. We began with an affective sensorimotor reaction, the reaction

of the whole organism upon a single stimulus. From that we passed to sensorimotor conflicts, still strongly affective. Then images come in, and separate the sensory from the motor, the reception of stimulus from the movement of response. Henceforward secondary attention may be concerned mainly with the stimulus (receptive attention), or mainly with ideas (elaborative attention), or mainly with movements (executive attention): being secondary attention, being, that is, attention under difficulties, it is always tinged with effort. Finally, secondary passes over into derived primary attention; and when it does, affection and kinaesthetic sensation cease to be necessary factors in the attentive consciousness. Thus, to begin with receptive attention, we may open our morning's mail with keen excitement, or we may attend to it with no change either of affective or of kinaesthetic experience. We may, in elaborative attention, be absorbedly interested in an argument, and allow the body to grow stiff and cramped; or we may take the argument quietly and indifferently. We may, in executive attention, be wholly bent upon the successful performance of a skilled action, and may tire ourselves out in attempting it; or we may make the movements easily and as a matter of course. What we call habitual, mechanical, perfunctory attention involves the two conscious levels of clearness and obscurity, but does not involve either affection or kinaesthesia.

It must be remembered that attention is not something rare and occasional in the mental life, but is the normal state of our consciousnesses. When we charge other persons with inattention, we do not mean that they are, literally, non-attentive; we charge them with inattention to a particular topic; and this inattention means, simply, that they are attending to something else. A

strictly one-level consciousness is certainly abnormal, and probably never occurs in the normal waking state; though it may be realised, or at least approximated, in idiocy (lower level) and in profound hypnosis (upper level). But if attention is thus the rule and not the exception, there is nothing surprising in its becoming a matter of habit, in its leaving us — in both senses of the word — unmoved.

The occurrence of kinaesthetic sensations as the object of attention (for instance, of the executive type) must, of course, be carefully distinguished from their arousal by the motor attitude of the organism in attention. It is the second sort of kinaesthesia whose weakening and disappearance we have traced.

§ 79. **The Experimental Investigation of Attention.** — In taking up the study of sensation, experimental psychology was greatly helped by physics and physiology. Instruments and methods of research were at hand, and needed but little modification to render them serviceable; and a large body of observations, scattered through the physical and physiological journals, could be transferred directly to their proper place in the new science. Hence, from the very outset, the problems of the quality and intensity of sensation were attacked with good hope of success; and although, as is always the case, all sorts of unforeseen difficulties arose, our knowledge of these attributes has steadily advanced.

The experimental study of affection began much later. Here, therefore, we have to make up for lost time. Still, we are entering on the work in the light of all the experience that we have gained with sensation, and physiology has again come to our aid with the instruments needed by the expressive method. Another ten years will probably suffice to lay the foundations of a stable affective psychology.

Interest in attention goes further back. As soon as the work upon sensation had been fairly started, experimental psychology turned to the investigation of attention. Here, however, it found no outside assistance; physics and physiology had nothing to offer; there was only a popular psychology to build upon. And so the experimentalists made the mistake — natural, almost inevitable, but still a mistake — of grappling with the total attentive consciousness, all at once, instead of beginning with a psychology of clearness, and developing it on the lines of the psychology of intensity and quality. The consequence is that we know less about attention than we should; a good many of the earlier studies have to be done over again, little bit by bit; the problems have to be split up, and made more manageable. Even so, the experimenter of to-day is hampered by the past; he wishes to keep all the results of previous work that can be kept, and therefore, while he makes his problems as narrow and definite as possible, he shapes them in accordance with psychological tradition.

"But science must set out from the simple, and move gradually to the complex." A total consciousness is the most complicated thing that psychology has to deal with, and its treatment should come last of all. If we want to understand attention, we must begin at the other end, with an exhaustive study of the attribute of sensory clearness.

A few names and dates may be given in illustration. The psychology of intensity is connected especially with the name of Fechner, who published his *Elemente der Psychophysik* in 1860. The psychology of quality is connected, similarly, with the name of Helmholtz, who published the *Handbuch der physiologischen Optik* in 1856-1867, and the *Zur Lehre von den Tonempfindungen*



in 1863. The experimental study of attention may be dated from 1861, when Wundt (*Beiträge zur Theorie der Sinneswahrnehmung*, 1862 ; *Human and Animal Psychology*, 1896, 270) began the series of researches that have culminated in his doctrine of apperception. The experimental study of affection may be dated, in the same rough way, from the appearance in 1892 of A. Lehmann's *Die Hauptgesetze des menschlichen Gefühlslebens*, which took the prize offered by the Royal Danish Academy of Sciences in 1887 for a scientific work upon the feelings.

In the meantime, a glance at Fig. 40 will show that the attentive consciousness sets a number of experimental problems. There is, for instance, the problem of the area of the attentive-wave, or of the range of attention. The question: How many things can we attend to at once? has often been asked, and has been very variously answered. A busy man will tell you, if you interrupt him, that he can't possibly attend to more than one thing at a time. On the other hand, it is related that Julius Caesar and the first Napoleon could carry in their heads the topics of a dozen despatches, and could dictate them without confusion to as many secretaries. There is also the problem of the length of the attentive-wave, or of the duration of attention. For how long a time can attention be maintained? In everyday experience, the object of attention is continually changing. Does attention lapse, as we pass from object to object? Then there is the problem of the height of the attention-wave, or of the degree of attention. How many different degrees can be distinguished, and how can they be measured? We speak roughly of close or rapt or absorbed or concentrated attention, and we contrast it with wandering or fitful or divided attention. But this, after all, is much like saying that our sensations of



light are black, white and grey; we want a more exact statement, and if possible a statement in numerical terms. The present condition of our knowledge, on these and kindred topics, is briefly set forth in the following sections.

§ 80. **The Range of Attention.**—Our problem is to determine how many impressions can be attended to together, without decrease of the clearness which each one of them would possess if the attention were directed to it alone. We can approach the problem in two ways, by a simultaneous and a successive method. Thus, we may present a number of stimuli to a sense-organ at the same time, and gradually add to them, until it becomes impossible to attend to all at once. In the case of sight, for instance, we may show the observer a number of dots, lines, letters, numerals, simple geometrical figures, bands of colour, etc., laid upon the same background. Or we may give the stimuli in succession, gradually increasing their number till the point is reached at which the first drops into obscurity as the last is given. This method answers best with auditory stimuli. In both forms of the experiment, the object of enquiry is the same; we wish to determine the limit of complexity at which the attention becomes unable to cope with the stimuli offered to a particular sense-organ. And in both the same result is reached; the attention is able to embrace six, simultaneous or successive impressions, of a relatively simple kind and of unitary character.

*Method of Simultaneous Stimuli.*—Experiments are made by means of the tachistoscope, an instrument which, as its name implies, permits the exposure of a limited field for very brief periods of time. The time of exposure must be short, since

otherwise the eye may sweep rapidly over the stimuli, leaving

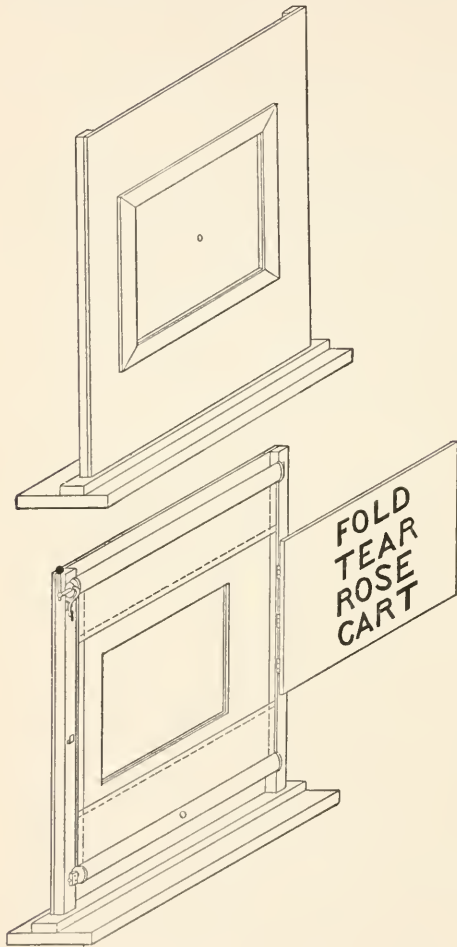

FIG. 42. Demonstrational Tachistoscope. A black curtain, mounted on strong spring rollers, is stretched behind a square opening in a black wooden screen. The upper Fig. (front) shows the curtain and the white fixation-mark. The lower Fig. (back) has the card-carrier thrown back to show the square opening in the curtain itself.

some to be remembered while others are directly attended to; in this case we should be dealing, not with the grasp of a single attention, but with a series of attentions. And the exposed field must be so small that it is readily taken in by the eye at a glance, without eye-movement, since otherwise the obscurity of the outlying stimuli may be a matter, not of the limit of attention, but of indirect vision (§ 20).

If letters are employed as stimuli, they must form a meaningless series, such as *RKZT*. It has been found that a familiar word of three or four letters can be apprehended by the attention as if it were a single letter or geometrical figure; it is attended to, not as a series of letters, but as a single impression.

For the same reason, the attention can deal with numerals better than with disconnected letters; any combination of numerals means something, makes sense. Nos

The maximal range of the visual attention, for a practised observer, comprises six impressions; individual ranges differ between the limits of four and six. Experiments with simultaneous impressions of touch have given a like result; a practised observer is able to localise six scattered points correctly. This observation, however, needs confirmation.<sup>1</sup> 6

*Method of Successive Stimuli.* — The running weight upon the tongue of a bell-metronome is set for two hundred beats in the minute. The experimenter marks off two series of beats by sounding the bell simultaneously with the first beat of each series. The observer is required to say whether the two successive series are equal or unequal. He must not count, of course; counting would mean that a separate attention was given to every beat.

Accurate judgment is impossible in the case of series which consist of more than six impressions. And if the metronome could be run very slowly, — say, at fifteen in the minute, — the range of attention would be no more than six single beats. But just as in the previous experiment a short word was equivalent, for the attention, to a single letter, so here a group of beats may, under certain conditions, be equivalent for the attention to a single beat. As the rate of the metronome is increased, we cannot help reading into the succession of strokes a more or less complicated rhythm. At first, with rates that are still fairly slow, the beats group themselves into twos or threes, and the attention is still adequate to six impressions, — six rhythmical units of two X

<sup>1</sup> It is natural to recall, in this connection, that the point-characters of the Braille and the New York Point alphabets for the blind both alike ring the changes on a single symmetrical arrangement of six dots; and it is tempting to suppose that the limit of six was set by the limit of the range of tactual attention. But, as a matter of fact, the suggestion of the sixfold unit came from visual memory of the double-six domino: no preliminary experiments were made on touch. It also seems certain that blind readers do not, in general, distinguish the separate dots, but apprehend the total form of the letter, as if the dotted lines were continuous. X

beats (twelve beats in all) or six rhythmical units of three beats (eighteen beats in all). Finally, at the rate specified above, the attention can cover only five impressions, five rhythmical units: but these may now consist of eight or even, it is said, of twenty-four single beats; so that the series of five impressions consists of forty or even of one hundred and twenty metronome strokes. The groups of eight and of twenty-four are apprehended as units, akin to the short word of the previous method.

This result agrees very well with the canons of musical and poetical practice. The musical phrase never contains more than six measures, the poetical verse or line never contains more than six feet; a seven-measured phrase or a seven-footed line falls to pieces, ceases to be unitary. And the rhythmical wholes of a higher order, the period in music and the stanza or strophe in poetry, never contain more than five phrases or verses; as a rule, neither contains more than four.

*Minor Differences of Clearness at the Upper Conscious Level.—*

We have seen that the short word, the complexes of geometrical figures, and the rhythmical unit have, for the attention, the value of single impressions. Since they stand at the upper level of consciousness, their component parts are all clear. But they are by no means equally clear. Think, for instance, of a simple rhythmical unit, such as we might read, in music, *ONE*—and two—and three—and four—and. Here the first member is the strongest and clearest, the fifth stands next in order, and the second, fourth, sixth and eighth are relatively weak and obscure. This means that the upper level of the attentive consciousness is, as a rule, wrinkled into smaller waves, and not smooth, as it is drawn in Fig. 40. There are degrees of clearness within the clear. And this, again, may account for the belief, held by some psychologists (§ 77), that all possible degrees of clearness may coexist in the same consciousness. See, however, p. 302.

Whether there are, in the same way, degrees of obscurity within the obscure, wrinkles or wavelets at the lower level of Fig. 40, is still uncertain. In any event, these minor waves at the two levels are quite shallow, and cannot mask the gross difference between the levels themselves.

§ 81. **The Duration of Attention.** — If, ten years ago, an experimental psychologist had been asked for how long a time a single wave of attention could last, he would have replied without hesitation: For a few seconds only. Many experiments have been made, he would have said, and all have led to the same result: that attention is not persistent, but intermittent, — rising and falling, waxing and waning, at very short intervals. If you attend as closely as you can to a simple sense-impression, it does not remain clear, but becomes alternately clear and obscure; the attention fluctuates.

If the same question is asked to-day, the reply must be that, while we know a good deal more about the general subject, we do not know how long attention may continue. It may, undoubtedly, remain constant for two or three minutes. In the writer's judgment, it may remain constant for much longer periods.

It has been customary to work with minimal stimuli, — stimuli so small, or so weak, or so little different from their surroundings, that the least slip of attention, the slightest loss of clearness, will mean the disappearance of their sensations from consciousness; for it is far easier to say that we do or do not hear or see something than it is to be sure that what we see or hear has grown more or less clear. Visual, auditory and cutaneous stimuli have been employed: light and colour, tone and noise, mechanical pressure and the interrupted current. You may picture the experiment by imagining yourself as seated at a table, gazing fixedly at a little disc of light grey on a white ground, or listening with all your ears to the faint hissing of a stream of fine sand, while your hand rests upon a pneumatic key, the pressure of which records the moments of disappearance and reappearance of the sensation upon a kymograph in the next room.

For the sensation does, at least in certain cases, disappear and reappear. The earlier experimenters found this fluctuation in all

three of the sense-departments mentioned, and they found it with images as well as with sensations. They accordingly assumed that

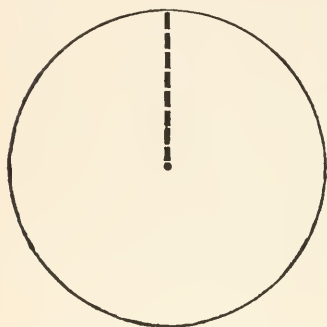

FIG. 43. Masson's Disc. The broken radius, painted black on white, gives rise, when the disc is rotated, to a series of grey rings, which grow lighter and lighter towards the periphery. The observer follows the grey out from the centre, and steadily fixates some point upon the outermost ring that he can distinguish.

it must be due to some common factor, and — naturally enough — ascribed it to the intermittence of attention. There were, it is true, objectors, who pointed out that the attention need not be involved. The eye has a mechanism of accommodation in the lens and its muscular attachments, and the ear has a similar mechanism in the muscle known as the *tensor tympani*, which pulls upon the drum-skin : why might not the intermittence of the minimal sensation be due to peripheral changes, to shifts of accommodation? But the reply seemed conclusive : visual fluctuation was observed during temporary paralysis of the muscles of accommodation, and even in the

case of aphasic subjects, patients whose eyes had lost the lens ; and auditory fluctuation was proved to occur despite the lack of a tympanic membrane. The theory of an intermittent attention had apparently won the day.

Nevertheless, the peripheral theory would not down. New experiments were made on touch ; and it was found that the minimal sensations set up by tiny weights and by a weak electric current do not fluctuate at all. If there is no outside disturbance, no itching or tingling or movement of the skin, the sensations run their course without interruption, until they fade out by adaptation. During these experiments it was observed that a steady attention might be kept up for at least two or three minutes. New experiments were also made on vision ; and it was found that visual sensations, too, tend to fade out into their background by adaptation, but that the course of adaptation in their case is interrupted,



—interrupted by involuntary eye-movement. The involuntary movements were timed, their direction was noted, and their extent was measured: in all three respects there was agreement between occurrence of movement and disappearance of sensation. Reappearance is due in part to the recovery of the retinal elements during movement, in part to the faulty adjustment of the eye; the eyeball does not return after movement to precisely the position that it had before movement, and the stimulus may therefore affect retinal elements which have not as yet been exposed to adaptation. It was found, further, that the negative after-image, the after-effect of local adaptation (§ 18), behaves in precisely the same way as the primary sensation; intrinsically, the course of the after-image is continuous, but it is interrupted when and in so far as eye-movement takes place.

So far, then, there is no need to invoke the attention, in order to explain fluctuation; we must suppose that the older observers were misled by preconceived opinion, or perhaps fell into errors of technique. But what, now, of tone and noise? Well, the fluctuation of tone and noise is still under discussion. Some observers have failed to get fluctuation with either; others get fluctuation with both. The reason for this difference of result may, possibly, be physical: it is extraordinarily difficult to maintain either a tone or a noise at absolutely uniform intensity; and a very slight change in objective intensity will, of course, bring a faint tone or noise to complete disappearance.

Here we are, for the present, at a standstill. We do not know how long a single wave of attention, carrying a single sensation of sight or sound or touch, may continue. Nor do we know for how long a steady level of attention may be maintained under the conditions of everyday life, where the object of attention is constantly changing. The single wave may continue at least for two or three minutes; the writer would not be surprised if it should turn out that the steady level may be maintained for two or three hours.

§ 82. **The Degree of Attention.**—The measurement of attention is one of the most pressing problems in experi-



mental psychology. If we could measure a man's capacity of attention, and could discover at any moment what proportion of that capacity he was using: if, that is, we could determine the greatest possible height of the attention-wave, in Fig. 40, and could find out its actual height in the case before us: then we should have a result of the greatest scientific importance and of the utmost practical value. Many experiments have been made, but the problem is still far from solution.

One difficulty has grown out of the popular use of the word attention. When the term is used without qualification, we naturally think of it as secondary attention; we think of the attention that the teacher enjoins on the pupil, of the effort of attention. Primary attention, whether original or derived, is so natural an attitude, so much a matter of course, that we hardly notice it: at most, when we see it in others, we say that so-and-so is absent-minded, or is in a brown study. This mistake, of identifying attention with secondary attention, is especially natural to the man of science, who is always puzzling and searching. So it comes about that psychologists have proposed to measure the degree of attention by measuring the degree of effort which accompanies it. We can measure sensation; kinaesthetic sensations indicate the degree of attention; hence, if we measure them, we have also measured attention.

The argument is fallacious, for the simple reason that the higher degrees of attention do not involve effort. When we have reached the stage of derived primary attention, effort has disappeared. The kinaesthetic sensations indicate, not degree of attention, but rather inertia of attention; strained attention is, as we have seen, atten-

tion under difficulties; the very fact that we try to attend means that we are not giving full attention. It would, accordingly, be nearer the truth to say that, the more pronounced the effort, the lower is the degree of attention.

Whether this statement is strictly true is, however, a moot question. Everyday observation shows that we attend best under slight distraction. If we are too comfortable, if the conditions are, so to speak, too favourable for attention, we do not attend; we let our mind wander. Now experiment shows that observers in the laboratory also do their best under slight distraction; a modicum of effort, a little bit of resistance to overcome, calls out their full powers. If the two observations are parallel, then we must say that effort is neither directly nor inversely proportional to the height of the attention-wave; the relation of effort to degree of attention is equivocal. There would be nothing to surprise us in this result; consciousness is exceedingly complex, and the nervous system upon which consciousness depends is exceedingly complicated. But are the observations parallel? The laboratory observers will not, in any case, give more than secondary attention; and the slight distraction, thrown in by the experimenter, may help them because it standardises the difficulties under which they attend; they are henceforth working against a single, constant difficulty, instead of meeting all sorts of distracting influences. On the other hand, a chair that is too luxurious to work in is a chair that favours primary attention, and letting the mind wander is simply a form of primary attention,—it is attention to ideas that fit in with the present contents of consciousness. On the whole, then, these observations do not appear to contradict the statement that, the greater the effort, the lower is the degree of attention. Still, this statement does not, of itself, bring us appreciably nearer to a measurement of attention.

In theory, the most promising method of measuring the attention would seem to be this: to determine, introspectively, how many degrees of clearness can be distin-

guished in the various departments of sense, and then to bring every degree of clearness into relation with a definite sort and amount of distraction. We should thus have degree of clearness correlated with intensity of distracting stimulus; in other words, we should know the highest degree of attention attainable with a given amount of distraction; and we might accordingly use the numerical value of the distractor as a measure of the degree of attention. If we knew, for instance, that a certain sensation may exist in ten different degrees of clearness: and if we had at our disposal ten stimuli which, introduced by way of distraction, would reduce this sensation from the corresponding degree of clearness to total obscurity: then we might calculate, from the effect of a particular distractor in the particular case, what fraction of maximal attention the observer was giving to the matter in hand. The method is cumbrous, and difficult to work out; but the writer believes that it may, some day, be successfully applied.

In the meantime, many rough tests of degree of attention have been devised for practical purposes. It is plain, for instance, that uniformity of performance, the maintenance of a steady level of achievement without marked variation from the average in either direction, indicates sustained attention, while the alternation of very good and very poor work indicates a vacillating attention. Tests of this kind are valuable so far as they go; but they cannot take the place of an exact psychological determination.

§ 83. **Accommodation and Inertia of Attention.** — We saw in § 76 that congruity with the contents of consciousness is one of the determinants of primary attention. It follows from this fact that, if two stimuli are presented for attention at the same time, the one of which is and the other is

not congruent with ideas already present, they will reach the crest of the attention-wave, not together, but in succession; the stimulus which fits in with the general trend of consciousness will outstrip its rival. We speak, in such cases, of a predisposition or accommodation of attention to a certain impression.

The fact of accommodation of attention may be illustrated by means of the arrangement shown in Fig. 44. A bell-metronome

is fitted with a cardboard arc, whose radius is the length of the pendulum. Scale divisions of  $5^\circ$  are laid off upon the circumference, the zero-point corresponding to the vertical position of the pendulum; an arrow-head of red paper serves as a pointer. The metronome is set to the rate of, say, 72 in the minute, and the bell rings at every complete oscillation. In the instrument used by the writer, the bell sounds when the pointer is at  $22^\circ$ .

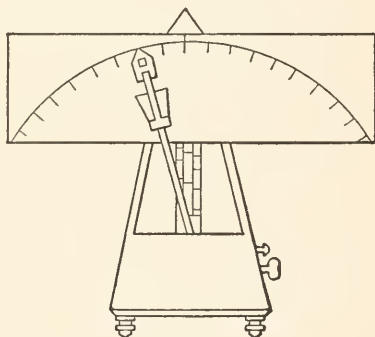

FIG. 44.

The pendulum is released, and the observer is asked to say how far the pointer has travelled when the bell rings. In a first observation, he is directed to attend to the moving pointer; the sound of the bell is secondary, — it floats, so to speak, upon the main current of visual change. Under these conditions, the pointer carries the bell out; the sound is not heard, on the average, until the pendulum points to  $30^\circ$ . In a second observation, he is directed to attend to the bell; the movement of the pointer is now secondary, — the expected bell-strokes stand out upon an indifferent shifting field. Under these conditions, the region of subjective coincidence lies between  $10^\circ$  and  $15^\circ$ . It is evident that, when the pointer is the main object of attention, the bell

stroke lags behind ; and that, when the bell is the object of attention, the pointer lags behind. In the first case, the pointer gets to  $30^{\circ}$  before the bell (which rang at  $22^{\circ}$ ) is heard ; in the second, the bell is heard (at  $22^{\circ}$ ) when the observed position of the pointer is only some  $15^{\circ}$ . The special accommodation of the attention may separate the two impressions by as much as  $10^{\circ}$  of the scale.

The same result appears even if no special directions are given to the observer. A dial is furnished with a circular scale, and a pointer is made to revolve before it, very much as a clock-hand revolves before the face of the clock. Once in every revolution, when the pointer has reached a certain scale-mark, a bell-stroke sounds. The observer is asked to say where the pointer is when the bell rings : no further instruction is given. He accordingly follows the course of the pointer with his eye, and in the first revolution refers the sound to some region of the circle. The second revolution narrows this region ; the third narrows it still more ; until finally there are only a few scale divisions with which the bell appears to coincide. In the meantime, attention has been sharpening to the sound ; an accommodation of attention has taken place ; the observer is predisposed to hear the bell at a certain instant. The instant comes ; the bell-stroke rises at once to the higher conscious level ; and there goes along with it the visual impression, not of the scale-mark with which it was objectively coincident, but of a scale-mark that the pointer had already traversed when the hammer struck the gong. It is as if there were a race to the top of consciousness, and the sound, outstripping the sight with which it started from the scratch, finishes abreast of a sight that had been given a certain handicap. The time-allowance that the sight receives is offset by the advantage accruing to the sound through accommodation of attention.

The time required for the accommodation of attention is about one and a half seconds. Hence, whenever quick and accurate observation is required in the psychological laboratory, it is customary to give a signal to the observer

a short two seconds before the stimulus is presented. This is the rule when a single accommodation is required. If the stimuli are frequently repeated, the attention is able, within certain fairly wide limits, to adapt itself to their rate of succession. It is possible, for instance, to read a rhythmical form into sounds that are as little as a fifth of a second and as much as three seconds apart (§ 80). The attention can accommodate itself to any rate between these extremes.

Accommodation implies inertia; and we find, in fact, that it is easier to continue a certain direction of attention than it is to strike out on a new path. You can follow the movement of a single instrument in the orchestra better, when there has been solo-playing before, than when the whole group of instruments begin together; you can finish a conversation, once begun, at a distance that would render the words of an unexpected question altogether inaudible; you can trace the upward course of a fire-balloon to a point at which it would otherwise be invisible. In the same way, it is difficult to break away from a current train of thought, and to give your full attention to a letter or a caller; and it is difficult to settle down again to your work after such an interruption. The description of inertia of attention must, unfortunately, be left in these general terms; no special investigation of its laws has as yet been made.

§ 84. **The Bodily Conditions of Attention.**—Theories of attention are as plentiful as theories of affection. Some of them have been worked out with great ingenuity of detail. Since, however, all alike are in large measure speculative, we shall here simply indicate, in bare outline,

what seems to be the most reasonable explanation of the attentive consciousness.

Neurologists are agreed that one nervous excitation may influence another in two opposite ways: by helping and by hindering, or, in technical terms, by facilitation and by inhibition. We may take an elementary illustration in each case. If a weak cutaneous stimulus is applied to the hind foot of a decerebrised frog, there is no visible effect; the limb remains passive. But if at the same time a light is flashed into the eye, the leg-muscles may respond by a strong contraction. Here we must suppose that the two excitations, the cutaneous and the visual, have in some way reinforced each other; there is nervous facilitation. Again, a pressure applied to one part of the frog's body will touch off a croak; a strong pressure applied to a different part will touch off a muscular contraction. But if the two pressures are applied together, the frog does not both croak and move; he does nothing at all; there is no response to the stimuli. Here we must suppose that the two excitations interfere with each other; there is nervous inhibition.

It seems plain that the conditions of the attentive consciousness are of these two kinds. The clear processes, at the crest of the attention-wave, are processes whose underlying excitations have been facilitated. Similarly, the obscure processes, at the lower level of consciousness, are processes whose underlying excitations have been inhibited. The attentive consciousness is thus conditioned upon the interplay of cortical facilitation and cortical inhibition.

When, however, we ask for further details; when we try to form a picture of what is really going on in the



cortex when facilitation and inhibition are at work; then we are thrown back upon speculation. Wundt, for instance, believes that there is a special cortical centre, in the frontal lobes, from which the inhibitions proceed.<sup>1</sup> His opinion carries great weight, and is supported by a very considerable body of evidence. Nevertheless, the action of what he terms the apperception centre is confessedly hypothetical. Other psychologists believe that the processes of facilitation and inhibition are diffused more or less widely over the entire cortex. But their agreement extends no further. One recent theory maintains, for example, that the clearness or vividness of a sensation is due to the complexity of cortical organisation, —to the numerous interconnections of the nervous elements, the extreme variability of the resistances which they offer, and the number of alternative paths that may be opened in turn to the excitation-process. Another lays equal stress upon this complexity of organisation, but uses it in precisely the opposite way: a sensation is clear when its excitation-process is strictly local, and obscure when the excitation-process is spread abroad into many cross-paths and over many systems of nervous elements. No one can say which is right and which is wrong; no one can say, for that matter, if either is right or if both are wrong. We must therefore suspend judgment, until more is known of the physiological mechanism of inhibition and facilitation.

<sup>1</sup> Wundt explains attention in terms of inhibition only, not of inhibition and facilitation.

## References for Further Reading

§§ 75–84. Special works dealing with the psychology of attention are W. B. Pillsbury, *Attention*, 1908; E. Dürr, *Die Lehre von der Aufmerksamkeit*, 1907; T. Ribot, *The Psychology of Attention*, (1888) 1890. The first of these books gives a general account of the place of attention in the mental life; the second is written principally in the interests of education; the third offers a ‘motor theory’ of attention, which is worked out in improved form by J. M. Baldwin, *Mental Development in the Child and the Race: Methods and Processes*, 1906, ch. xv. A brief review of experimental investigations will be found in the author’s *Lectures on the Elementary Psychology of Feeling and Attention*, 1908, Lects. v.–vii.

For Wundt’s doctrine of attention, see *Grundzüge der physiologischen Psychologie*, iii., 1903, ch. xviii.; for his theory of a special brain-centre for attention, *Principles of Physiological Psychology*, i., 1904, 315 ff. Other physiological theories are given by H. Ebbinghaus, *Grundzüge der Psychologie*, i., 1905, 628 ff.; W. McDougall, *The Physiological Factors of the Attention-Process*, in *Mind*, N.S. xi., 1902, 316; xii., 1903, 289, 473; xv., 1906, 329.

Important references are further, G. T. Fechner, *Elemente der Psychophysik*, ii., (1860) 1907, ch. xlii.; G. E. Müller, *Zur Theorie der sinnlichen Aufmerksamkeit*, 1878; T. Lipps, *Grundtatsachen des Seelenlebens*, 1883, 125, 151; W. James, *Principles of Psychology*, i., 1890, ch. xi.; W. Wirth, *Die experimentelle Analyse der Bewusstseinsphänomene*, 1908.

Recent work seems to show that there are two different types of the attentive consciousness. Some observers find that it always has the dual formation discussed in the text; others declare, just as definitely, that they can distinguish three or four simultaneous degrees of clearness. The results need confirmation; it appears, however, that the author, who belongs to the two-level type, has fallen in § 77 into the common psychological mistake of generalising his individual experience. It is some consolation that the multi-level modes of attention were first observed, under experimental conditions, in his own laboratory. Cf. L. R. Geissler, *The Measurement of Attention*, in *Amer. Journ. Psych.*, xx., 1909, 524 ff.

Since § 82 was written, a first attempt at the measurement of attention by the prescribed method has been made, with success, by L. R. Geissler, *op. cit.*, 475 ff.

# PERCEPTION

## SPATIAL PERCEPTIONS

§ 85. **The Sensory Attribute of Extent.** — We said in § 12 that visual and cutaneous sensations are spread out, areally, into length and breadth; they appear as spatial extents. This elementary character of outspread or expanse is the foundation upon which all the forms of spatial consciousness, delicate and refined as they are, have been built up. To realise it, we must go behind our adult modes of space-perception. The words 'area' and 'extent' naturally suggest to us some well-known surface, field or wall or table; and the surface has a definite form, a definite size, a definite distance, a definite position within the spatial field; its perception implies a whole space-psychology. We are now dealing, however, with extent of a more primitive kind: an extent that is merely expanse, without particular form, without recognised magnitude, without relation to other extents, neither near nor far, — an extent that is present as extended, and that is all. We can, perhaps, get the best idea of it by closing the eyes and observing the dark field: here is an outspread of black, or of dark red, but it is an outspread with no definite size or shape, and it lies neither on the eyeballs nor out in space. We get an approximation to it when we open the eyes in a completely dark room, or face a bank of thick fog, or gaze through half-shut lids at the blue sky, though in these cases the effort to abstract from what we know of space is greater and oftentimes less successful.

We may imagine, then, that the untrained eye sees the landscape as we ourselves see the field of the closed eyes. But the landscape is not uniform: there is usually a marked difference between what is above and what is below the horizon; and the lower portion is variegated, made up of patches of colour which, at least in many cases, contrast with one another. The landscape is also, to a certain degree, in movement: clouds travel across the sky, and living creatures move about beneath the sky. Visual expanse, as the world of spatial stimuli is constituted, thus contains within itself the cues to localisation; colours are not only spread out, but they are also spread out here and there, spread out now here and now there. The perceptions of form and magnitude, and the perception of place or position, have their root in one and the same datum of extent.

Psychology has, unfortunately, been occupied rather with theories of the origin and growth of space-perception than with the introspective study of psychological space itself. And we find, accordingly, the most radical disagreement among authorities. At the one extreme stand the statements that a certain roominess or volume "is discernible in each and every sensation, though more developed in some than in others,"<sup>1</sup> and that "the accompaniment of a local sign or local characteristic is common to all sensations";<sup>2</sup> at the other, the statement that spatiality cannot be "an original attribute of the elements themselves, in any such way as intensity and quality of sensations are original attributes"; space implies the "arrangement of sensations," so that a sensation with a spatial attribute is "psychologically impossible."<sup>3</sup> The position taken in the text lies between these extremes. It grants

<sup>1</sup> W. James, *Principles of Psychology*, ii., 1890, 135. We recur to the question of the third dimension in § 86; cf. *supra*, pp. 51, 94 f.

<sup>2</sup> M. von Frey, *Die Gefühle und ihr Verhältnis zu den Empfindungen*, 1894, 12.

<sup>3</sup> W. Wundt, *Outlines of Psychology*, 1907, 114.

to some sensations an original character of spatial outspread, and it makes localisation of these sensations a necessary consequence of qualitative differences within the total bidimensional field.

What sensations, then, have the attribute of extent? From his own introspection, the author would reply, without hesitation, that visual sensations and sensations of cutaneous pressure are spatial, and that sensations of hearing and of smell are spaceless. He inclines to believe, further, that the other cutaneous sensations (warmth, cold, pain), the organic pressures and pains, and all the sensations of the kinaesthetic senses are endowed with the spatial attribute, although they play parts of very varying importance in space-perception. Experiments on this matter are sorely needed; in particular, it seems impossible to say, from unaided observation, whether the taste-qualities are extended or whether their spatial appearance is due to concomitant pressure. || Note  
Title  
  
x N.B.

46  
11-172  
A psychological field of space, a varied mental expanse that compels localisation, is furnished primarily by eye and skin (§§ 30, 50); the two organs whose physical extent lies open to the simultaneous operation of a number of spatial stimuli. How it comes about that the sensations from these sensitive surfaces are ordered and arranged in correspondence with their external stimuli, we do not know. The suggestion has been made that the arrangement is, in the last resort, a matter of habit: like impressions usually come together and are thus approximated in perception; unlike impressions usually come at a distance from one another and are thus separated in perception. Not only, that is, do qualitative differences within the total field give the general cue to localisation, but the running together of like qualities and the holding apart of

diverse qualities is also, in itself, localisation of a primitive and undeveloped sort. However this may be, the original psychological fields are those of sight and pressure. The visual field is the more homogeneous; indeed, it has been doubted whether the skin ever supplies a single field,—whether it does not rather give a number of heterogeneous, partial, though partially overlapping fields. Yet if you observe yourself, not too analytically, as you lie comfortably in bed, breathing easily and free from organic disturbance, you may get the impression of a flattened, bidimensional field of pressure, astonishingly indefinite in form and size, but still unitary and single.<sup>1</sup>

§ 86. **The Third Dimension.** — How, now, do we acquire the perception of depth, of distance away from us, of a third spatial dimension? This question must be asked and answered separately for the two great groups of spatial sensations, the cutaneous and the visual.

(1) *Tactual Space.* — In its first form, then, our question runs: Could an organism, of like origin and descent with man, but lacking eyes, perceive all three of the dimensions of space? And the answer seems to be that it could: primarily, because the skin can move, in all three objective dimensions, both upon external objects and upon itself. The blind organism of which we are speaking is, by

<sup>1</sup> Stumpf raises the question (*Ueber den psychologischen Ursprung der Raumvorstellung*, 1873, 283) whether an observer who is entirely naïve in matters of space-perception—as he puts it, a new-born baby—would perceive the pressure of a finger run round his body as a straight line or as a ring. Stumpf thinks that he would perceive it as a ring of pressure in three dimensions; Ebbinghaus (*Grundzüge der Psychologie*, i., 1905, 453) that he would get a large ring in two dimensions. The author, in the light of his own experiences of an unitary field of pressure, is disposed to believe that the perception would be that of two closely apposed lines (possibly fusing at their extremities), or perhaps of a single broad line, traversed in opposite directions.

hypothesis, a moving organism. Hence the bidimensional field of pressure, which forms its stationary equipment of spatial consciousness, will be transformed into a bidimensional field of active touch; some preferred part of the skin — hand, finger-tips — will be used for the exploration of external objects; and as, in all such movement, the cutaneous impression is connected with complexes of articular sensations, the right-left and up-down dimensions will be reduced in consciousness to a common spatial denominator, and will be represented in terms of the sensations aroused by movement. But the organism has freedom of movement in the third or back-forth dimension as well; so that it gains a third set of experiences, of the same general kind as the other two, and yet distinguishable from them; it learns to perceive depth or distance away.

The shift of spatial emphasis from skin to joint, from cutaneous to articular pressure, would hardly be possible unless, as we suppose, the articular sensations are themselves spatial in character. The general transition, from bidimensional to tridimensional space, must be favoured by the organism's ability to move and fold the skin upon itself: arms and legs may be crossed; the hand may be passed around as well as across the head or leg or arm; or the one hand may explore, in any direction, an object held by the other hand against the body. Moreover, the total movements of the organism, movements of locomotion, involve the third dimension of objective space; and their conscious representation may be derived, not only from the skin and the complex of joint, tendon, and muscle, but also from the kinaesthetic organs of the inner ear.

We have spoken as if the three dimensions of space were, in the world of stimuli, sharply distinct. In reality, they are conventional.



It is possible to draw, through a given point, only three straight lines that lie at right angles to one another; and it has proved convenient to work out the science of geometry on the basis of this threefold system of coordinates. In the same way, it is convenient, when we are dealing with space-perception, to think of the organism as set in a space of three dimensions; and it is natural to consider two of these dimensions, the vertical and the horizontal (up-down and right-left), as lying in a frontal plane, and the third, the dimension of distance (back-forth), as lying in a sagittal plane. But the organism itself need know nothing of geometry; in perceiving the third dimension, it simply perceives objects as near or remote. And it must be remembered that the dimensions change, psychologically, with every change of front executed by the organism: turn to your left, and what was length becomes distance; lie on your back, and what was height becomes distance. This constant interchange of objective dimensions has undoubtedly helped towards the perception of tridimensional space.

At any rate, our view is that this perception of a third dimension is due to analogy. The two original dimensions of cutaneous space are translated into characteristic complexes of articular sensations; and a third characteristic complex of articular sensations gives rise — by help of the skin's movement upon itself — to a third perceived dimension. It is in some such way that the congenitally blind achieve their direct perception of a tridimensional space (§ 90). They are, however, at a disadvantage as compared with our imaginary organism; for the central nervous mechanism which in man subserves space-perception is essentially a visual mechanism; sight-space dominates touch-space; and the human being who is deprived of sight is therefore deprived of much more than his eyes; he loses also no small portion of his brain.

(2) *Visual Space*. — If you fix your eyes steadily upon some object in the field of vision, — a tree, let us say, seen through the open door, — the surrounding objects appear in their proper shapes and places; the space-values of the field are entirely normal. But if, now, you hold up a pen-

cil, at arm's length, between the eyes and the point of fixation, you find that it doubles, that you see two pencils. And if, after this experience, you consider the field of vision somewhat more carefully, you will find that it shows a good deal of doubling: the tip of the cigar in your mouth splits into two, the edge of the open door wavers into two, the ropes of the swing, the telegraph pole, the stem of another, nearer tree, are all doubled. So long, that is, as the eyes are at rest, only certain objects in the field are seen single; the rest are seen double.<sup>1</sup> The images of the former fall upon what are called corresponding retinal points; those of the latter upon non-corresponding or disparate points.

Think of the two retinas as slipped, the one over the other, and as held together by a pin driven through the superimposed foveas (p. 88). The two pin-holes then represent corresponding points, the retinal points stimulated by the point in objective space which the eyes, at any given moment, are fixating. Let other pins be driven, vertically, through the two retinas, at any points round about the fovea: in the rough, every pair of pinholes will represent a pair of corresponding points. Now it is clear, if you work the matter out by help of diagrams, that, when the eyes are in a certain fixed position, only a certain number of the points in objective space can be imaged upon corresponding retinal points. The sum-total of these, singly seen and correspondingly imaged, objective points is called the horopter. If, for instance, the eyes are directed straight forward to the horizon, the

<sup>1</sup> Our habitual disregard of double images is one of the curiosities of binocular vision. It is due in part to the fact that the eyes are in constant movement, so that the various objects in the field are successively fixated; in part to the indefiniteness of indirect vision (p. 83); in part to the suppression of the one or the other image by retinal rivalry (p. 320). Apart, however, from these peripheral factors, it is due, perhaps mainly, to cortical set or adjustment; we mean, expect, are disposed to see singly things that are objectively single. Cf. pp. 274 f., 464.

horopter may be a plane surface which is practically identical with the surface of the ground upon which the observer stands ; if they are directed upon a point at finite distance in the median plane, it may consist, in theoretical construction, of a horizontal circle which passes through the two eyes, and of a vertical straight line which lies in the median plane and passes through the fixation-point.



FIG. 45. Horopter Model, showing the horopter as a horizontal circle and a vertical through the fixation-point.

Suppose, now, that the images of some object in external space fall upon retinal points that are almost, but not quite, in correspondence. The object is seen as single ; for the corresponding points are not points in the mathematical sense ; a point on the one retina corresponds to a small area on the other. Suppose, again, that the images fall on retinal points that are just a little further removed from correspondence. The object is still

seen as single ; but it is now seen as extending in the third dimension. That is to say, tridimensional vision, the vision of the object as solid, is a sort of halfway house between single and double vision ; to see a thing solid is a compromise between seeing it as spatially one and seeing it as spatially two.

But why should this combination of disparate retinal images take place at all? Why should not disparity of

images mean, at once and always, that we see the object double? These are difficult questions; and we can no more answer them, in any ultimate sense, than we can say, for instance, why light of a certain wave-length is seen as red and not as blue. But we can at all events give a proximate answer; we can show under what conditions the combination of the disparate images is effected. Human vision is binocular vision; the two eyes work together as a single organ. Now the two eyes are like two separate observers, who view the objects in the spatial field from somewhat different standpoints; so that, within certain limits of distance, the one eye sees a given object somewhat differently from the other eye (binocular parallax). There can be no cooperation between them unless their separate views are reconciled and combined; and reconciliation is, consists in, tridimensional vision.

Draw upon a piece of transparent celluloid the two pairs of vertical lines shown in Fig. 46. Let the distance between the left-hand members of the pairs be 64 mm.; this is the average interocular distance, or distance from centre to centre of the pupils when the eyes are directed straight forward to the horizon.<sup>1</sup> Look steadily at some distant point, and bring up the transparent slide before the eyes, in such a way that the middle points of the left-hand lines fall upon the foveas. These two lines are then imaged upon corresponding points, and are seen as one line. The right-hand lines are imaged upon disparate points; they are, however,

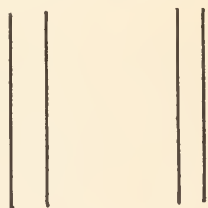

FIG. 46.

<sup>1</sup> It would, perhaps, be better to say the 'conventional' than the 'average' interocular distance, since a distance of 64 mm., though commonly given as the average, is probably somewhat too high (Nagel's *Handbuch d. Physiol.*, iii., 1905, 292). It is best of all to make the measurement afresh in every individual case (Titchener, *Exper. Psychol.*, I., ii., 1901, 245).

seen as a single line, standing nearer to you than the other. The combination of disparate images gives the perception of depth.—Now, if you hold up two pencils before the eyes, that in the left hand at arm's length, that in the right a little to the right of the other, and a little nearer; and if you observe the pair of pencils first with the left and then with the right eye alone, you will find that the left-eye view is represented by the left-hand pair of lines in the figure and the right-eye view by the right-hand pair (binocular parallax).

Draw upon another slide the pair of lines shown in Fig. 47. Look at a distant point, and bring up the slide in such a way that the middle points of the two lines are imaged on the foveas. You see a single line, the lower half of which stretches away, while the upper half inclines towards you. Set up a pencil in this position, and note the images formed in the two eyes.

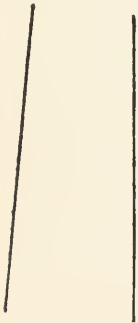

FIG. 47.

Disparity of retinal images thus accounts for the fact that an object in external space is seen as solid. But the object is also seen as distant from oneself, as lying so many metres away: the point fixated is localised in the third dimension, just as definitely as the points imaged on disparate retinal areas. How do

we localise the fixation-point?

It is possible, of course, that we localise it, too, in terms of retinal disparity. What is now the point of fixation, imaged on corresponding retinal points, has been in the past, and will be in the future, a point that is imaged on disparate retinal points: that is to say, it has been and will be localised, by retinal disparity, in relation to other fixation-points. In time, then, every point in objective space will acquire what we may call a relative position in visual space; and it is a well-known law of psychology that the frequent occurrence of a relative character tends to transform it, for

perception, into an absolute character; we speak in absolute terms of a heavy child, a light travelling bag, a strong voice, a good light, without any conscious reference or comparison. The transformation might be greatly assisted, in the case of visual space-perception, by associations derived from tactual space: what we can easily reach would be seen as absolutely near, and so on. Or again, it is possible that we localise the fixation-point by the help of secondary criteria. On the whole, however, it seems probable that absolute localisation is effected by way of muscular sensations, the sensations aroused by movements of accommodation and convergence.

The indirect or secondary aids to localisation in depth may be summed up as follows: linear perspective, the course of contour lines in the field of vision; aerial perspective, relative clearness of outline and distinctness of hue; the distribution of light and shade; interposition, the partial covering of far by nearer objects; apparent magnitude, — a criterion that is especially valuable in the case of familiar objects; movement of objects in the field of vision; and movement of our own head or body: if we fixate a near object, and move the head to one side, distant objects show a movement in the same direction; if we fixate a far object, and move the head as before, nearer objects show a movement in the opposite direction. No doubt all of these aids have had their share in the formation of our visual space-perceptions; but it is questionable whether any one of them is essential.

A like question may be raised with regard to eye-movement: it is, in fact, a matter of keen controversy whether the movements of accommodation and convergence are constitutive factors in space-perception, or whether they are, like the movements of head and body, of merely secondary importance, — *e.g.*, as aids to fixation. On the physiological side we have the fact that the two eyes form a single motor organ; they move together, automatically, under all the conditions of a possible fixation. If the fixation-point is very



remote, and lies in the median plane, the lines of regard are parallel ; and they remain thus parallel for remote fixation at any part of the field. If the fixation-point lies nearer, in the median plane, the lines of regard become symmetrically convergent ; the eyes, which before were directed straight forward at the horizon, turn inward through equal angles. If the new fixation-point does not lie in the median plane, the lines of regard become asymmetrically convergent ; in this case, either the two eyes turn inward, through unequal angles, or the one eye turns in while the other, through a smaller angle, turns out. These two types of convergence are maintained, again, for the fixation of points at any part — up, down, right, left — of the field of vision. In short, wherever the eyes can act together, for purposes of binocular vision, they do act together ; and the one thing that they cannot do is to act separately against binocular vision ; it is impossible, with normal eyes, for the lines of regard to diverge.

On the psychological side we have a long series of experimental studies, whose results are not easily harmonised. Psychological opinion is, in the main, unfavourable to the connection of the depth-perception with sensations of eye-movement ; and it must be granted that our discrimination of distance is far more delicate than we should expect it to be, were it mediated solely by muscular sensations. Nevertheless, it seems certain that these sensations can furnish the data for localisation. Recent experiments, carried out with all precautions, lead to the conclusion that in monocular vision the sensations of accommodation, and in binocular vision the sensations of convergence, give fairly accurate cues to the position of objects in external space. The sensations are not always discoverable by introspection ; the perception of distance may come to consciousness directly. This, however, is not surprising ; space is so familiar to us, and the cortical set or adjustment for the perception of space must be so entirely habitual, that the immediacy of the spatial attitude is only natural ; the surprising thing is, rather, that the sensations in many cases are discoverable, that the peripheral cues do persist in consciousness. At the same time it must be remembered that sensations of movement, in vision as in touch, are only secondarily, by analogy, the source of our perception of the



third dimension; they are, as we have put it, cues to this perception. They may get their spatial significance either from the relative depth-perception due to disparity of retinal images (if that is regarded as primary), or by a more direct association with the tridimensional space of touch.

There is, as we have intimated above, a monocular perception of depth. One-eyed persons have no difficulty in finding their way about; and we ourselves, if we close one eye, suffer from no illusion as to the solidity of the objects around us. In all such cases, the observer can change his position with regard to surrounding objects; the objects themselves may change their positions, with regard to him and to one another; and various other secondary criteria of distance are still available. As direct cues to the perception of depth there are, first, the sensations of accommodation already mentioned; and secondly, within certain limits,—though this factor has been disputed,—the parallax of indirect vision: the relative position of the retinal images of objects seen by the same eye in indirect vision changes, if accommodation is changed, or if the eye or the object moves; and it is supposed that this shift of position may play a part, in monocular vision, similar to that played in binocular vision by the disparity of retinal images. But, whatever its resources may be, monocular localisation is normally very far from accurate. If a curtain ring is suspended in the median plane of the observer's body, and he is given a pencil and required, with one eye closed, to thrust the pencil through the ring, the pencil will pass at surprising distances before or behind it.<sup>1</sup>

All the direct criteria of depth-perception have a limited range of effectiveness. Accommodation can hardly come into account for objects more than 2 m. away, and the parallax of indirect vision is of appreciable importance only for objects that lie at arm's

<sup>1</sup>You may often see connoisseurs looking at a picture monocularly, through the curved hand. The hand serves as a tube, whose walls shut out distracting impressions. The main advantage of monocular vision is that the plane of the picture is less evident to it than to binocular vision, so that the secondary indications of distance, upon which the artist must rely for his depth-values, have a better chance to produce their effect.

length in the lower portion of the field of vision. Convergence, if experiments are to be trusted, becomes useless at a distance of 15 to 20 m. Retinal disparity may work, in theory, up to a distance of some 2700 m. (p. 325): but in practice it is replaced, long before this point is reached, by the indirect or secondary criteria of the depth perception.

§ 87. **The Stereoscope.**—If the visual perception of depth is due to disparity of the retinal images formed by a single object, then the conditions of tridimensional vision can be synthetised, artificially reproduced, without our having recourse to more than two dimensions of objective space. For the two slightly different pictures taken by the two retinas are plane pictures, and not themselves solid facsimiles of the object. Suppose, then, that we make on paper two drawings of one and the same thing,—a figure of the thing as it looks to the right eye, and a figure of it as it looks to the left,—and that we present each drawing to its appropriate eye. The two drawings, reversals of the two retinal images of a single object seen in perspective, must combine to form the representation of such an object; that is, they must give us the illusion, or rather the synthesis, of the third dimension. They do, in fact, combine in this manner; they show what is called stereoscopic relief. The experiment may be performed in a great variety of ways: there are, however, two instruments that have an especial importance,—Wheatstone's reflecting stereoscope and Brewster's refracting stereoscope.

An early form of Wheatstone's stereoscope is shown in Fig. 48. Two plane mirrors, into which the two eyes look, are so adjusted that their backs form an angle of  $90^\circ$ . The diagrams slip into grooves in two vertical panels, which move in and out on slides

along two flat wooden arms. The arms themselves turn about a common centre, which lies in the projection of the line of junction of the mirrors. The rays reflected from the mirrors fall upon the eyes as if they came from a single solid object immediately in

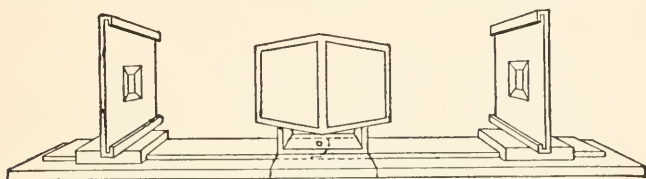

FIG. 48. Wheatstone's Reflecting Stereoscope. — C. Wheatstone, *Phil. Trans. of the Royal Soc. of London*, 1852, pt. i., 3.

front; or, in other words, the eyes see the combined (virtual) image of the two figures as if through and behind the mirrors.

The manipulation of the instrument is simple. The diagrams to be combined are slipped into the grooves. The arms are set in the same straight line, and the slides are pushed well out upon them, at equal distances from the mirrors. The panels are placed at an angle of  $45^\circ$  to the mirrors. The observer sits, looking into the mirrors, and slowly moves the ends of the arms outwards, away from him, until the images combine. Seen for the first time, the stereoscopic effect is surprising in its tridimensional reality.<sup>1</sup>

Brewster's refracting stereoscope, although scientifically a less valuable instrument, has by its cheapness and compactness driven

the reflecting stereoscope out of general use. In its modern form, the stereoscope is furnished with a light wooden hood, fitting

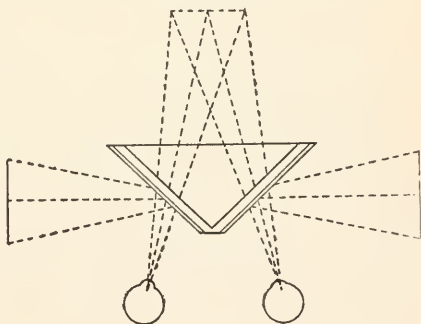

FIG. 49. Plan of Wheatstone's Stereoscope.

<sup>1</sup> It must be remembered that the use of mirrors involves a left-right conversion of the stereograms.

closely over forehead and nose, which serves to exclude lateral light.<sup>1</sup> The eyes look at the stereograms through lenticular prisms (double convex semi-lenses): the prisms bring it about that, despite the convergence of the lines of regard, the stereograms are imaged on the retinas approximately as if the lines of regard were parallel; the rounding of the prism-surfaces renders the binocular image both larger and more distinct than it would otherwise be. The long bar, upon which the stereographic card slides, allows of the adjustment of the carrier for eyes of different

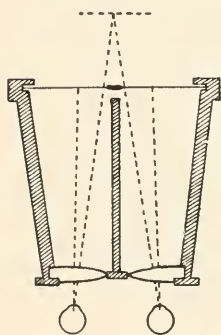

FIG. 50. Plan of Brewster's Refracting Stereoscope, old model. — D. Brewster, *The Stereoscope, its History, Theory and Construction*, 1856.

focal lengths. The stereograms usually supplied with the instrument are paired photographs, taken by cameras whose lenses are — or should be — separated by the average interocular distance. If the cameras are set still farther apart, the binocular (enlarged, virtual) image shows an exaggeration of perspective, and the landscape or building seen in relief has the appearance of a model.

It might be supposed, at first thought, that the stereoscope would settle the controversy regarding eye-movement (p. 313). There are, however, various reasons why it cannot. For one thing, it does not permit of a rigorous control of the conditions of observation; the secondary criteria of distance can never be entirely ruled out. Thus it is possible, in the Wheatstone stereoscope, to vary the degree of convergence while the magnitude of the retinal images remains unchanged (this by pushing the arms still farther out, after perspective vision has been attained, and then by bringing them back again into the same straight line), and to vary the size of the images while convergence remains unchanged (this by moving the slides in and out, nearer to and farther from the mirrors); but the chief result — in the first case, change of apparent magnitude of

<sup>1</sup> The hood-stereoscope was devised by O. W. Holmes in 1861.

the binocular image ; and in the second, change of its apparent distance — proves very clearly that the perception is largely determined by cortical set ; the observer is influenced by his knowledge of tridimensional space. For another thing, though we may exclude eye-movement proper, we can never exclude the motor dispositions of the eye ; and these, on the eye-movement theory, may take the place of movements actually performed. N.B.

Figure 51 shows a simple instrument which embodies the principle of three more special apparatus. It consists, besides rods and

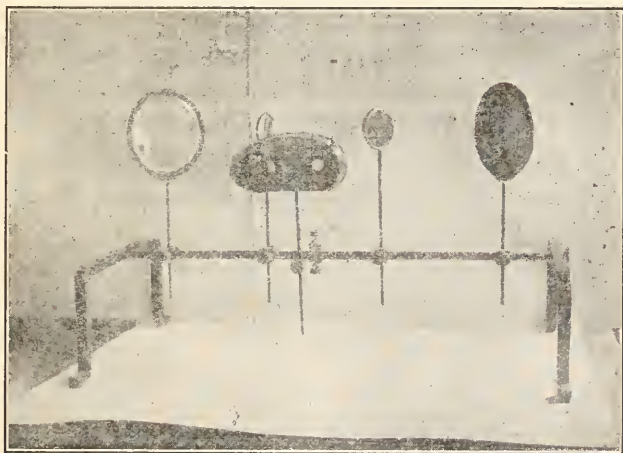

FIG. 51. Demonstrational Stereoscope, Telestereoscope and Pseudoscope.

clamps, of the hood of a refracting stereoscope (with the prisms removed), two hand-mirrors, and two pocket-mirrors. If stereograms are placed in clips at the back of the hand-mirrors, we have a Wheatstone stereoscope. If the instrument is set on a windowsill, with the hand-mirrors parallel to the pocket-mirrors and facing the landscape, we have Helmholtz' telestereoscope: the interocular distance is, to all intents, increased to the distance between the large mirrors, and the perception of depth is enhanced. Finally, if the left-hand small mirror and the right-hand large mirror are thrown down, and the remaining mirrors set, facing each other, at an angle of  $45^\circ$  to the median plane of the observer, we

have Stratton's form of Mach's mirror pseudoscope: the left eye looks directly at its object, while the right eye sees the same object twice reflected; hence the right eye is, so to say, displaced to the left of the left eye, and the distance-relations of the object are inverted; near becomes far, and far, near.

*Retinal Rivalry and Binocular Colour-mixture.*—So far, we have used the stereoscope for the combination of disparate images of a single object. We may also employ it for the imaging of different objects upon corresponding retinal areas. What happens, if we present to the two eyes pictures of identical shape, size, and position, but of varied content?

By far the most frequent result is the phenomenon known as retinal rivalry. Cut a card to the size of a stereoscopic slide (refracting stereoscope), and paste on it, at the right distance apart, two 1-cm. squares of red and green paper, the one crossed by vertical and the other by horizontal black lines. Try to combine the two images in the stereoscope. You will find that they oscillate: now the red and now the green will appear; now the one colour will seem to hang, like a translucent veil, before the other; now a patch of the one will give way to the other, which spreads gradually over the whole square. A steady binocular image is not obtained. Whether the one or the other image can be held by the attention (which, in this case, means the cortical set underlying the observer's intention to see red or to see green, and the eye-movements aroused in the effort to hold, follow, or find a disappearing image) is a matter of dispute. It seems, however, that long practice may overcome the rivalry; for expert microscopists rarely close the unoccupied eye while they are observing.

Under certain conditions, the phenomenon of retinal rivalry is replaced by that of binocular lustre. Suppose that you are looking at a dead-finished surface, which is smooth over its whole extent, but is not quite even: then the one eye may be in the direction of the reflected light, so that to it the surface looks bright, while the other may not be in this direction, so that to it the surface looks dull, or shows the reflection of some coloured object. Such a surface, seen in ordinary binocular vision, appears lustrous. If,



then, we place in the stereoscope two pictures of the same object, the one white and the other coloured, — still better, if the one is white and the other black, — we shall get the perception of sheen or lustre. The binocular image of Fig. 52 does, in fact, show a graphite-like polish, although, for most observers, traces of rivalry also persist.

Lastly, the phenomenon of rivalry may be replaced by that of a binocular colour-mixture.

The existence of this mixture has, again, been keenly disputed, but there can be no question of its occurrence. In the author's experience, the best way to secure it by aid of the stereoscope is to combine two small fields of dull and unsaturated colour. The

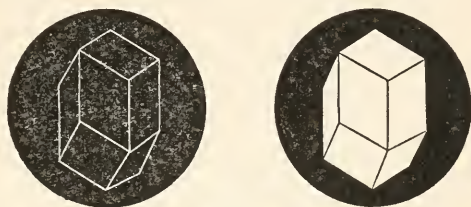

FIG. 52.

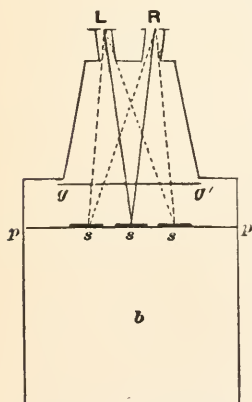

FIG. 53. Hering's Binocular Colour Mixer. L, R, the two eyes; *b*, dark box; *gg'*, coloured glasses (red and blue); *pp*, supporting plate of clear glass; *sss*, squares of white paper. — Hermann's *Hdbch. d. Physiol.*, iii., I, 1879, 593.

paper squares must be pasted with extreme accuracy upon the cardboard slide; and the observation should be made with the images a little out of focus, so that the contours of the fields are blurred. Some observers, however, succeed most easily with identical contours of considerable complexity: trials may be made with differently coloured postage stamps. Where the mixture is attained, the resultant colour is the same as in ordinary colour-mixture, but its brightness is the mean of those of the combined colours.

§ 88. **The Perception of Space: Locality.** — Our visual perception of place or position is very highly organised; stimuli that are distinguished as spatially different, in daylight vision, are also definitely



placed in relation to one another.<sup>1</sup> With the skin it is otherwise; the cutaneous perception of locality is less developed; and we are able, in the course of a single experiment, to bring out various modes and degrees of localisation. Suppose, for instance, that a pair of compasses, having delicately rounded points of hard rubber, is set down upon the skin of the forearm, with the points 1 mm. apart. We perceive, with eyes closed, a single, sharp pressure upon the forearm. Localisation may be effected in several ways: we may feel an impulse to move the hand of the opposite side towards the part touched, or we may have a visual picture of the arm and of the point resting upon it, or the pressure may touch off at once some form of words ("Halfway up the arm, in the middle"). The visual picture and the words are, of course, secondary criteria of cutaneous position, and the feel of the localising movement, though much more nearly primitive, is also, if we may trust the conclusions of § 85, in the last resort of secondary character. Here, then, is what we may call the absolute perception of cutaneous locality, the perception of the position of a single pressure. Now let us consider the relative perception: let the compass points be gradually separated, by small steps, and let us note the results. We get, first of all, a larger, blunt point; this gradually passes into a small surface of oval form: then comes a thickish line; then the perception of two sharp points, with a faint linear connection between them;

<sup>1</sup> This statement is true as a first approximation to the facts. We ought, by rights, to take account of indirect as well as of direct vision, of vision of luminous points in the dark as well as of vision in the daylight, of pathological states of the retina, of the action of the ocular muscles in normal and abnormal conditions, of the position of the head. But if all the details were discussed, the psychology of space-perception would require a large book to itself!

and then the two points stand out separate and distinct. But all this while there has been no perception of the direction in which the lines or points lie; not, perhaps, till the compass-points are 25 mm. apart, can the observer say 'longitudinal' or 'transverse.' Our perception begins as that of an absolutely localised, undifferentiated, cutaneous expanse; the expanse presently shows relative spatial difference, but a difference that cannot be expressed in terms of direction; next appears the indefinite perception of spatial duality, of two disconnected extents; and, finally, the relation of these extents becomes definite, and the perception of relative or directional position is complete.

The testing of the skin by means of the aesthesiometric compasses is one of the oldest psychological experiments. E. H. Weber (p. 219) published in 1834 the results of an exploration of the entire bodily surface; he found that the perception of spatial difference is keenest for the tip of the tongue and fingers, dullest for the upper arm, thigh, and back. Weber supposed that he was thus measuring the space limen, the just noticeable magnitude of cutaneous space. In fact, however, there is no necessary relation between spatial duality (difference of localisation) and spatial magnitude (extension, length of line between points). The discrimination of magnitudes, with or without the perception of direction, is a subject for special investigation. We discuss it in the following § 89.

If two juxtaposed pressure-spots (p. 146) are stimulated at one and the same moment, the pressure sensations blend, to give a single, stronger sensation; there is no spatial distinction. The determination of spatial duality by the simultaneous stimulation of pressure-spots is difficult, and the results are variable: they depend, not only on the tendency of the separate sensations to blend, but also on the intensity of the stimuli used, and especially on the general disposition (cortical set) of the observer. If, on the other hand, neighbouring spots are successively stimulated, at an interval of about 1 sec., their sensations are distinguished: the

difference is at first indefinite, — the pressures are different, and that is all; but after several repetitions of the observation it may become a difference of perceived position.

As regards simultaneous stimulation, the resting eye behaves in the same way as the skin. The cones have, at the fovea, an average diameter of  $3 \mu$  ( $1 \mu = 0.001 \text{ mm.}$ ). Points in space can be distinguished if the distance between them subtends a visual angle of a little less than  $1'$ , or, in other words, if the distance between their retinal images is  $4 \mu$ : this distance just leaves room for an unstimulated cone between those upon which the images are formed. Beyond the fovea, in indirect vision, the separation of ob-

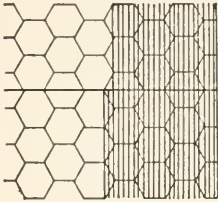

FIG. 54. A field of cones (shown schematically as hexagons) is stimulated by a sheet of half-white and half-black paper.

The sheet has been cut through along the horizontal line, and the upper portion has been shifted a trifle to the right. The black of this upper portion now leaves unstimulated cones which are still affected by the black of the lower portion. Hence the displacement is perceived. — E. Hering, *Ber. d. math.-phys. Klasse d. k. sächs. Gesellschaft d. Wissenschaften*, li., 3, 1899, 16.

jective points necessary to their separate localisation rapidly increases. Whether juxtaposed cones give the perception of local difference when successively stimulated, the author does not know.

If the resting eye is required, not to distinguish points in space, but to note the relative displacement of lines or edges of surfaces, localisation is far more accurate. Two straight lines placed end to end are perceived to lie apart under a visual angle of only  $5''$ , or, in other words, when the distance between their retinal images is less than  $0.5 \mu$ . The most probable explanation of this fact is given in Fig. 54.

Precisely the same disparity of retinal images is sufficient, in binocular vision, to give a noticeable difference of depth. The classical experiment is as follows: three fine needles are set up, in the transverse plane, at a short distance from the eyes; the two outer needles are fixed in position, while the middle needle is moved, in successive observations, back or forth in the median plane, until the difference in depth is remarked. In a particular case (interocular distance, 66 mm.), the needles were 0.7

mm. in diameter, and were set up 3 mm. or 5' apart at a distance of 2 m. The limen of depth was reached when the middle needle was moved 1.5 mm. toward or away from the observer. This amount of displacement means a difference of 5'' in the position of the retinal images of the two eyes.<sup>1</sup>

*The Law of Identical Visual Direction.*—The intimate cooperation of the two eyes in binocular vision is well shown by the following experiment. Place yourself before a window from which you can see, in the distance, two salient objects—say a tree and a chimney—not too far apart. Make an inkspot on the window, for a fixation-point, and stand in such a position that the spot, fixated by the one eye alone, covers the tree, and fixated by the other eye, without change of the position of the head, covers the chimney. Now fixate the spot with both eyes; you see the tree and the chimney—in rivalry, of course—directly behind the fixation-point. Inkspot, tree, and chimney have the same direction, lie in the same straight line; and this line, if prolonged to the observer's face, would pass between the eyes, or, as Hering puts it, would strike the fovea of a single, cyclopean eye, set midway between the actual eyes.

*Internal Localisation.*—A special question which belongs to this Section is that of internal localisation (§ 57). How do we localise the organic sensations? It may be noted, first, that if the sensations are at all intensive there is a tendency to move the hand over the skin of chest or abdomen. Whenever this exploratory pressure sets up, diminishes, enhances, or puts an end to an internal sensation, a cue to localisation is given. Secondly, however, certain organic sensations are regularly connected with other localised sensations. Thus, hunger and intestinal pain may get their place-reference from attendant contraction of the diaphragm, or from distension and contraction of the abdominal wall; stuffiness

<sup>1</sup> The further limit of depth-perception, the limit beyond which no difference of depth can be perceived in terms of retinal disparity, lies at the point at which the interocular distance itself is viewed under the smallest visual angle that permits of depth-discrimination. As the average interocular distance is taken as 64 mm., and the visual angle in question is 5'', the limit must be placed, approximately, at 2700 m. (p. 316).

and exhilaration may be referred to chest or head through associated contractions of the chest muscles, or constriction and relaxation of the nasal passages and respiratory entrances. Here would fall, also, the cases of reflex reference (pp. 184, 186). Thirdly, in minds of visual constitution, organic sensations are directly localised by help of visual images. The author has a definite mental picture of the course of a draught of cold water through the alimentary canal, though he must confess that the picture is accurate neither in scale nor in directions. Visual association is probably responsible, also, for the general tendency to localise organic sensations towards the front of the body (p. 187). Altogether, then, organic localisation is an indirect affair, due to palpation, to connection with localised sensations, to visual associations, and influenced, no doubt, by more or less accurate knowledge of the position of the principal organs of the body.

§ 89. **The Perception of Space: Magnitude.**—The cutaneous perception of magnitude may be determined either by linear stimuli or by point-distances. It is especially interesting to compare point-distances at different parts of the body. If the one distance is kept constant, and the other varied from observation to observation, we shall presently arrive at subjective equality: it has been found, for instance, that a distance of 5 mm. on the finger-tip is the equivalent of a distance of some 16 mm. on the wrist. In general, as this instance shows, point-distances are perceived as larger at parts of the skin which have the more delicate discrimination of locality; so that the points of a pair of compasses, drawn across the face above and below the lips, or drawn down the inside of the arm from shoulder to finger-tips, seem to diverge and converge according to the local sensitivity of the regions traversed. There is, however, no direct proportionality between the two perceptions. Moreover, if the point-distances are relatively large, local dif-

ferences tend to disappear, and subjective tends to coincide with objective equality. Here we have evidence of the dominance of visual over cutaneous space; vision has informed us of the actual size of the areas stimulated, and we equate the stimuli by what we know rather than by what we feel.

Very many experiments have been made upon the comparison of point-distances by the eye. The results show that, at any rate for stimuli of a middle range of magnitude, the differential limen is always the same fraction of the distances compared; in other words, the visual perception of magnitude obeys Weber's Law. Hence it is natural to suppose (and, indeed, there is introspective warrant for the hypothesis) that the distances are compared in terms of the sensations aroused by eye-movement; the greater the intensity of these sensations, the greater is the distance for perception (p. 219).

It is worth remarking that we get differences of perceived extent by the stimulation, at various intensities, of a single pressure-spot, and of a single retinal cone. Further: we have two cutaneous limens, for the perception of linear magnitude, whether we work with linear stimuli or with point-distances; for the perception of linear extent, as such, appears earlier than the perception of its direction upon the skin.

*The Perception of Form.* — The cutaneous perception of form is, in general, very inaccurate. At the parts of greatest local sensitivity we find small liminal values: thus, the end of a glass tube pressed down upon the tip of the tongue or of the middle finger will be perceived as circular if the glass is 0.5 mm. thick and the outside diameter of the tube is 2 or 3 mm. There can be little doubt, however, that this perception is indirect, based chiefly upon visual association.

Contour lines are followed most easily by the eye if they are continuous, by the moving finger (active touch) if they are broken.



You may test the latter statement by trying to read, with the finger-tips, two sentences, the one printed in ordinary raised print, the other in the dotted blind-print.

*The Blind Spot.* — The blind spot (p. 88) does not interfere with our perception of visual magnitude; points whose retinal images lie on either side of it do not run together, but retain their normal separation. Two factors appear to have contributed to this result. First, there is no blind spot in binocular vision; the part of the combined field to which the one eye is blind is seen by the other. But secondly, and more importantly, the eyes are

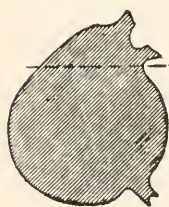

FIG. 55. Blind Spot of the author's left eye, plane projection. Reduced from a large diagram, in which the distance from the inner edge of the fixation-mark *a* to the inner edge of the blind spot was 54.5 cm. The distance of the fixation-mark from the eye, in the experiments, was 2.2 m.

constantly in motion; and the moving eyes give us the perception of spatial continuity. Primarily, therefore, points are localised and magnitudes are estimated in direct vision, and the habit of direct vision — save under special experimental conditions — is carried

over to indirect vision. Our habitual disregard of double images (p. 309) is a fact of the same kind.

As to what happens at the blind spot itself, opinions are divided. Some psychologists think that the area which it occupies is filled, in the field of vision, either by irradiation from the light and coloured surfaces which surround it, or by imagination: in looking at a patterned wall-paper, *e.g.*, we carry an image of the pattern over the blank space which represents the projection of the blind spot. Others declare that the blind spot is simply and literally blind; we see nothing at that part of the field; but, if we see nothing, we cannot see a gap or blank. The field is, then, in fact, continuous, although localisation, for the reasons given above, takes account of the existence of the blind area.

It has recently been asserted that if one looks suddenly, with a single eye, at some uniform and brightly illuminated surface, one



sees the projection of the blind spot as a faint grey patch (the central grey, p. 90).

*The Various Psychological Spaces.* — Geometry and the physical sciences know of only one space, which is always and everywhere the same (p. 7). It is clear that a like statement cannot be made of psychology. We have already said something of four psychological spaces: the bidimensional fields of the skin and the resting eye, and the tridimensional spaces of active touch and of the moving double-eye. But there are incongruities, again, within these four systems, for finger-space is not back-space, and the space of direct vision is not that of indirect vision; it would, indeed, be difficult to say how many psychological spaces can be distinguished. At all events, instances of spatial conflict are not far to seek. The cavity of a hollow tooth seems larger to the exploring tongue than to the passively pressing finger; to both, it seems larger than it does to the eye. If you bite far out over the lower lip, the upper jaw seems narrow and small as compared with the tongue's report of it. The sight of the back of one's head in a mirror is—to a man, at any rate—curiously disconcerting, so different is the visual magnitude from the magnitude registered by the hollow hand.

Plainly, then, some sort of reconciliation or compromise is required. Reconciliation is possible, because the attribute of sensory extent, the fundamental spatial datum, is identical for all the spaces. A first practical step towards it is taken in the preference given to the spot of clearest vision and the spots of clearest touch, to the fovea and the finger-tips: the other spaces are usually ignored. But these two residual spaces are themselves not in accord. Which of them takes precedence of the other?

Helmholtz declares for touch. "We are continually controlling and correcting the notions of locality derived from the eye by the help of the sense of touch, and always accept the impressions on the latter sense as decisive." The author, if he were compelled to make a choice, would, despite the authority of Helmholtz, pronounce in favour of sight. In the daylight, our space world is surely, for all practical purposes, a world of space seen; and even in the dark most of us, probably, visualise our way about. Really,

however, the issue is not drawn in these terms. We build up, in course of time, a composite idea of space, partly from data of visual, partly from data of tactual experience, but more especially from what we learn of measured, physical or mathematical space. This composite idea rarely appears as a whole, clear and well-defined, in consciousness; often, indeed, the nervous mechanism, inherited and acquired, works automatically, without consciousness at all; but often, again, and perhaps as a rule, our generalised or standardised space-experiences show as a total conscious attitude (§ 138). Then, in any given case, the attitude is particularised as circumstances determine; we apply now this and now that partial and temporary standard; we may act as if on the principle that seeing is believing, or as if on the opposite principle that appearances are deceptive; we trust our eyes, or our fingers, or neither, or both. We follow the path laid out for us, not by sight or touch, but by the present trend and tendency of the cortex.

§ 90. **Secondary Spatial Perceptions.** — Odours and sounds, although they do not possess the attribute of extent, may yet be localised. They have their physical origin at some point in objective space, and if we can get any cue to this point of origin, we can place the sensations in the visual or tactual field.

Odours may sometimes be referred to a certain direction in space by a process of elimination: we get the scent if we hold the head in a certain way, and we lose it if we turn our face in any other direction. Where this direct cue fails, we rely upon intensity; we move to and fro, sniffing, in the hope that an unusually strong whiff of the odour will give us our bearings. But the quest is uncertain; the sense-organ soon becomes adapted (p. 124); and if the scent is weak, or the stimulus has had time to diffuse, localisation is impossible.

Sounds, on the other hand, are as a rule localised readily

and with considerable accuracy. Under experimental conditions, localisation appears to depend on the cooperation of three principal factors. The first of these is the relative intensity of the sound as heard by the two ears: it is difficult to distinguish front and back, in the median plane, and localisation is poor where changes in the binaural ratio are slight, *e.g.*, at the sides, in the region of the axis of the ears. The second is absolute intensity: there are characteristic differences in intensity when the sound comes from different directions. And the third is complexity: musical tones, the human voice, complex noises, can be localised far more accurately than pure tones. At the same time it is not difficult to arrange conditions, whether for monaural or for binaural hearing, such that localisation of the auditory stimulus is impossible.

We saw, in § 86, that the congenitally blind might achieve the direct perception of tridimensional space. There is, however, no doubt that they live, very largely, in the secondary space of hearing. We have the testimony of a blind author that the blind idea of space "depends far more upon hearing than upon the sense of touch," and that the tactual idea of plasticity, of solidity, is only an occasional factor in the blind space-consciousness.

It has been suggested that what is known as the 'warning sense' of the blind—their perception of the presence of some solid object in their near neighbourhood—may also be due, either directly or indirectly, to hearing. The perception may be aroused directly by the reflection of sound-waves from the surface of the object; or the auditory stimuli may react upon the kinaesthetic organs of the inner ear, and the perception may be based upon vestibular sensations which, in the seeing, are unremarked (§ 54). Since, however, the warning sense is present in deaf patients, and in patients with normal hearing whose ears are stopped, it seems that in these cases a change in temperature, or in the pressure of the air, is responsible for the perception; the sense is, in fact,

referred by the blind to the face. There is, of course, no reason to think that the warning sense is confined to a single sense-organ; cochlea, vestibule, pressure-spot and temperature-spot may all, on occasion, be pressed into the service of space-perception.

§ 91. **Illusory Spatial Perceptions.** — In a certain sense, most of our space-perceptions are illusory. Distance, for instance, very soon closes up on itself; if we try to stop, halfway, a friend who is walking down a long corridor, we shall be likely to call out before he has gone more than a third of its length; at a little distance from the eyes, tridimensional space is perceived as a shallow relief. Magnitude, too, is illusory; the size of the moon in the sky is that of a pea held close to the eyes. Form is illusory; how often do we see a square table as square? Only direction is adequately perceived. Yet we do not, somehow, think of all these things as illusions: they represent the natural and normal way in which space is perceived; we are used to them, and can correct them, make allowance for them.

There are, on the other hand, certain simple arrangements of dots and lines that yield, in perception, a result markedly different from the result which measurement would lead us to expect. These figures, grouped together under the purely descriptive name of the geometrical illusions of sight, have in recent years been made the subject of detailed study: our Fig. 1 (p. 7) has, in particular, been repeatedly discussed and variously explained. The simplicity of the forms is, in fact, misleading; explanation is very difficult; and there is no present prospect of agreement among investigators. Three types of theory have emerged from the discussion: we may illustrate them by reference to Fig. 1.

Theories of the first type explain the illusions in terms of the physiological mechanism of perception. It is possible, for example, to explain the illusion of Fig. 1 by reference to eye-movement. We are to compare the main lines of the figure, and we move the eyes along them with this comparison in view. But in the upper half of the figure the eyes are tempted to continue their movement beyond the proper point, from the shaft to the feathers of the arrow; in the lower half their movement is checked by the enclosing arrow-heads. Hence the upper vertical appears longer than the lower.

Theories of the second type declare that illusion is due to the associative supplementing of the perception; ideas are read into the figures. Thus, according to one authority, we tend, just because we are human beings, to humanise the forms about us; a column seems, according to its proportions, to stretch up easily to its load, or to plant itself doggedly under a too heavy pressure, — precisely as a man might do. So we read ourselves, or feel ourselves, into the lines of the figure; the upper vertical has room to expand, the lower is cramped and confined. The illusion of length results.

Theories of the third type emphasise our own general attitude to the object of perception. If we take the figure as a whole, we get a pronounced illusion: the large open



FIG. 56. Ebbinghaus' Swallow Figure, showing that the illusion of the Müller-Lyer Figure, Fig. 1, does not disappear if we read into it (in the sense of the second type of theory) forces that are opposed to the direction of illusion. — H. Ebbinghaus, *Grundzüge d. Psychologie*, ii., 1908, 96.

area above, and the closed diamond-shaped area below, strike the attention; we say, from total impression, that the upper vertical is the longer. If, however, we take the figure critically, analytically, limiting our attention to the two verticals and disregarding the oblique lines, the illusion is greatly reduced, and may, with practice, entirely disappear.

There is no doubt that perception may be modified both by associated ideas and by general disposition (cortical set). The

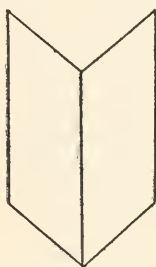

FIG. 57. Mach's Book.  
— E. Mach, *Beiträge zur Analyse der Empfindungen*, 1886, 97; *Popular Scientific Lectures*, [1867] 1895, 80.

author remembers a vaudeville performance in which a professional strong man was mercilessly hissed; the man had gilded his dumbbells, in honour of some holiday, and the audience took them for tinsel; only when he sent the mass of iron crashing through the nearest row of seats did the hissing change to applause. So with disposition; we are continually misreading the headlines of the newspapers because we are prepared, predisposed, for news of a certain sort. We may grant, then, that these factors are operative. Nevertheless, in the author's opinion, the eye-movement theory goes to the heart of the matter. It is supported by many lines of evidence, and not least by the fact that actual record of eye-movement proves the eyes to move differently according as the observer is or is not subject to the illusion. It has the further advantage of bringing into line a series of illusions known as the illusions of reversible perspective. Thus, Fig. 57 shows an open book. Is the back or the front of the book turned towards you? Fixate the middle line, or move the eyes from its extremities outward, and you see the back; fixate an outer line, or move the eyes from its extremities inward, and you see the front. And, if you think that the book reverses when you expect it or mean it to reverse (cortical set), you will find—such, at least, is the author's



uniform experience — that, as a matter of fact, the fixation-point has also shifted. All these points, however, are still, so far as detailed explanation is concerned, matters of controversy.

Page 336 contains a number of the more familiar illusion-figures; the reader should try to explain them for himself.<sup>1</sup> The cutaneous and tactual spaces show similar illusions; but the results vary greatly, both with variation of the experimental conditions and with the observer's attitude, so that no unitary principle of explanation can be offered.

§ 92. **Theories of Space-Perception.** — The psychological theories of space-perception range between two extremes. On the one side we have theories which derive, or generate, the perception of space from the intimate connection of sensations, though these are themselves considered to be entirely spaceless. On the other side we have theories which endow the individual sensation with all the fundamental spatial characters. The theory implied in the foregoing §§ 85 ff. takes a middle position: it makes extent an attribute of certain classes of sensations, regards localisation as a corollary of extent, and tries to find definite, secondary conditions for the perception of depth.

As an illustration of theories of the first class, the genetic theories, we may take Wundt's account of the origin of spatial ideas. Every point upon the skin, Wundt says, gives to its sensation of pressure, however evoked, a peculiar qualitative colouring, which may be called a local sign. But, in passing from a sensation of local sign  $a$  to one of local sign  $b$ , we experience the movement-sensation  $B$ ; whereas, in passing from  $a$  to the more different  $c$ , we

<sup>1</sup> The three squares at the top of the page are known as Helmholtz' squares; the two horizontal figures below as Oppel's lines. The large diagram to the left, below the lines, is Zöllner's pattern; that to the right is Poggen-dorff's figure. The single diagram below these is called Lipps' parallels. The broken circle to the left, at the bottom of the page, is Müller-Lyer's circle; the diagram to the right shows Müller-Lyer's semicircles.



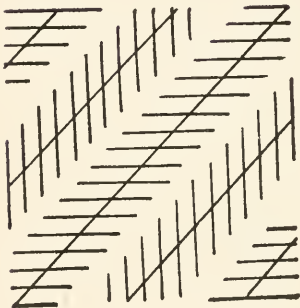
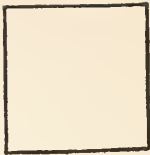

get the stronger movement-sensation *C*. The fusion of pressure-sensations and their qualitatively graded local signs with intensively graded movement-sensations furnishes, as its resultant, a bidimensional touch-space. It is then not difficult, if we grant qualitative local signs to the articular sensations, to pass to tridimensional perception. Wundt adds that the limbs tend to move in straight lines to and from objects in the field; hence the dimensions of space are naturally regarded as rectilinear. Similarly, every point upon the retina gives to its sensation, whatever that may be, a qualitative local sign, and this fuses with the intensively graded sensations of movement which serve to bring the stimuli upon the fovea: the result is a bidimensional sight-space. The perception of depth requires no additional factors. For, if the eyes move from *a* to *b* in the same transverse plane, the change in local sign and the movement-sensation are alike in both; whereas, if they move from a farther *a* to a nearer *b*, the retinal images of *a* move to the right in the left eye, to the left in the right eye, and the right eye itself turns to the left, the left eye to the right. The elements of space-perception are thus unchanged, but the special way in which they are united is entirely different in bidimensional and in tridimensional vision.

As an illustration of theories of the second class, the nativistic theories, we may take Hering's account of visual space-perception. Every retinal point, according to Hering, furnishes, besides its sensations of light and colour, three space-sensations, those of height, breadth and depth. The two former are identical at corresponding retinal points; they give us, taken together, the perception of direction. The sensations of depth are also identical at corresponding points, but are of opposite sign, — positive in the one eye, negative in the other; they are identical and of the same sign at symmetrically situated retinal points; they are, in fact, positive (mean greater distance) on the outer halves of the retinas, and they are negative (mean less distance) on the inner halves. Every binocular perception of an object imaged on corresponding points has, then, the average direction and the average depth-value of all these space-sensations. But the average depth-value is zero; the depth-sensations are of opposite sign; so that all such percep-

tions are localised, by a simple act of sensation, in a plane, Hering's nuclear plane, which has no depth-value at all. Let the point in this plane which corresponds to the two foveas be made the centre of a system of coordinates, such that the height and breadth coordinates lie in the plane itself, and the depth coordinate lies at right angles to it: then we have a geometrical construction which, subject to empirical correction, is adequate to space-perception. Since the observer's body is included in this tridimensional space, the distance of objects from the eye is taken account of in the construction.

What is to be said in criticism? Against Wundt, principally this: that the theory does not explain. To say that space results from the fusion of quality and intensity, however plausibly the statement be made, is to leave us with a mystery; nowhere else, over the whole range of psychology, does the concurrence of attributes (pp. 54 f.) give rise to an absolutely new form of consciousness. And against Hering, this: that the theory is psychologically impossible. Sensations of height and breadth might pass muster, if we mean by them qualitative local signs, but a sensation of depth is an impossibility: depth has no specific quality that can be seen, and, if it had, we have no sense-organ wherewith to see it. Here is, of course, only the barest outline of a criticism; we have no room for details. It may be added, however, that the congenitally blind, to whom sight has been restored by operation, see the world at once as a manifold of two dimensions; neither is surface generated by eye-movement, nor is there any primal perception of depth.

#### References for Further Reading

§§ 85-92. General references are: H. L. F. von Helmholtz, *Handbuch der physiologischen Optik*, 1896, 613 ff.; B. Bourdon, *La perception visuelle de l'espace*, 1902; O. Zoth, *Augenbewegungen und Gesichtswahrnehmungen*, in Nagel's *Handbuch*, iii., 1905, 283 ff.; H. Ebbinghaus, *Grundzüge der Psychologie*, i., 1905, 432 ff.; ii., 1908, 37 ff.; W. Wundt, *Grundzüge der physiologischen Psychologie*, ii., 1910, chs. xiii., xiv.

§ 87. An historical sketch of stereoscopy and pseudoscopy will be found in the author's *Experimental Psychology*, I., ii., 1901, 257 ff.

§ 90. D. Starch, *Perimetry of the Localisation of Sound*, in *University of Iowa Studies in Psychology*, iv., 1905; v., 1908 (Psychological Review Monograph Supplements, 28, 38). On the warning sense of the blind, see a series of articles in the *Zeits. f. experiment. Paedagogik*, iii, 1906 ff.; also L. Truschel, *Das Problem des sogenannten sechsten Sinns der Blinden*, in *Arch. f. d. gesamte Psychol.*, xiv., 1909, 133.

§ 91. W. Wundt, *Die geometrisch-optischen Täuschungen*, 1898; T. Lipps, *Raumaesthetik und geometrisch-optische Täuschungen*, 1897; V. Benussi, *Zur Psychologie des Gestalterfassens*, in A. Meinong, *Untersuchungen zur Gegenstandstheorie und Psychologie*, 1904, 303 ff. A select bibliography of works upon optical illusion is given by the author, *Exper. Psychol.*, I., ii., 1901, 305 ff.; a shorter list by Ebbinghaus, *Psychologie*, ii., 1908, 51 f. For eye-movements, see C. H. Judd and others, in *Yale Psychological Studies*, N. S., i., 1905 (Psychological Review Monograph Supplement, 29); for perspective illusions, J. E. W. Wallin, *Optical Illusions of Reversible Perspective*, 1905.

§ 92. A brief account of Wundt's theory will be found in W. Wundt, *Outlines of Psychology*, tr. 1907, 113 ff.; of Hering's, in E. Hering, *Beiträge zur Physiologie*, Heft 5, 1864, § 124.

## TEMPORAL PERCEPTIONS

§ 93. **The Sensory Attribute of Duration.**— All sensations have the attribute of duration ; all, even the briefest, may be observed as courses in consciousness, as mental processes. And all sensations may be localised in time, as occurring before or after some given sensation. The attribute of duration is, in the author's view, primitive and ultimate, like that of spatial extent ; it corresponds, in consciousness, to the rise, poise and fall of the excitatory nervous process. Localisation in time may also, perhaps, be regarded as analogous to localisation in space. The conscious present (p. 19) varies greatly in objective duration ; but there can be no doubt that it may last for a considerable period of time : it is 'now' during the whole hour that we spend in the dentist's chair, or during the whole morning that we devote to some baffling problem. Within these longer mental presents, at any rate, there will be occasion for the running together of like and the setting apart of diverse qualitative experiences ; and the conscious grouping and separation may not only give the cue to temporal localisation, but may itself be localisation of a crude sort. Duration, the moving extension of a time-field, thus appears as the foundation upon which all forms of temporal consciousness are built up.

Time is usually regarded as a linear extension, a one-dimensional manifold. To the author, it seems that psychological time is rather a surface, a bidimensional manifold, and that its two dimensions are simultaneity and succession. It is true that simul-

taneous sensations go on 'at the same time'; but this same time, in which they go on, is physical time; psychologically, each one of them goes on in its own time. There are thus a number of linear times proceeding side by side; and lines generate a surface. The great difference between bidimensional time and bidimensional space is that the latter is given once for all, and is simply articulated in the course of our experience, while time is made as we live; the time-field is constantly extending.

The existence of a conscious time-field, an extended present, is vouched for by our perception of melody, of rhythm (p. 289), of a polysyllabic word. Under laboratory conditions, this mental present reduces to a period of a couple of seconds: durations themselves are most accurately estimated at about 0.6 sec.; the natural rhythmical unit occupies 1 sec.; accommodation of attention (p. 298) requires 1.5 sec.; the accuracy with which two successive stimuli can be compared increases up to a limit of 2 sec. after the presentation of the second stimulus. Nevertheless, as the following figures will show, even the least of these fields permits of temporal localisation; and it may be added that certain experiments seem to indicate a mental present of 6 sec. duration.

What, then, is the lower limit of temporal localisation? If stimuli follow one another with great rapidity, we have a continuous and uniform sensation; if they come at a lesser rapidity, we have continuity without uniformity,—in vision, shimmer or flicker; in tones, harshness; in noises, rustle or rattle; in touch, roughness. If the rate of succession is still further reduced, we get a true temporal discontinuity, with the distinction of before and after; this appears, in rough average, for sight at an objective interval of  $\frac{1}{10}$  or  $\frac{1}{20}$  sec. (dark and light adaptation), for touch at  $\frac{1}{40}$  sec., and for hearing at, perhaps,  $\frac{1}{100}$  sec. (noise). It is clear, therefore, that a conscious present of no more than 0.6 sec. still gives full scope for localisation.

While, however, these results are important, as showing that the conscious present is always a time-field, and not a time-point, it is to the longer presents of everyday life that we must look for the cues to temporal localisation. The two or three hours of steady attention (p. 293), the whole hour during which a young child

amuses itself with a new toy, the evening devoted to a cram before examination, — periods of this sort, with their diversity of qualitative content and their succession of focal experiences, represent the time-fields within which events are dated.

*Temporal Discrimination.* — A great deal of work has been done upon the comparison of durations. Unfortunately, it was supposed, at the outset, that the simplest time-experience is the interval of 'empty' time between two limiting stimuli. In fact, of course, there is no such thing as an empty mental time; the interval enclosed between two clicks or taps is the duration of something, *e.g.*, of some organic sensation; and the simplest time-experience is the 'filled' time, the duration of a tone or colour or pressure, of some overt and obvious mental content. It has been found, accordingly, that the comparison of intervals is a complicated matter; it is differently grounded for intervals up to about 0.6 sec., for intervals between this and 4 or 5 sec., and for intervals of still longer duration. Short intervals are compared, not as spaces of time between limiting stimuli, but by reference to the stimuli themselves; every stimulus has its own duration, its time-halo; and the comparison is based upon the total temporal impression made by the two pairs of stimuli. Long intervals, again, are compared indirectly, by the help of secondary criteria, and principally by reference to the number of mental processes that run their course within the two stimulus-periods. The middle intervals, from 0.5 to 5 sec., are compared as durations, as spaces of time. Since the differential limen is approximately constant, so that the comparison of the intervals falls under Weber's Law, it is natural to suppose that the internal sensations which here carry the time are qualitatively constant and intensively variable; and introspection points to sensations of strain, whether due to the expectant attitude of the whole body or, more particularly, to the adjustment of the sense-organ to which the limiting stimuli are addressed, as the vehicles of the temporal judgment.

*Temporal Illusions.* — We are subject to gross illusion regarding the rate at which time passes (p. 7). A period that is rich in experiences is short in the living, and long in memory; as it passes,



we have no time to attend to its time-value ; when it has passed, we judge it to have been long by the number of experiences it embraced. There are moments, again, when time appears to stand still ; and there are also, if the author may trust his own observation, occasions when time appears to be running backward : when, *e.g.*, one is retracing, in profound absorption, the steps that have led to a conclusion which one desires to explicate or to justify. These are everyday illusions, due to a great complication of conditions. But illusions are found, also, under the stricter control of the laboratory.

Thus, within certain limits, an interval that is filled by a discontinuous series of sensations appears longer than an empty interval of the same objective length (cf. p. 336, line 2). Or again : when we listen to a rapid series of taps or clicks, we find ourselves forced, as it were, to accent some more strongly than others ; the sounds fall into a rhythm. Suppose that we have three clicks, *i.e.*, two intervals. If we accent the first click, the first interval appears the longer ; if the second, the second ; if the third, the first again : the effect of accent is to lengthen the following and to shorten the preceding interval. If the series of clicks really increases in loudness, the intervals seem to grow shorter ; if it decreases, they grow longer.

*The Index of Change.* — There are two great groups of temporal perceptions, the continuative and the discrete. Typical of the latter is the perception of rhythm, which we discuss in the following Section ; typical of the former is the perception of change, which appears in three distinguishable modes. We may perceive change, first, by the aid of secondary criteria, and especially by kinaesthesia (inhibition of breathing, the swell of inspiration, eye-movement, etc.). We may perceive it, secondly, as a specific pattern of the connection of elementary processes, a temporal overlapping of qualities or intensities within the conscious present. And we may perceive it, thirdly, by what has been termed the index of change : a peculiar modification of quality or intensity such that the attribute under observation shows confusedly, not as a point upon the sensory scale, but rather as something that can be referred only to a region or a section of the scale. The physio-

logical basis of this modification is to be sought in the overlapping of the excitatory processes in sense-organ and nervous system.

§ 94. **The Perception of Rhythm.** — When we walk or run, we have a fairly regular alternation of stronger and weaker sensory complexes. The legs are pendulums, swinging from their point of attachment to the trunk; but the motor functions of the body are ordinarily asymmetrical, — we are right- or left-handed, as we say; and the superior muscular development of the one (usually the right) side means that, in the course of the double pace, the one foot comes down more energetically and swings more quickly than the other. The accent thus introduced into movements of locomotion is reinforced by the sympathetic swing and jerk of the arms.

In the movements of walking, of dancing, of speech and song, we have a tactual basis for the perception of rhythm. It is probable that this basis is primary, though we are now inclined to think of the rhythmical perception rather as auditory than as kinaesthetic; speech and song imply hearing, and even the rhythm of marching and dancing may come to consciousness most emphatically in auditory terms. Sounds are, indeed, the better material for the perception of rhythm: for the limbs, being fixed to the trunk, can give only the most rudimentary, duple rhythms, while sounds, whose stimuli are free, can be divided into groups of any perceivable complexity. Nevertheless, the kinaesthetic component persists. We mark time, beat time, as we listen to music, by free movements of head or foot or hand; and we manage, by spacing or reversing the movements, to imitate in kinaesthesia the complicated rhythms of audition.

It is a moot point whether the perception of rhythm may appear in complete independence of kinaesthesia. In the case of speech and song we have, of course, not only the muscular adjustments of

the larynx, but also the rhythmical play of the respiratory muscles. The author was formerly disposed to attribute a separate rhythmical perception to hearing, but recent observation has convinced him of the existence of kinaesthetic sensations due to the contraction of the *tensor tympani* of the middle ear. It is true that change of pitch may determine the character of an auditory rhythm. But pitch may here be regarded as a substitute for, or as itself the equivalent of, intensity: the former, if it arouses associations which, referred to their ultimate ground, are of an intensive character; the latter, if strain sensations are evoked both by intensity and by quality of the sound stimulus.

Auditory rhythm may, in fact, be obtained by subjective accentuation (pp. 289 f., 343), and by variation of the duration, temporal separation, intensity, and pitch of the stimuli employed. Subjective accent is a matter of the insistence (p. 55) of certain elements in the stimulus complex; it is favoured by the observer's general attitude, and is oftentimes supported by large organic fluctuations (respiration, swing of the whole trunk). The primitive form or material of rhythm — for the level from which the perception of rhythm may be dated is still in dispute — is a discrete series of equally intensive impressions, whose members are separated by equal pauses: one finds it, *e.g.*, in the syllabic reading of young children. Out of this grows, first the duple rhythm, probably in the order spondee, trochee, iambus, though the priority of the trochee is disputed; and then the triple rhythm, probably in the order dactyl, anapaest, amphibrach. The limits of rhythmical complexity have been discussed above, pp. 289 f.

The perception of rhythm may be aroused by visual impressions, whether by simple series of discrete stimuli, presented under laboratory conditions, or by the sight of rafters on a corridor ceiling, or of the recurring ornaments on a façade. In the author's opinion, this rhythm is always kinaesthetic, based upon eye-movement, upon slight movements which tick off the successive impressions, or upon some other form of intermittent kinaesthesia. Even those writers who believe in a purely visual rhythm acknowledge that kinaesthetic associates are almost invariably present, and are exceedingly difficult to suppress.

§ 95. **Theories of Time-Perception.**— In principle, we have in the case of time the same divergence of psychological theory that we noted in that of space. There are psychologists who derive, or generate, time from the intimate connection of processes that are themselves considered to be timeless. There are also psychologists who make the two great temporal characters, duration and order, ultimate and irreducible. We have ourselves followed the lines laid down for a theory of space-perception; we have assumed that duration is an attribute of all sensations, and have regarded temporal localisation as a corollary of duration.

As illustrative of the genetic theories, we may take Wundt's account of the origin of temporal ideas. "A sensation thought of by itself," Wundt declares, "can no more have temporal than it could have spatial attributes." The fundamental datum, in time as in space, is order, arrangement; duration, like extent, is for Wundt a secondary formation. Sensations are ordered in time by the help of temporal signs, just as they are ordered in space by the help of local signs. The temporal signs are fusions of affective with sensory elements: the affective qualities of tension and relaxation (p. 250) blend with the intensively graded series of kinaesthetic (especially strain) sensations. The time-perception is thus "a fusion of the two kinds of temporal signs [the intensive and the qualitative] with each other and with the objective sensations arranged in the temporal form." The fixation-point of time, the 'now' of consciousness, is determined primarily by affective processes; since these change, the fixation-point is constantly changing; and this change of fixation-point is what we mean when we speak of the flow of time.

As illustrative of the nativistic theories, we may take Ebbinghaus' account of temporal perceptions. Sensations, according to Ebbinghaus, have two classes of attributes: the individual or specific, and the general or common. In the latter class he includes space

and time (extent and duration), movement and change, likeness and difference, unity and multiplicity. Rhythm falls under the heading of unity and multiplicity. Temporal order, succession, is merely discreteness of duration, the alternation of 'duration' and 'interval'; and the distinction of duration and interval is itself merely a matter of direction of attention; we call the temporal attribute 'duration' when we are attending to some attribute of the durable process, and 'interval' when we are indifferent to this process, but attentive to its limiting impressions.

Wundt's theory is open to the objection urged against his theory of space. The blending of affective process with sensation means, elsewhere in the mental life, not time but feeling; and we cannot understand how, in this particular case, the new product should arise. Ebbinghaus' category of general or common sense-attributes seems to the author to take too much for granted; we are bound to push our analysis as far as it will go. Ebbinghaus appears, as regards both temporal localisation and the perception of rhythm, to halt before he has reached the psychological goal.

All theories of time recognise the importance of secondary criteria, whether of duration or of localisation. Length of time may be estimated by number and variety of experiences, by our boredom, by the strain of expectation, by reference to a familiar time-standard; the date of an experience may be settled by range and particularity of memory, by reference to some salient event, by verbal association, and so on. These things have, however, nothing to do with the specific perception of time.

#### References for Further Reading

§§ 93-95. Wundt, *Physiol. Psychologie*, iii., 1903, 1 ff.; Ebbinghaus, *Psychologie*, i., 1905, 432 ff., 480 ff., 504 ff. A brief account of Wundt's theory will be found in his *Outlines*, tr. 1907, 170 ff.

A bibliography of the work done upon temporal discrimination is given in the author's *Experimental Psychology*, II., ii., 1905, 393 ff. For the perception of rhythm, see *ibid.*, I., ii., 1901, 337 ff.; R. MacDougall, *The Structure of Simple Rhythm Forms*, in *Harvard Psychological Studies*, i., 1903, 309 ff. (Psychological Review Monograph

Supplement, 17); C. R. Squire, *A Genetic Study of Rhythm*, in *American Journal of Psychology*, xii., 1901, 492 ff.; K. Koffka, *Experimental-Untersuchungen zur Lehre vom Rhythmus*, in *Zeits. f. Psychol.*, lii., 1909, 1 ff. For the mental present, see L. W. Stern, *Psychische Präsenzzeit*, *ibid.*, xiii., 1897, 325 ff.; for the perception of change, the same author's *Psychologie der Veränderungsauffassung*, 1898.

## QUALITATIVE PERCEPTIONS

§ 96. **Qualitative Perceptions.** — We have had instances of qualitative perception in the musical or compound tone (§ 25), in the various taste-blends (§ 34), in the touch-blends (§ 50), and in certain organic complexes, such as nausea and hunger (p. 188). It is characteristic of all these experiences, first, that the component qualities blend, fuse, run together, so that the perception appears simple, or at least unitary; but, secondly, that the components can still be identified, so that the perception may be analysed, under rigorous scrutiny, into a number of elementary processes. It follows from the sensory blending that the qualitative perception may become focal in consciousness as a whole. A recent writer has declared that the 'texture' of qualitative perception, due to the 'massing' of its sensory elements, — it is difficult to find words to indicate precisely what is meant, — may, in certain spheres, be as important in creating apparent qualitative differences as is the quality of the single sensation;<sup>1</sup> and James, in a well-known passage, has argued that the taste of lemonade comes to us, at first, as a simple quality.<sup>2</sup> This fact, then, is important: that we may attend to the perception as a whole, and that the blending may be so complete as to give us the illusion of qualitative simplicity. But the other fact, that systematic observation always reveals the complexity of the perception, is of no less importance. We may attend separately to the separate components; and, if we take

<sup>1</sup> E. Murray, *Organic Sensation*, in *American Journal of Psychology*, xx., 1909, 446.

<sup>2</sup> W. James, *Principles of Psychology*, ii., 1890, 2.



this attitude, the perception breaks up into a number of really simple, sensory qualities. Thus, an observer who has never tasted limes will, if he is versed in introspection, distinguish the cold, the peculiar aroma, and the sweet, sour and bitter of limade, while his non-psychological host, who has put the ingredients together, will regard the 'taste' as a simple and single experience. The writer just quoted remarks, in another connection, that "many of the differences regarded at first sight as ultimate resolve themselves, on analysis, into differences in the consolidation and coordination of the component sensations," and adds that "the dissection here carried out is not purely hypothetical, but was effected in almost every case directly by introspection."<sup>1</sup>

James warns us here against two erroneous inferences. The one is "that because we gradually learn to analyse so many qualities we ought to conclude that there are no really indecomposable feelings<sup>2</sup> in the mind." We have spoken of this matter above, pp. 50 f. The other is "that because the processes that produce our sensations are multiple, the sensations regarded as subjective facts must also be compound." We referred to this source of error, the stimulus-error, on p. 218. In some cases, the stimulus-error is ruled out by the observer's ignorance of the conditions under which the mental process laid before him for analysis is produced; in general, however, it can be overcome only by long training. A third inference, which is certainly as dangerous as the two mentioned, is this: that the psychological elements, just because they are elementary, are chronologically the first things in mind, so that perceptions grow, are formed, by the interconnection of originally separate sensations. The elements are, as we have seen (pp. 37 f.), the results of analysis; the perceptions are the original

<sup>1</sup> E. Murray, *A Qualitative Analysis of Tickling: its Relation to Cutaneous and Organic Sensation*, in *American Journal of Psychology*, xix., 1908, 315 ff.

<sup>2</sup> 'Feelings' here mean 'mental processes'; 'sensations,' in the next quoted sentence, mean any cognitive processes that give us bare acquaintance with a fact.

things, and the sensations are found in them by observation; perceptions are given us, and we discover that they are analysable. Misunderstanding here is fatal to the student of psychology, for it means misapprehension of the central psychological problem.

§ 97. **Tonal Fusions.**—The classical instance of the qualitative perception is the tonal fusion. We saw in § 25 that the musical tone is a complex of fundamental and overtones, and that its wave-train may be analysed into simple waves whose vibration-ratios are 1 : 2, 3, 4, etc. In other words, the musical tone is a tonal fusion. It is, however, a fusion of a complicated kind; for the overtones vary in intensity, and are present (p. 102) in some numbers.

We get tonal fusion at its purest by sounding together two simple tones at the same intensity. Under these conditions, we find that there are degrees of fusion. The following Table shows the observed facts.

DEGREE OF FUSION	ILLUSTRATIVE TONES	VIBRATION-RATIO OF STIMULI
(1) Octave . . . . .	<i>c, c</i> <sup>1</sup>	1 : 2
(2) Fifth . . . . .	<i>c, g</i>	2 : 3
(3) Fourth . . . . .	<i>c, f</i>	3 : 4
(4) Major third . . . . .	<i>c, e</i>	4 : 5
Minor third . . . . .	<i>c, e</i> ♯	5 : 6
Major sixth . . . . .	<i>c, a</i>	3 : 5
Minor sixth . . . . .	<i>c, a</i> ♭	5 : 8
(5) Subminor fifth . . . . .	<i>c, g</i> ♭ —	5 : 7
Subminor seventh . . . . .	<i>c, b</i> ♭ —	4 : 7
(6) Major second . . . . .	<i>c, d</i>	8 : 9
Minor second . . . . .	<i>c, d</i> ♯	15 : 16
Major seventh . . . . .	<i>c, b</i>	8 : 15
Minor seventh . . . . .	<i>c, b</i> ♯	9 : 16

These results, obtained both with simple and with musical tones, have been confirmed both by the individual judg-

ments of trained observers and by the collective observations of untrained persons. They mean that the tones of the octave, when all secondary criteria have been ruled out, are heard as a blend, whose unitariness is nearly akin to the simplicity of a tonal sensation, while the tones, *e.g.*, of the major seventh fall apart as they are heard. Recognition of the component tones makes no difference to the degree of fusion; we may know that an octave is sounding, and may be able to identify the tones that compose it; but so long as we are listening to the octave, so long as the fusion itself is focal, we still hear the unitary tone-blend.

The phenomena of tonal fusion have been studied in great detail, — with assemblages of more than two tones, with varying intensities of the components, with distribution of the stimuli to the two ears, in intervals beyond the octave, in mistuned musical intervals. For our purposes, however, it is unnecessary to go further. The essential thing is to grasp the twofold character of the fusion: its relative unitariness, and its recognisable complexity. The unitariness is given, sensibly, as we hear it; analysis leaves it as unitary as it was before. Yet the unitariness is never that of a chemical transformation; analysis, for the normal ear and after practice, is always possible.

§ 98. **Theories of Qualitative Perception.** — When we are looking for the physiological conditions of extent and duration, our problem is to discover some property of the sense-organs that can bring them into correspondence with the spatial and temporal aspects of stimuli. Physical objects lie in physical space; physical events occur in physical time. Hence the explanation of extent and duration is of the same general kind as the explanation of quality and intensity; the various aspects of the stimulus must be correlated with certain modes of sensory excitation. Our present problem is of a different kind. We

have to discover the physiological conditions both of the unitariness of the qualitative perception and of the possibility of its analysis. We begin with tonal fusion.

Stumpf, to whom we are chiefly indebted for our knowledge of the facts of tonal fusion, thinks that analysis is conditioned by peripheral, fusion by central factors; the ear analyses, if we may so phrase it, and the brain blends. He ascribes the blending to a specific synergy of the nerve-centres, to a determinate mode of cooperation between the nervous structures affected by the tonal excitations. In the present state of brain physiology, this theory, as Stumpf admits, is little better than a form of words; it simply warns us that we shall fail to find in the ear a mechanism for the appearance of fusion. Ebbinghaus, on the other hand, believes that fusion can be explained in terms of the peripheral mechanism; the Helmholtz theory is adequate both to analysis and to blending.

We know that, according to the Helmholtz theory (§ 26), the ear is an analyser: let us see how the theory accounts for fusion. We may begin with the simplest case, that of the octave. Suppose that two tones, whose pitch-numbers are 300 and 600 respectively, are sounding together. They will set into vibration the basilar fibres whose normal vibration-rates are 300 and 600 in the 1 sec. But they will also, Ebbinghaus says, set in vibration the harmonic undertone fibres; nodes will be formed, and the fractional parts of the undertone fibres will take on the rhythm of the primaries. Thus,

the 300-stimulus causes the following fibres to vibrate at the rates shown:

300 × 1  
150 × 2  
100 × 3  
75 × 4

the 600-stimulus causes the following fibres to vibrate at the rates shown:

600 × 1  
300 × 2  
200 × 3  
150 × 4

and so on. It is clear that the 300-fibre is asked to vibrate both as a whole ( $\times 1$ ) and in halves ( $\times 2$ ), the 150-fibre both in halves and in quarters. The fibre takes up the easier, that is, the slower vibration, and ignores the other, so that the higher tone, that of 600, loses some of its body; the lower tone steals from it. Consequently, the upper tone becomes a mere shadowy parasite of the lower tone, and we have the fusion of the octave. It is matter of observation that in duple fusions the lower tone carries or dominates the fusion.

Now consider the tones 300 and 480, a minor sixth. The fibres stimulated will be

300 $\times$ 1	480 $\times$ 1
150 $\times$ 2	240 $\times$ 2
100 $\times$ 3	160 $\times$ 3
75 $\times$ 4	120 $\times$ 4
60 $\times$ 5	96 $\times$ 5

and so on. Here there is no identity of fibres in the two columns; but 150 stands near to 160, and 100 to 120. Since the basilar membrane vibrates, not in single fibres, but in narrow strips (p. 111), the 160- and 120-fibres will be hampered in their vibration. The lower tone again steals from the upper, though less cleanly and to a less extent than in the instance of the octave.

It should be added that Ebbinghaus does not deny the possibility of a central factor in fusion; he is concerned only to show that the peripheral mechanism affords a plausible explanation. There is, however, one point of observation upon which he and Stumpf are sharply at variance. Stumpf declares that fusion remains the same, whether the tones are heard under the ordinary conditions of binaural hearing, or are heard separately by the two ears, or are represented in imagination; and it would be curious, he says, if in the first of these cases the fusion should be a peripheral, and in the others a central matter. Ebbinghaus maintains that, if very weak and fairly low tones, say, of 400 and 600 vs., are heard binaurally, the higher tone is practically lost in the lower; whereas, if the tones are carried separately to the two ears, they are heard "with perfect clearness and distinctness side by side."

Whether Ebbinghaus has made his point is a question that will be answered differently by different psychologists; he has at all events given a theory that is definite in outline and that appeals to known physical principles. Yet it seems that qualitative perception in general must be referred to central, and not to peripheral conditions. Where the fusion occurs between qualities of separate senses, as in the taste-blends, this conclusion cannot be escaped. But even in the case of the touch-blends there is evidence that the blending depends, not upon peripheral irradiation, but upon processes within the nervous system. What these processes are, and how it is possible that now the total perception and now its sensory constituents may become focal in consciousness, we do not know.

#### References for Further Reading

§§ 96-98. C. Stumpf, *Tonpsychologie*, ii., 1890, 127 ff., 184 ff.; H. Ebbinghaus, *Psychologie*, i., 1905, 318 f., 344 ff. Wundt gives a psychological theory of fusion in the *Physiol. Psychol.*, ii., 1910, 116 ff., 430 ff.

## COMPOSITE PERCEPTIONS

§ 99. **Simple and Composite Perceptions.**—The perceptions that we have so far discussed may be termed simple perceptions, since they rest upon a single sensory basis, upon the sense-attribute of extent or duration, or upon the concurrence of sensory qualities. There are also various types of composite perception. Thus, the perception of a movement in the field of vision or of touch is both temporal and spatial; the movement has duration, and it has at the same time extension (spatial magnitude) and direction. The perception of melody is both qualitative and temporal. The perception of a thing, an object, is qualitative and spatial; the perception of a scene, a situation, an event, is qualitative, spatial and temporal.

It is not necessary to take up all these composite perceptions in detail; for the most part, their analysis follows at once from that of the simple perceptions. We must, however, say something of the perceptions of movement and of melody.

§ 100. **The Perception of Movement.**—We need not discuss how a moving object is localised, or how we perceive the magnitude, direction and duration of the movement; these questions have already been answered. The difficult thing about movement is its continuity; and the difficulty is resolved in the alternative ways, by nativistic and genetic theories. Some psychologists regard the specific experience of movement as ultimate and irreducible; they even speak of sensations of movement, not in the familiar



sense of the sensations aroused by movement of the body or limbs, but in the literal sense; they believe that the moving stimulus arouses a sensation of moving, what we might call a travel-sensation. Other psychologists find the sensory basis of continuity in the positive after-image (p. 68), the persistence of sensation after the cessation of stimulus. By help of this after-image, they say, we are able, within the mental present, to see or feel a stimulus as extended over the whole space between the point which it has just left and the point to which it has just come; the tailing-off of the after-image, its gradual loss of intensity, forbids us to perceive this extension as a spatial extent pure and simple; and the recognition of the moving object as less extended than its path, and as identical at all points of its course, clinches the perception of movement. The author inclines to accept the genetic view, though there are certain observations which it has, so far, failed to explain.

A good deal of work has been done upon the quantitative aspects of the perception of movement,—the minimal and maximal rates at which movement may be perceived, the differential limen of rate, and so on. We notice only two points. The first, which indicates the insistent character of the moving stimulus (p. 269), has to do with the extensive limen of movement. In direct vision a moving stimulus, to be perceived as moving, must traverse a distance sensibly equal to that which permits of the local distinction of two stationary points: the limen of spatial duality and the extensive limen of movement are practically identical. But in indirect vision, and in the cutaneous space-field, the stimulus is perceived as moving when it has traversed only about a quarter of the distance required for the perception of duality. It is clear that, as we said above (p. 271), movement makes a very special appeal to the organism. The second point is that the

discrimination of rates of visual movement is, within certain limits, subject to Weber's Law ; it seems, then, that kinaesthetic sensations play the same part here that they play in the discrimination of the moderate time-intervals (§ 93).

On the side of extent, the perception of movement is simply a mode of the perception of spatial magnitude. It may be worth while to remark — though the fact is implied in previous discussions — that estimation in terms of eye-movement is very uncertain, unless there is somewhere in the field of vision a fixed point of reference. Movements of the eyes, to and fro, are continually going on, and are rarely remarked.

*Illusions of Movement.*—We can, again, notice only a few typical illusions. If a stimulus moves over the skin at uniform rate, we take the movement to be quicker where localisation is more accurate, slower where it is less accurate (cf. p. 326). Illusions of visual movement are very frequent, and are due to a great variety of conditions. It is a general rule, *e.g.*, that a fixated object is seen at rest. Hence, if we fixate a tree from the window of a moving train, the tree itself appears to stand still, while the objects on this side of it move backwards, and those beyond it move with the train forwards. Yet the moon, seen between moving clouds, seems to move, and the clouds seem to stand still ! Some other principle is evidently at work : possibly the principle that small objects are more likely to move than large.

*The Synthesis of Movement.*—The perception of movement may be synthesised by means of the stroboscope, in which discrete phases of some objective movement are thrown in rapid succession upon the retina : the instrument is familiar as a toy, and is popularly known as the zootrope. The stroboscopic effect has usually been referred to the persistence of sensation in the positive after-image. But the cylinder may be turned so slowly that the bridging of the gaps by after-images is out of the question, and the perception of movement still continues. It follows that conscious predisposition (cortical set) is of great importance for the perception of movement, — a fact which seriously complicates the problem set us by certain movement-illusions.

In the stroboscope, our vision of the pictures is periodically

interrupted by the solid parts of the cylinder-wall, between the slits; if it were not for this interruption, the pictures and their background would run together into a meaningless blur. For the same reason, the photographic ribbon of the kinematograph, or moving-picture machine, is passed before the lens of the projection lantern not continuously, but by jerks; every picture is allowed to remain stationary for a moment before

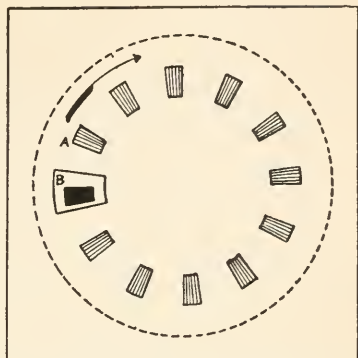

FIG. 58. B. Bourdon, *La perception visuelle de l'espace*, 1902, 194.

it is displaced by the next succeeding picture.

*The Effect of Conscious Predisposition.* — If two like objects appear in succession, at different points in space, under conditions which do not preclude the idea of movement, we almost inevitably perceive the movement of a single object. Figure 58 represents a white disc, upon which a series of similar figures *A*, *B* have been painted in black; before the disc stands a screen with a small window for observation. Let the disc rotate, in the direction of the arrow, at such a speed that an interval of some quarter-second elapses between the appearances of two neighbouring figures. As the figure is drawn, *A* has already passed the window, and *B* is coming into view. But *B* does not

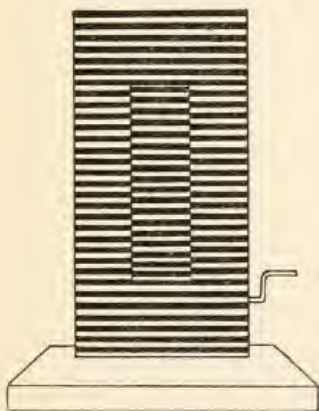

FIG. 59. James' Artificial Waterfall. — W. James, *Mind*, O. S. xii., 1887, 517; *Principles of Psychology*, ii., 1890, 245.

Very striking after-images may be obtained by the slow rotation, on the colour-mixer, of a white disc upon which has been painted in black an Archimedean spiral. — E. Mach, *Grundlinien d. Lehre von d. Bewegungsempfindungen*, 1875, 59.

rise from below ; at the moment indicated, the observer has the distinct perception of an abrupt descent of *A*. The succession *A-B* is perceived as the movement of a single *A*.

*After-images of Movement.* — If we look for a while at the water over the side of a moving vessel, or gaze at a waterfall, or keep our eyes upon the moving roll in a piano-player, and then turn to the planks of the deck, or the banks of the stream, or the name-plate on the cover of the instrument, we get the perception of a reversed movement, a sort of negative after-image of the original. This after-effect cannot be referred to involuntary movements of the eyes, since it appears only at that part of the field which was occupied by the stimulus. The most plausible explanation, on a genetic theory, is this. The moving object leaves in the eyes a mass of shifting and fading after-images, which, if seen for themselves, would simply continue the perception of movement in the original direction. Their qualitative character is, however, merged and lost in the qualities of the field upon which they are projected. Since, nevertheless, they still suffice to give a cue to the perception of movement, their passage over the field must arouse the illusion that this is itself in motion, and in the opposite direction. The explanation is not altogether satisfactory, and it must be confessed that, in this matter, a nativistic theory of the perception of movement has the advantage.

§ 101. **The Perception of Melody.** — As movement is both temporal and spatial, so melody is both temporal and qualitative. It presupposes rhythm; and it presupposes the formation of a musical scale, and the classification of the intervals of this scale as consonant and dissonant.

Rhythm we have already discussed. The conditions that led to the discovery and the selection of melodic intervals are still obscure; Stumpf refers melody to the fact of fusion, while Wundt distinguishes a number of factors, chief among which is what he terms the direct relationship of the compound tones.

According to Stumpf, consonance depends on fusion, and degree of consonance upon degree of fusion. And fusion is operative in the case of successive, as it is in that of simultaneous, tones; the second tone fuses with the image (§ 61) of the first, or, if both tones have ceased, the image of the one fuses with the image of the other. Homophonic and polyphonic music, melody and harmony, thus have their common root in tonal fusion.

Here, however, an objection arises. Was not primitive music homophonic? And could the hearing of successive tones bring the differences of fusion-degree so clearly to consciousness that a musical scale should result? Stumpf replies that primitive music was not wholly homophonic. Men and women, or men and boys, chanted together, and the difference of register would give the intervals, at any rate, of the octave and the fifth; untrained singers, who think that they are singing in unison, will sing, according to the compass of their voices, in unison, in octaves, or in fifths. Moreover, musical instruments are a very early invention; and the fusion-degree of the fourth, the thirds, etc., occurring by chance, might strike the fancy of the primitive musician, and so the intervals might be fixed and employed. Finally, the addition of a drone-bass, vocal or instrumental, would help to keep the singer within certain tonal limits. — It may be added that, while we are accustomed to think of a scale as beginning in the bass and continuing upwards to the treble, primitive scales, at least in very many instances, run from treble to bass. The earliest melody was probably somewhat like our recitative; and the voice naturally falls at the end of a sentence. Now the descending fourth is the ordinary drop of the voice in speaking, as the ascending fifth is its ordinary rise in questioning. It seems, then, that the interval of the fourth may have been fixed, in primitive music, as early as the octave and the fifth, but fixed in the descending direction.

According to Wundt, consonance derives from four principal sources, two of which are metric and two phonic. In the first place, the most consonant tones are those which, given together, arouse the fewest difference-tones, — the tones of the octave and the fifth. These intervals, fixed by group-singing, set the limits within which the single voice or instrument is to move. Secondly, the ear is

able, within certain limits, to compare and to equate tonal distances (cf. p. 209) ; and, as the absolute sensible discrimination is here constant, the octave is thus bisected into fifth and fourth, the fifth itself into major and minor thirds. Thirdly, to pass to the phonic principles, we find that consonance depends upon the direct and indirect relationship of the compound tones ; that is to say, upon the number and intensity of their common overtones, and upon the nearness of their relation to a common fundamental. Fourthly, consonances are characterised by a peculiar mode of fusion : the fusion is less intimate than, *e.g.*, in the prime, or the continuative noise (p. 97) ; it is a 'distinct' fusion, a fusion of discriminable elements, as contrasted with the 'diffuse' fusion of the noise ; and it is a fusion whose dominating tone owes this dominance, not to any characteristic of its own, but to the concurrence of the three conditions of consonance which we have already mentioned.

These four factors in the perception of consonance combine, under different circumstances, in different ways. The succession of pure tones in a melody depends upon the metric principles and upon indirect relationship ; the succession of compound tones depends almost entirely upon the phonic principles, and especially upon direct relationship.<sup>1</sup> Both in harmony and in melody, consonance is, for Wundt, primary, and tonal fusion only secondary.

A choice between the rival theories is, at the best, very difficult. The questions involved are, for the most part, beyond the reach of experiment, while our knowledge of primitive music, as it exists in the world to-day, is imperfect, and the results so far obtained have not been systematised. Where experiments are possible, their outcome is often rendered uncertain by the musical training of the observers ; aesthetics may cut across psychology. We shall therefore do well to suspend judgment.

It is natural that, as the scale becomes complex, the rules of melody become precise ; but these rules, as well as the affective aspects of rhythm and interval, lie beyond our present horizon. The unit of our modern scale is, of course, the semitone ; and it is

<sup>1</sup> Stumpf does not deny the influence of direct relationship upon the primitive perception of melody, but he confines it to the intervals of octave and fifth.



worth noting that this, while it is by no means the least difference of pitch that the ear can distinguish (p. 98), is the least difference that can be accurately sung. The larynx is the earliest musical instrument, and the singing of grace-notes, with a just noticeable difference of laryngeal adjustment, may be responsible for the final form of the musical scale.

### References for Further Reading

§ 100. B. Bourdon, *La perception visuelle de l'espace*, 1902, 176 ff.; H. Ebbinghaus, *Psychologie*, i., 1905, 489 ff.; W. Wundt, *Physiol. Psychol.*, ii., 1910, 611 ff.

§ 101. C. H. H. Parry, *The Evolution of the Art of Music*, 1896; H. L. F. von Helmholtz, *On the Sensations of Tone*, 1895, 234 ff.; C. Stumpf, *Konsonanz und Dissonanz*, in *Beiträge zur Akustik und Musikwissenschaft*, i., 1898, 1 ff.; W. Wundt, *Physiol. Psychol.*, ii., 1910, 440 ff.; iii., 1903, 138. A 'motor' theory of melody is outlined by W. V. D. Bingham, *Studies in Melody*, 1910 (Psychological Review Monograph Supplement, 50); here may also be found references to the work of the most recent investigators of the subject.



## THE PSYCHOLOGY OF PERCEPTION

§ 102. **Pure and Mixed Perceptions.**— Let us assume for the moment that any perception may be analysed, without remainder, into a number of sensations. It would still be true that the mere enumeration of these sensations is not an adequate account of the perception. For the sensations which we find, in the particular case, form a group; they have been selected, singled out, marked off, from the other contents of consciousness. Their fewness is due to the limited range of attention (§ 80), and their present appearance as a group at the conscious focus depends upon conditions which we have already discussed (p. 270). The grouping itself, the special mode of connection of the sensations, we have tried to explain in the preceding Sections.

The simplest kind of perception, then,— what we may call the pure perception,— implies the grouping of sensations under the laws of attention. But it is clear that perceptions are, as a rule, not made up solely of sensations; we see and hear and feel more than is presented to eye and ear and skin; the given sensations are supplemented by images. Most of our perceptions are mixed perceptions, complexes of sensory and imaginal elements; and the life of perception is, far more than one is apt to suppose, a life of imagination.

We may have at any rate an approximation to the pure perception (cf. pp. 50 f.) both in the laboratory and in everyday life. When, *e.g.*, we are comparing two linear extensions by eye, or when we are listening to a tonal fusion, with secondary criteria so

far as possible ruled out, consciousness is practically restricted to the sensation-group. So, if we are unpacking the parts of a new and complicated instrument, and come upon something the use of which is not immediately apparent, the few seconds of intent scrutiny are taken up with a pure perception. The author was once shown a photograph, which consisted of a circular field scrawled all over with random and zigzag marks, and was asked what it was. Here was a pure perception; there was no supplementing by images. Then the suggestion came: Look at the back! On the back was a date, and the date was that of a great earthquake. The perception at once became mixed; the photograph was a seismogram.

Ordinarily, however, our perceptions come to us as mixed. To realise how inevitably they are mixed, devote a couple of days to the following observation: whenever any casual object strikes your attention, do not be content to pass it by with a hasty identification, but go up to it and examine it. You will find that the bit of glass in the grass is really a bit of grey limestone upon which the sun is shining; that the twig which caught your eye because it seemed to move did move—and is a caterpillar; that the enamelled bowl in which a careless servant has left the water is dry and empty. You will, in a word, be amazed to find how little you 'perceive' and how much you 'imagine.' We have touched on this point above (p. 199), and have suggested that the general reliability of perception may be due, in part, to the different setting in consciousness of sensation and image, in part to an intrinsic difference in the conscious stuff of which the two processes are made. We may now add that, where the image is incorporated in the perception, it obeys the same laws as sensation, and that this likeness of behaviour, while in certain cases it favours illusion, must also on the whole favour an adequate apprehension of stimuli. It is hardly too much to say that the occurrence of illusions is a guarantee of general reliability: glass in the grass does look like that, things that grow on shrubs are twigs, water left in the bowl would give this appearance. We return to the matter in § 118.

The images that supplement the pure perception are different in

different minds. In general, they seem to be of three principal sorts: visual, auditory-kinaesthetic (verbal), and kinaesthetic. In minds of a certain type, all tactual perceptions are visually supplemented: a touch upon the skin calls up a mental picture of the part stimulated (§ 88), or—as when we bump against something in the dark—a visual picture of the stimulating object. Silent reading, again, is almost invariably accompanied by internal speech; very few persons, and these only after special practice, can read by eye alone, without arousing a train of auditory-kinaesthetic word-ideas: General kinaesthetic supplements, derived from our experiences of handling objects, are also exceedingly common: things look heavy or light, sound heavy or light, precisely as they look or sound here or there, near or far (§ 91).

*The Doctrine of Apperception.*—The two points to which we have called attention in this Section, the selective grouping of the sensory constituents of perception, and the supplementing of the sense-group by images, are the cardinal points of the doctrine of apperception in the systems of Wundt and Herbart.<sup>1</sup> According to Wundt, “the state which accompanies the clear grasp of any psychical content, and is characterised by a special feeling [the feeling of activity, a compound of tension and excitement (§ 72)], we call attention. The process through which any content is brought to clear comprehension we call apperception.”<sup>2</sup> According to Herbart, “as soon as any considerable number of ideas, connected in various ways, is present to the mind, every new perception must act as a stimulus, by which some of the existing ideas are checked, others heightened and reinforced, and some trains of ideas are disturbed, others set in motion. But the new perception itself, as soon as its initial stimulation has worked, is assimilated, in a passive way, to the older ideas, since these, in virtue of their interconnections, are much stronger than the single intruder”:<sup>3</sup> the incoming percep-

<sup>1</sup> See especially Ebbinghaus, *Grundzüge der Psychologie*, ii., 1908, 29 ff.

<sup>2</sup> W. Wundt, *Outlines of Psychology*, tr. 1907, 233. The student should read the whole of § 15, on Consciousness and Attention. The chapter is by no means easy, but should be intelligible in the light of our own discussion.

<sup>3</sup> J. F. Herbart, *Lehrbuch zur Psychologie* [1816, 1834, reprinted in the *Sämmtliche Werke*], § 39. The translation has been somewhat condensed.—

tion is apperceived by the preexisting ideas, the apperceiving masses. The doctrine of apperception, in some form more or less closely resembling that of Wundt or Herbart, figures in many psychologies. It is a question, however, whether there is any real gain in the introduction of the term.

§ 103. **Meaning.** — Perceptions are selected groups of sensations, in which images are incorporated as an integral part of the whole process. But that is not all: the essential thing about them has still to be named: and it is this, — that perceptions have meaning. No sensation means; a sensation simply goes on in various attributive ways, intensively, clearly, spatially, and so forth. All perceptions mean; they go on, also, in various attributive ways; but they go on meaningly. What then, psychologically, is meaning?

Meaning, psychologically, is always context; one mental process is the meaning of another mental process if it is that other's context. And context, in this sense, is simply the mental process which accrues to the given process through the situation in which the organism finds itself. Originally, the situation is physical, external; and, originally, meaning is kinaesthesia; the organism faces the situation by some bodily attitude, and the characteristic sensations which the attitude arouses give meaning to the process which stands at the conscious focus, are psychologically the meaning of that process. For ourselves, the situation may be either external or internal, either physical or mental, either a group of adequate stimuli or a constellation of ideas; image has now supervened upon sensation, and meaning can be carried in imaginal terms. For us,

A popular account of the Herbartian psychology is given by J. Adams, *The Herbartian Psychology applied to Education*, 1898, ch. iii.

*better handling  
revision.*

therefore, meaning may be mainly a matter of sensations of the special senses, or of images, or of kinaesthetic or other organic sensations, as the nature of the situation demands.

Of all its possible forms, however, two appear to be of especial importance: kinaesthesia and verbal images. We are locomotor organisms, and change of bodily attitude is of constant occurrence in our experience; so that typical kinaesthetic patterns become, so to say, ingrained in our consciousness. And words themselves, let us remember, were at first bodily attitudes, gestures, kinaesthetic contexts: complicated, of course, by sound, but still essentially akin to the gross bodily attitudes of which we have been speaking. The fact that words are thus originally contextual, and the fact that they nevertheless as sound, and later as sight, possess and acquire a content-character, — these facts render language preeminently available as the vehicle of meaning. The words that we read are both perception and context of perception; the auditory-kinaesthetic idea is the meaning of the visual symbols. And it is obvious that all sorts of sensory and imaginal complexes receive their meaning from some mode of verbal representation: we understand a thing, place a thing, as soon as we have named it.

Hence, in minds of a certain constitution, it may well be that all conscious meaning is carried by total kinaesthetic attitude or by words. As a matter of fact, however, mental constitution is widely varied, and meaning is carried by all sorts of sensory and imaginal processes.

The gist of this account is that it takes at least two sensations to make a meaning. If an animal has a sensation of light, and nothing more, there is no meaning in consciousness. If the sensation of light is accompanied by a strain, it becomes forthwith a

perception of light, with meaning ; it is now 'that bright something' ; and it owes the 'that something' to its strain-context. Simple enough !—only be clear that the account is not genetic, but analytic. We have no reason to believe that mind began with meaningless sensations, and progressed to meaningful perceptions. On the contrary, we must suppose that mind was meaningful from the very outset. We find, by our analysis (§ 96), that sensation does not mean ; and we find, in synthesis, that the context which accrues from the situation, however simple or however complex the context may be, makes it mean, is its meaning.

What, then, precisely, is a situation ? The physical or external situation is the whole external world as an organism, at any given moment, takes it ; it consists of those stimuli to which the organism, by virtue of its inherited organisation and its present disposition, is responsive, — which it selects, unifies, focalises, supplements, and, if need be, acts upon. The mental or internal situation is, in like manner, some imaginative or memorial complex which is fitted, under the conditions obtaining in the nervous system, to dominate consciousness, to maintain itself in the focus of attention, to serve as the starting-point for further ideas or for action. To put the definition in a word, a situation is the meaningful experience of a conscious present.

But is meaning always conscious meaning ? Surely not : meaning may be carried in purely physiological terms. In rapid reading, the skimming of pages in quick succession ; in the rendering of a musical composition, without hesitation or reflection, in a particular key ; in shifting from one language to another as you turn to your right- or left-hand neighbour at a dinner-table : in these and similar cases meaning has, time and time again, no discoverable representation in consciousness. The course and connection of ideas may be determined beforehand and from without ; a word, an expression of face, an inflection of the voice, a bodily attitude, presses the nervous button, and conscious-



ness is switched, automatically, into new channels. We find here an illustration of an universal law of mind, of which we shall have more to say when we come to deal with Action: the law that all conscious formations, as the life of the organism proceeds, show like phenomena of rise and fall, increase and decrease in complexity, expansion and reduction; so that, in the extreme case, what was originally a focal experience may presently lapse altogether. We learned our French and German with pains and labour; the conscious context that gave meaning to words and sentences was elaborate; but now all this context has disappeared, and a certain set of the nervous system, itself not accompanied by consciousness, gives the sounds that fall upon our ears a French-meaning, or changes us into German-speakers.

This predetermination of consciousness by influences that, during the course of consciousness, are not themselves conscious, is a fact of extreme psychological importance, and the reader should verify it from his own experience. It has a threefold bearing upon the psychological system. First, it reminds us that consciousness is a temporal affair, to be studied in longitudinal as well as in transverse section. It is part of the direct business of psychology to trace the fate of meaning from its full and complete conscious representation, through all the stages of its degeneration, to its final disappearance. Secondly, our psychology is to be explanatory, and our explanations are to be physiological (§ 9). To explain the way in which consciousness runs, the definite line that it takes, we must have recourse to physiological organisation; and the tracing of the stages of mental decay helps us to follow and understand the organising process. Thirdly, if we lose sight of nervous predisposition, we shall make grave mistakes in our psychological analysis; we shall read into mental processes characters that, in fact, they do not possess. Turn back to the simple instance given on pp. 274 f. Here we must either say that the meaning of the experi-



ment, after the week's work, is carried for the observer in purely physiological, non-conscious terms; or we must say that his observation is untrustworthy, that there is a mental context which he has overlooked. But if we take this latter alternative, we shall be constructing mind as the naturalist in the story constructed the camel; we shall be inventing, not describing.

§ 104. **The Form of Combination.** — Our account of the psychology of perception is now, in the author's view, complete. It has embraced four principal points. First, under the general laws of attention and the special laws of sensory connection, sensations are welded together, consolidated, incorporated into a group. Secondly, this group of sensations is supplemented by images. Thirdly, the supplemented group has a fringe, a background, a context; and this context is the psychological equivalent of its logical meaning. Fourthly, meaning may lapse from consciousness, and conscious context may be replaced by a non-conscious nervous set. If we translate this account into genetic terms, we have, as the earliest form of perception, some sensory complex in a kinaesthetic setting. Then comes the invasion of consciousness by images, which modify both complex and setting, and may, in course of time, largely replace the sensory elements of the one and actually displace the other. The images themselves are very far from stable; they shrink and decay; they tend, more especially, to reduce to a common denominator, to verbal ideas; a sort of symbolic shorthand supersedes the earlier picture-writing of mind. Finally, the central complex may appear as a mere skeleton of its former self, a mere indication of its primal complexity, and the setting may not appear at all; meaning may be carried in terms of physiological organisation.

There are, however, some psychologists who would not regard the account as complete. A square, they say, is more than four linear extensions, sensibly of the same length, and occupying certain relative positions in the visual field; a square is square; and squareness is a new character, common to all squares, but not to be explained by attention, or by the laws of sensory connection, or by those of imaginal supplementing. A melody, again, is more than rhythm and consonance and scale; a melody is melodic; we recognise its melodic nature as such; the melodic character is something new and unique, common to all melodies, but not found elsewhere. Hence they find it necessary to postulate "a form of combination as a distinct mental element." "The presentation of a form of synthesis," they argue, "is as distinct from the presentation of the elements combined, considered apart from their union, as the presentation of red is distinct from the presentation of green."<sup>1</sup>

In the author's judgment, this attitude betrays a confusion of the analytic and the genetic points of view. We cannot generate the square from lines, or the melody from rhythm and scale; but neither is that what we try to do. The square and the melody are given, as perceptions. Our psychological task is to analyse these given perceptions, to discover their elements, and to formulate the laws under which the elementary processes combine. That done, we can write, for 'square' and 'melody,' 'these and these elements connected in these and these uniform ways,' and we can go on to search for physiological conditions (§ 9). We have solved our problem in analytical terms; we have not first defined the terms, and then put them together to

<sup>1</sup> G. F. Stout, *Analytic Psychology*, ii., 1909, 48. Cf. i., 1896, ch. iii.

produce something that was not contained in the definition. — The author cannot, in his own introspection, identify the form of combination as a distinct mental element. It is, however, only right to say that the belief in a new mental content, or new mental character, peculiar to perception, is shared by many psychologists of standing.

#### References for Further Reading

§§ 102–104. On the general topic, see W. James, *Principles of Psychology*, i., 1890, ch. xiii. ; ii., chs. xvii., xix. ; H. Ebbinghaus, *Psychologie*, ii., 1908, § 70. On the psychology of meaning, see the author's *Lectures on the Experimental Psychology of the Thought-processes*, 1909, Lect. v. On the form of combination, see I. M. Bentley, *The Psychology of Mental Arrangement*, in *American Journal of Psychology*, xiii., 1902, 269 ff.

## ASSOCIATION

§ 105. **The Doctrine of Association.** — It often happens that we wish to recall something that we are sure we know, but that at the moment escapes us. Aristotle, in his tract *On Memory and Reminiscence*, suggests a mode of procedure for such cases: we should start out from something that is similar to the idea we want, or that is its opposite, or that has been contiguous with it in space or time.<sup>1</sup> Aristotle writes as if these ways of arousing memory were entirely familiar to his readers; and so, no doubt, they were; popular psychology is full of just such maxims (p. 286). Nevertheless, the Aristotelian rules proved to be immensely important for the future history of psychology. They were gradually transformed into laws of the association of ideas; and the association of ideas itself came to be the guiding principle of the British school of empirical psychology. So well did it work, as an instrument of psychological analysis and interpretation, that Hume compared it to the law of gravitation in physics: "here," he said, "is a kind of attraction which in the mental world will be found to have as extraordinary effects as in the natural, and to show itself in as many and as various forms."<sup>2</sup> All the great names in British psychology, from Hobbes down to Bain, are connected with this doctrine of the association of ideas.<sup>3</sup>

<sup>1</sup> W. A. Hammond, *Aristotle's Psychology*, 1902, 205.

<sup>2</sup> D. Hume, *A Treatise of Human Nature*, [1739] bk. i., pt. i., § 4.

<sup>3</sup> Let the roll be called! Thomas Hobbes, John Locke (who introduced the phrase 'association of ideas'), George Berkeley, David Hume, David Hartley (the founder of modern associationism), Thomas Brown, James Mill

There are, then, four traditional laws of association. An idea calls up or suggests another idea by similarity, by contrast, by temporal or spatial contiguity. "A picture naturally leads our thoughts to the original" (Hume): here is association by similarity. "The palace and the cottage, the cradle and the grave, the extremes of indigence and of luxurious splendour, arise, in ready succession, to the observer of either" (Brown): here is association by contrast. "From St. Andrew the mind runneth to St. Peter, because their names are read together; from St. Peter to a stone, for the same cause; from stone to foundation, because we see them together" (Hobbes): here is association by spatial and temporal coexistence. "A musician used to any tune will find that, let it but once begin in his head, the ideas of the several notes of it will follow one another orderly in his understanding" (Locke): here is association by temporal succession.

The tendency has been, however, to reduce these four laws to two, or even to one. The law of contrast, especially, has been merged in that of similarity; if things contrast, it is argued, they must be similar, at least to the extent that they belong to the same general class; black calls up white and not sour; sour calls up sweet and not black; so that association by contrast is really association by similarity. To this reduction there are two objections. First, the argument is logical and not psychological; the intervention of the class-idea is not attested by introspection. And, secondly, the contrast referred to in the one law is not on a par with the similarity referred to in the other; the contrast is, as we have already seen (pp. 232 f.), an affective opposition, whereas the similarity is ideational. Nevertheless, we can do away with the law of contrast. The cases that fall under it are simply cases in which the extremes of our experience meet, cases of contiguity. Such cases are very common: letters are printed black on white,

(the typical representative of the school), John Stuart Mill, Alexander Bain, Herbert Spencer (these three no longer pure associationists). References will be found in the arts. *Association (of ideas)* and *Associationism*, in the *Dictionary of Philosophy and Psychology*, i., 1901, 78, 80. All these men are worthy of study; only let the student beware of the fatal error that, because they read easily, they are easy reading.

the most brilliant lights give the deepest shadows, we are hungry and we eat, we feel cold and we make haste to get warm, we come to the palace through streets of mean houses, and so on. There is no need of a special law of contrast.

Again, coexistence in space means coexistence in time. Hence there is no need, either, of a special law of association by spatial contiguity ; temporal contiguity, simultaneous or successive, covers all the cases. The four laws thus become two, those of similarity and of temporal contiguity. Efforts have been made to carry the reduction still further ; we return to the point in § 107.

§ 106. **The Idea.** — According to the teaching of this book, an idea differs from a perception only by the fact that it is made up wholly of images (p. 48). Look across the room, and you perceive the table ; shut your eyes, and you ideate the table. The psychology of ideas is, therefore, so far as this difference allows, the counterpart of the psychology of perceptions. Ideas are simple or composite ; they are subject to the law of growth and decay ; they get their meaning from their context, and the context may consist of other ideas, or may be carried in physiological terms.

Now it needs but little reflection to see that these ideas are not at all the same thing as the ideas of the preceding Section. The ideas which we ourselves are defining are fluid, changeable processes, which derive their meaning from conscious context or from cortical set. The ideas which are associated, in the traditional doctrine of the association of ideas, are already meanings : the idea of the painting's original is the idea which means that original, the idea of St. Peter is the idea that means St. Peter : or rather, if one may put it clumsily for the sake of clearness, the former idea is just the *man-painted*-meaning, and the latter idea is the *St.-Peter*-meaning. Meaning here is not

the context of the idea, nor is it an external predetermination of the consciousness in which the idea occurs; meaning is idea, idea is meaning. And since meaning is stable and permanent, since the man-painted is always the same man, and St. Peter is always that identical St. Peter, the psychologists of association naturally treated the ideas also as stable and permanent; the ideas were bits of meaning, separate and impenetrable as physical atoms. It is hardly a caricature if we say that ideas were like beads, strung on the thread of association, or like steel blocks, held in certain arrangements by the magnetic force of association.

There are, in fact, two uses of the term 'association,' which are both confused and confusing in the writers of the associationist school. On the one hand, association is the gentle force of attraction inherent in an idea, the affinity of idea for idea, the tendency of one idea to suggest another; the steel blocks are magnetised from the outset. On the other hand, association is the principle of connection among ideas, is that which ties, binds, conjoins, links, couples idea with idea; and this something may be found either in the nature of the mind (the magnet) or in the nature of the brain (the string for the beads). The last conception comes very near our own;<sup>1</sup> but mark the difference! Perception is, for us, primarily, a group of sensations,—or, better, perception is such and so-many sensations found uniformly together in such-and-such ways. Association, then, will also be, for us, a group of ideas,—or, better, association will be such and so-many ideas found uniformly together in such-and-such ways. The explanation of association, like that of perception, must be

<sup>1</sup> It is because many of the conceptions of associationism are very like those of modern psychology, because the terminology is largely the same, because the writers' attitude is oftentimes, as if in despite of their associationism, the attitude of modern psychology itself, and because, nevertheless, the taint of logical construction pervades the whole of their work,—it is for these reasons that the student must read warily, with all his psychological wits about him.



sought in the nervous system. But the underlying nervous processes do not cement or string the ideas together; the ideas are found together, and the conditions under which they are found together are nervous. This is the difference.

We shall have much to say, in what follows, of the nature and behaviour of the idea. It is sufficient, just now, to have indicated its general character as a mental process, and to have shown how it differs from the idea of associationism.

§ 107. **The Law of Association.** — The traditional laws of the association of ideas are, after all, not descriptive formulas, as scientific laws must always be (p. 5), but attempts at explanation. If we say that the idea of Julius Caesar calls up the idea of Alexander the Great by similarity, we are offering the similarity of the ideas as an explanation of their concurrence in consciousness; and that road leads nowhere (p. 39). Let us try, however, to get a descriptive formula for the facts which the doctrine of association aims to explain. We then find this: that, whenever a sensory or imaginal process occurs in consciousness, there are likely to appear with it (of course, in imaginal terms) all those sensory and imaginal processes which occurred together with it in any earlier conscious present. This we may term the law of association.

That is the text: now follows the commentary. Note, first, that we have confined the sphere of the law to sensory and imaginal processes, to perceptions and ideas. Some psychologists believe that it should be extended to include the affective processes. There is, truly, no question that feelings (in the widest sense, p. 228) play a large part in the associative consciousness; only, in the author's opinion, they play this part by virtue of their sensory and imaginal components, and not in their affective character. How-

ever, so little is known about the psychology of feeling that the reader will do best to suspend judgment.

Secondly, the law has said nothing about attention. In the author's opinion, association always implies a high degree of clearness; the processes that were together in the conscious present must have been attentively together, if the law is to hold. But, again, the point is disputed, and the experimental evidence is not conclusive.

Thirdly, the law must be amplified in the following way. It is not necessary, for the reinstatement of a previous consciousness, that one of its terms should literally be repeated, in the sense of p. 19; it is enough that a process appear which is like one or other of its terms. If I meet my friend to-day, I am at once reminded of the conversation that we had at our last meeting, a month ago. But if some one shows me to-day a recent portrait of my friend, the same thing happens: 'A good picture,' I say; 'I saw him a month ago, and we had a very interesting talk.' This extension of the law of association, from psychological identity to psychological similarity, is clearly seen in young children, who call all the men of their acquaintance 'papa,' and call every animal — live animal, toy, or picture — by the first animal-name that they have learned. It must be accounted for on the hypothesis that the nervous conditions of similar ideas are in part the same, and that, the more alike the ideas, the more nearly identical are their conditions.

This mention of similarity brings us back to the discussion of § 105. Efforts have been made, we said, to reduce the two laws of contiguity and similarity to one. Now the law of contiguity can, with a little forcing, be translated into our own general law of association. Let the translation be made, and the law stands. What, then, of the law of similarity? This, be it remembered, is very different from our own amplified or extended law of association. We say that ideas may be started on the same track from similar beginnings; the old law of similarity says that the course of ideas ends with similars, that mental like attracts like. No doubt this statements holds, in the rough, of a great many instances of association: the idea of Julius Caesar does bring in its train the idea of Alexander the Great; and we have noted congruity with

the present contents of consciousness as one of the determinants of attention (p. 270). Nevertheless, all cases of similarity prove, on examination, to involve contiguity. Caesar suggests Alexander, not — it is true — by way of the class-idea 'great commander,' but simply because some component of the idea of Caesar has previously been together, in a conscious present, with that of Alexander. We may, then, if we like, say that all associations reduce to associations by contiguity, — being careful, in our own thought, to translate this law into psychological terms. On the whole, however, it is advisable to drop the traditional laws, and to retain only the formula of the text; there is a risk in pouring the new wine into the old bottle.

§ 108. **The Experimental Study of Association.** — The ideas of associationism are meanings; and meanings, from our point of view, are conscious contexts or nervous determinations of consciousness. Whichever they are, they sadly complicate enquiry into the conditions of association. We have a general law; but we want to know how it comes about, in the particular case, that this and not that idea arises on the recurrence of the other, that Caesar suggests now Alexander and now Napoleon. We want to get to the bare essentials of the association.

Some twenty-five years ago, Ebbinghaus solved this problem by the introduction of nonsense syllables. He made up over 2000 meaningless 'words,' all consisting of a vowel or diphthong between two consonants; the German language uses these combinations far less than the English. Here, then, were pure perceptions, sights and sounds that had no meaning and no associates; here was material so varied and yet so simple, so rich and yet so uniform, that experiments could be made under laboratory conditions, and the results of one experiment could be compared, directly, with the results of another. It is not too much to say that the re-

course to nonsense syllables, as means to the study of association, marks the most considerable advance, in this chapter of psychology, since the time of Aristotle.

It must not be supposed that the nonsense syllables work automatically. We are inveterately given to meaning; and the observer who sits down to learn a series for the first time shows a terrible ingenuity in reading sense into what by hypothesis is non-

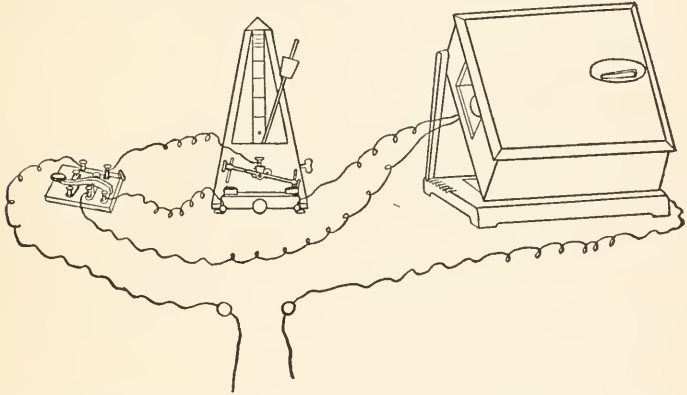

FIG. 60. Apparatus for the Serial Exposure of Nonsense Syllables. The syllables are printed upon the periphery of a cardboard disc, which is placed in the box to the right, and are viewed through the radial slit in the lid. The movement of the disc is governed by the metronome; as the pendulum swings, and electrical contact is made between the platinum strips and the mercury pools at the base of the instrument, the disc turns, with a jerk, just so far as to expose a new syllable. At the end of the series, the mechanism may be arrested by opening the key to the left. The two wires at the bottom of the figure are led to a battery. — P. Ranschburg, *Monatsschr. f. Psychiatr. u. Neurol.*, x., 1901, 321.

sense. A recent writer quotes, as a typical set of English nonsense syllables, the series: leb, rit, mon, yup, kig, des, wer, zam. But rit suggests writ, mon is Scotch for man, yup suggests yap or yelp, kig — if you have a cold — is king, wer is obviously were. And if you know anything of German, leb, des, wer, zam are directly suggestive of meaning. The series is, very certainly, not the kind of series for the beginner, who is constantly hunting about for meaningful connections. Ebbinghaus reports that the syllables dosch pä m feur löt were connected by the meaning das Brot

[Fr. pain!] Feuer löscht, the bread puts out fire. Indeed, here, as in most psychological experiments, the novice is likely to do anything rather than what is required of him; he will search for meanings, stress the position of syllables, mark the rhythm, shift his imagery (§ 114). There are great individual differences; but, in general, it is only after a good deal of practice that the observer becomes the sheer mechanical associator; and it is therefore necessary to make a careful choice of material even within the sphere of the directly meaningless. However, the observer may be trained. And methods have been worked out, for the study of association by means of nonsense syllables, that are as rigorous as those employed for the study of the intensity or quality of sensation.

Nevertheless, we cannot stop short with these nonsense syllables. The results derived from meaningless material, while they are essential to our analysis of the more complicated results from words, pictures, etc., must themselves be scrutinised in the light of the ordinary meaningful associations of everyday life;<sup>1</sup> they are fundamental, but they are also artificial; until further test, they hold only for the restricted conditions under which they are obtained. However, this work of comparison, of mutual control, offers no special difficulties; indeed, the rules discovered in the laboratory have already been applied, with success, to certain practical problems.

§ 109. **Results: the Conditions of Impression.**— Suppose that you read through a list of nonsense syllables, again and again, until you can recite it without error. The reading will have established a number of associative connections between the terms of the series. But it has also, plainly, established the terms themselves. These terms have, as stimuli, impressed the nervous system, imprinted themselves on it, stamped it in a determinate way.

<sup>1</sup> We return to this part of the subject in § 123 below.

The correct recitation depends, then, not only upon associative connections, but also upon impression. A term may be but weakly associated to its preceding term, and yet, if it has made a strong impression, — if, as we may say figuratively, its idea is almost ready to appear of itself, — may be brought to consciousness by the weak associative tendency; and, conversely, a term may be but weakly impressed upon the nervous system, and yet may be brought to consciousness by a strong associative tendency. It is impossible, in experiments of the sort under discussion, to separate the two factors in the result; the conditions of impression are also the conditions of association. We may say, however, that impression depends upon the length of the series, the position of the terms within it, the rate of succession of the terms, their grouping into complex units, the number and distribution of the readings, the active participation of the observer, and the mode (total or partial) of repetition.

Attention, we may remind the reader, is presupposed. Impression then depends, first, on the length of the series. While 6 or 7 syllables can be recited correctly after a single reading, a larger number throws the observer into confusion. The first and last terms of the series have the advantage over the others; they may, indeed, be the only terms that can be recited after a single reading of a 12-syllable series. The impression is deepest if the syllables are first presented at a moderate rate (perhaps 2 in the 1 sec.), and if this rate is slowly increased as the readings proceed. It is of assistance to introduce a subjective rhythm. Impression deepens, further, with repetition. The first reading is more important than any single later reading; after that, there is for a while little if any improvement; then the results take a sudden step up; and thenceforward progress is fairly steady until the limit of the experiment is reached. The distribution of the read-



ings in time is also of great importance : thus, it is better to distribute 24 readings in pairs to 12 days than to take them in fours on 6 days ; and it is, again, better to do this than to take them in eights on 3 days.

The same rules hold, with the necessary changes, for meaningful material. While 8 or 9 one-syllable words, and 10 or 12 figures, can be recited correctly after a single reading, a larger number brings confusion. We return to this point later (p. 387). The rate of presentation may be much quicker : in the reading of poetry, *e.g.*, 140 to 150 iambic measures in the 1 min. (4 or 5 syllables in the 1 sec.). The grouping of the material is given, not only by rhythm, but by the meaning of the successive passages.

There remain the two factors which we have called the active participation of the observer and the mode of repetition. It is found that a recitation is far more effective for impression than a reading. The reason may be, in part, that attention is greater ; in part, that the auditory and kinaesthetic stimuli reinforce the visual. It seems to the author, however, that the chief effect of the recitation is to equalise the attentions ; every term in the series must be brought out sharply and clearly ; the observer discovers his weaknesses, and has the opportunity to overcome them. Finally, it is found that connected, meaningful material is most impressive if it is read as a whole, from end to end, in the successive repetitions, while nonsense syllables and disconnected meaningful material (dates of events, words of foreign languages) are best taken discretely, read over and over a little at a time. —

The nervous modification which we have here named 'impression' is, clearly, the first term in the series of nervous changes which condition the process of learning. If we read the list of syllables again and again until we can recite it correctly, we have learned it. Learning, however, is a very complex affair, depending upon impression, upon associative tendency, upon the retentiveness of nerve-substance, and upon cortical set. Hence we have avoided the use of the word in the present Section.

§ 110. **Results: the Conditions of Associative Tendency.** — Anything that makes for the impression of two stimuli,



during the conscious present, will also serve to establish an associative tendency between them; so that the recurrence of the one, whether as perception or idea, will be likely to arouse the idea of the other. The impressing of our series of syllables has, accordingly, established certain associative tendencies. The strongest of these, as might be supposed, is that which leads from term to term in the order of presentation; but there is good reason to believe that every term is, in some measure, connected with every other term of the series.

We find in the experimental results cases of association, not only of immediately successive ideas (direct association), but also of ideas separated, within the conscious present, by other ideas (remote association); this latter is relatively weak, but it is still definitely discoverable. To put the matter in terms of the alphabet, we find associations, not only of *a* and *b*, of *b* and *c*, of *y* and *z*, but also of *a* and *d*, of *v* and *z*. And, what is more important, we find that the associative tendencies may work retroactively; there are associations of *z* with *y*, of *z* with *x*, and so forth. The series of syllables has therefore been impressed, not as an interrupted series, but as a very complicated meshwork, functionally interconnected through all its parts.

There is yet a further complication. The series is impressed upon a brain which is already the seat of a vast concourse of associative tendencies; and the incoming stimuli may thus excite to full or partial activity some preexisting tendency whose arousal was neither expected nor intended. The observers not infrequently report, *e.g.*, associations of position, of the place of a syllable in the series; the cue may be given, according to the circumstances of the experiment, by a verbal idea of number, by the spatial arrangement of the syllables, by inflection of the voice. Under certain conditions, the subarousal of such a tendency determines an association, while the place-idea does not itself appear in consciousness. Suppose that *a* is associated to *b*, *a* to *β*, and that both pairs of letters have been associated to the place-ideas first, second.

Then, in the given case, the sight of  $\alpha$  may suggest the idea of  $\beta$ , although the observer has not thought of 'first.'

*Mediate Association.* — Some psychologists believe that an association may be set up, originated, by unconscious (purely physiological) intermediaries. I examine a picture, we will say, which the artist has signed; my eyes travel over the signature, but I fail entirely to remark it. At some later time I am examining another picture, signed in the same way by the same artist; again my eyes travel over the signature, but again I fail to remark it. Nevertheless, the second picture suggests the first; the signature has impressed my brain, although it has not aroused a perception; the ideas of the two pictures are connected by this unconscious link. Here is a case of mediate association.

The question has been put to the trial of experiment, and the results are mainly negative; it is, however, so difficult to meet the conditions of a crucial test, that difference of opinion is natural and justifiable. In the author's judgment, association requires attention (p. 379); mediate association, of the kind described, does not occur. The alleged instances may be interpreted as associations whose conscious mediation (odour, organic sensation) has been overlooked, or as remote associations, or as associations due, in the way just described, to the subarousal of associative tendencies already established. A fourth possibility will be discussed later (p. 400).

If, now, a series of nonsense syllables establishes this complicated network of associative tendencies, a stanza of poetry or a paragraph of prose must set up excitations of far greater complexity. And the pattern of the excitations will vary, according as the meaningful material is familiar, and therefore throws into play a total cortical disposition, or is unfamiliar, and therefore starts up only partial and fragmentary associations. We cannot trace these effects in detail; but we have evidence both of the mutual reinforcement and of the mutual interference of associative tendencies.

We have had an instance of interference in the confusion that follows the first reading of a long series of words or syllables (pp. 383f.). So long as we are within the range of attention (§ 80), there is no difficulty. But when we pass beyond it, the law of retroactive inhibition comes into effect. The associative tendencies need a certain time to establish themselves, to settle down; and if this time is not allowed, but stimulus treads on the heels of stimulus, there is no impression of a pattern, and no associations are formed. A recently acquired association may even be abolished—as most of us know to our cost—by intensive occupation with an entirely different topic. You have just got to your point, to the phrasing, the insight, the argument, that will clinch things; you are distracted by some irrelevant business; and when you come back to your work, the point has gone. So nicely balanced and so easily disturbed are the associative tendencies, that you may never recover it; try as you will to reinstate the conditions, you cannot get the exact pattern back again. The compensation is that the tendencies, left to themselves, fall into their own patterns. School-boys, with a keen sense for economy of effort, learn their lessons only partly overnight, and trust to a hasty review in the morning; the associative tendencies work while their owners sleep. Here, too, is the secret of the practised speech-maker. Knowing that he has to talk on a certain subject at a certain date, he runs over his present ideas in ten minutes of concentrated attention, and drops them; then, on the appointed day, he finds that the associative tendencies have prepared his address.

With meaningful material, interference may arise in other ways. Take the alphabet, again: *a* is connected with *b* through the frequent repetition of *abc*, but is also connected with *z* by the phrase ‘*a* to *z*.’ Let *a* appear in consciousness; what happens? It may be promptly followed by *b* or *z*; the one of these ideas may, as we have expressed it, be more nearly ‘ready’ than the other. If the terms of the two associations are complex, the incoming idea may derive from both of them: *a* may, so to say, call up an idea that is partly *b* and partly *z*. But, if the *a*-tendency and the *z*-tendency are of approximately equal strength, they will cancel each other, and there will be no association. A question often

leaves you dumb, not because you have no answer, but because you have so many answers that no one of them can force through to expression.

This sort of interference is known as terminal inhibition, in contradistinction to another kind, which is called initial inhibition. If  $a$  is already connected with  $b$ , then it is difficult to connect it with  $k$ ;  $b$  gets in the way. You have some particular fault of style, or you have fallen into the habit of spelling wrongly some particular word; you want to correct the fault, to spell aright. But every time that you are off guard, the mistake recurs; the existing association  $a-b$  heads off the desired association  $a-k$ . This law, then, cuts across the law of remote association. The first impression of the alphabet sets up, it is true, not only the direct association  $a-b$ , but also the remote association  $a-k$ . As, however, the alphabet is more and more often repeated, the direct association more and more strongly inhibits the remote, so that it presently requires more readings to establish the connection  $a-k$  than were needed for the original connection  $a-b$ .

On the other hand, the associative tendencies may reinforce one another. Association may be convergent; a whole constellation or complex of tendencies may work together in the interests of a single idea, and this complex, as we have repeatedly seen (*e.g.*, p. 274), need not by any means appear as a whole in consciousness. Children who are brought up to speak two languages rarely mix their words; as they have begun, so do they continue, a sentence; the first utterance has behind it the directive pressure of a multitude of cooperating tendencies. More than this, association may be at first divergent, and then convergent. A perception may stir into activity a number of tendencies, or a number of constellations; and these may, in their turn, all converge upon a single idea. Here we get a glimpse into the physiological basis of conscious context, of psychological meaning (§ 103). The words of a sentence, the sentences of a paragraph, the paragraphs of a chapter, the chapters of a book, arouse innumerable tendencies in the nervous system of the reader. Sometimes a special constellation gains the upper hand, and the reader is sidetracked by his own ideas; in general, the writer has his way, and the divergent ten-

dencies are continually recombined. However, this is not the whole story of meaning; the reader's total attitude is also of great importance (§ 141).

§ III. **The Associative Consciousness.** — There are as many modes or forms of association as there are ways of being together within a conscious present. What these ways are, we already know; they have been outlined in our discussion of perception. We may say, then, that there are as many forms of association as there are forms of perception and idea; the pattern of the associative consciousness may be spatial, temporal, qualitative, or mixed. The pure perception is itself an association of sensations, and the idea is an association of images.

But is there no psychological difference between perception and idea, on the one side, and the association on the other? Not, certainly, in composition: the elementary processes that analysis reveals are the same in both, — sensations and images. Not, necessarily, in complexity: many of the instances of association given in the text-books are simpler, contain fewer elementary processes, than the more complicated perceptions. Not, again, in mode of connection of the elements: the laws governing connection are the same throughout. And not, necessarily, in closeness of this connection: the names of familiar things are as closely bound up with their perceptions as the sensory elements in the perceptions are bound together. The difference is, in fact, rather a psychologist's than a psychological difference. We must build up a psychology by stages, in orderly fashion; and it is convenient to distinguish, first, the bare elements, sensations and images; next the connection of the bare elements, perceptions and ideas; and then, later, the connections of elements that have already

been connected, the associations of ideas. If we may use a figure, which roughly expresses the truth, we can say that the elements of the perception have never been together before, while the elements of the association have manifold habits of connection already upon them.

The doctrine of association has, however, played so important a part in the history of psychology, and the influence of tradition is so strong, that many psychologists tend, as if instinctively, to differentiate the idea from the association of ideas. The tendency shows itself in two ways: first, in the overemphasis of successive, as compared with simultaneous association; and secondly, in the attempt to classify and tabulate the various forms of association.

Most students of psychology, if they hear the phrase 'association of ideas,' think at once of the successive association; and this, by its very nature as a train or succession, is more complex and more variable in its course than is the idea. Yet it is certain that the simultaneous association is the typical association, and that the successive association, as illustrated in the books, is of rare occurrence, a limiting case of association at large. "In a discourse of our present civil war," wrote Hobbes in 1651, "what could seem more impertinent than to ask, as one did, what was the value of a Roman penny? Yet the coherence to me was manifest enough. For the thought of the war introduced the thought of delivering up the king to his enemies; the thought of that brought in the thought of the delivering up of Christ; and that, again, the thought of the thirty pence, which was the price of that treason. And thence easily followed that malicious question." Here, no doubt, Hobbes has his finger on the coherence, the context. But there is just as little doubt that the psychology of the situation was widely different from his conception of it; there was no simple sequence of thought upon thought, idea upon idea. Let the reader observe for himself!

We shall not here enter upon the question of classification. The



various authors who have drawn up tables of associations have based their arrangement, almost without exception, upon logical principles, upon the meaning of the associated ideas; they have referred the associations to certain logical categories, such as subordination, coordination, cause and effect, means and end. The results may be of value for a psychology of individual differences; they have no place in a general, descriptive psychology. Moreover, associations vary with circumstances. It has been found, under experimental conditions, where a stimulus-word is given and the observer has to reply at once by naming the first word which occurs to him, that substantives are associated to substantives, adjectives to adjectives, numbers to numbers; and that the association is nearly always formed within a single sense-department, so that red calls up green, and hard, soft. But if the conditions are changed, and a little more time is allowed the observer, the character of the associated ideas is also radically changed. Fatigue, again, may bring out purely mechanical associations (snow — ball, fish — dish) which are ordinarily foreign to the observer's consciousness.

*Introspective Analysis.* — If a familiar visual stimulus (word, simple picture) is presented to the observer, with the instruction that he shall receive it passively and report the consequent course of his mental processes, the following results appear. First, there is a simultaneous association of stimulus and internal speech; the word or the pictured object is named. Thereupon follows an associative complex, which may assume any one of three principal forms. (1) The stimulus arouses, either at once or very shortly after the named perception has become clear in consciousness, and either as a whole or by way of some part or aspect, an affective process, a feeling in the widest sense (p. 228). The feeling, in turn, calls forth an associated idea, which may subsist for a time alongside of the original perception, but soon replaces it. Thus, a word printed in very small letters upon a large ground aroused the feeling of loneliness; a word printed in red, the feeling of excitement; the word 'blinding,' the feeling of a blinding light; and then the feeling itself (or, in the author's view, the kinaesthetic and other organic components of the feeling) brought up an idea which supplanted the meaning of the stimulus-word. (2) In other cases



the named perception is either supplemented or replaced by the idea of some object or picture previously seen. Thus, an outline drawing of a face may suggest the idea of a friend, whose features are then, so to speak, read into the drawing; the perception is lost or merged in a simultaneous association. Or the word 'Tell,' printed on a blue ground, calls up a familiar picture of William Tell springing from a boat to the rocks; the blue of the background becomes the blue sky of the painting. There are many intermediate forms between these extremes, as there are also between this group of associations and the next. (3) Here the stimulus arouses an idea which, at first thought, appears to be separate and detached; we have the traditional pattern of the successive association. And, occasionally, we cannot go behind that pattern; the named perception and the idea seem to be mechanically linked; we are in presence of the limiting case. Usually, however, introspection takes us farther. Thus, the outline drawing of a tent called forth the idea of a certain city market; and for a moment the observer could simply report the bare succession of the experiences. But then he found the cue: he had ridden through the market, on his bicycle, in much the same attitude in which he now sat; a massive complex of organic sensations was common to the two situations. — Observations of this sort make it quite clear that the type of association is the simultaneous association, and that successive associations — to put the matter a little paradoxically — are simply simultaneous associations drawn out in time.

If we keep strictly to the observed facts, we can find no psychological difference between the idea and the association of ideas. Still, the practical difference remains that our ideas come ready-made, whereas we can establish new associations. May not introspection show the conscious mechanism of this novel grouping? and may we not thus get fresh light on the nature of the mixed perception, and of the idea itself?

Wundt has answered these questions in the affirmative. He believes that associations are always established in the

same way, and that the machinery can be laid bare by experiment. All association, he says, is connection of elementary processes; the phrase 'association of ideas,' if it means that the ideas connect as such, is a misnomer. And the connection of elements is itself a twofold process. When a perception or idea is effective for association, its elements first arouse images that are like themselves; there is a fusion of like with like. But the terms of this fusion have been together, in former conscious presents, with other, unlike elements; the fusion is, therefore, at once supplemented; the homogeneous nucleus is surrounded by all sorts of connected processes. If the association is simultaneous, this is a full account of the matter. If it is successive, then some element in the cluster of associates about the original nucleus arouses its like; a new fusion is formed; and so the process is repeated.

Wundt's first proposition, that only the elementary components of perception and idea can enter into associative connection, is based partly upon the nature of the idea, and partly upon facts of observation. The idea is fluid, variable, instable; it does not stand still to be connected; it has no solidity, so to say, that should allow it to be coupled with another, equally solid idea. And if we observe associations under experimental conditions, we find that they hinge, in reality, not upon the ideas as wholes, but upon some simple constituent of the ideas.

This point established, we may go on to the mode of elementary connection. The first stage, the fusion of like with like, becomes clear if we translate it into physiological terms. When a complex stimulus is presented to the organism, it arouses a complex excitation in the brain. But some at least of the component stimuli have impressed the brain in the past. These stimuli, then, running into the paths of previous impression, reexcite a previous brain-activity; the other, new stimuli have to make their impression for themselves. Now, if we retranslate, we have the

conscious fact of fusion. The incoming sensation or image, if it has been in consciousness before, — and otherwise it could not be effective for association, — blends with its own image, with its rearoused self. Since the terms of this fusion are qualitatively alike, the conscious resultant is merely the element itself, given at increased intensity and with a high degree of clearness; we know, Wundt says, that the familiar elements in a complex situation stand out strongly and clearly, while the unfamiliar elements are weaker and more obscure; here, then, is evidence of the nuclear fusion. The second stage presents no difficulty. The reinforced central element, just because it has been in consciousness before, and is therefore fitted to arouse the nuclear fusion, must also stand in connection with many other elementary processes; and it is merely a matter of circumstances which of these shall actually be evoked.

What is to be said of this analysis? First, that it is by no means to be confused with the traditional doctrine of association. Wundt's fusion of like with like is not association by similarity; and his cluster of associates is not association by contiguity. Every case of associates, whether 'by similarity' or 'by contiguity,' involves, according to Wundt, both of the elementary connections: the rearousal of the like and its supplementing by the unlike. Secondly, that the analysis is, as it professes to be, an analysis of observed occurrence; it differs from the older 'laws of association,' not only in form and content, but also in derivation; it is not a product of logic, of reflection. The author offers only two criticisms. The one is, that Wundt has placed the whole mechanism of association in the realm of consciousness, whereas there seems to be no question that, in many instances, the mechanism or a good part of it is purely physiological, and finds no conscious representation at all. And the other is, that the fusion of the incoming process with its imaginal twin, while as an hypothesis it is adequate to the facts, is nevertheless not directly attested by introspection. We might, perhaps, speak of a reinstatement of the like, rather than of a fusion of like with like; the concurrence of the present excitation with the preexisting impressional tendency would then be a physiological process, to which the

emergence of the single element, strong and clear, would directly correspond; there would be no rearousal of the mental double.

The law of association (§ 107) will now operate as follows. Two nonsense syllables, let us say, are given within the same conscious present. Later, the one of them is presented alone. The single syllable, or that aspect of it (visual, auditory, kinaesthetic) which was prominent in consciousness at the time of its earlier presentation, reinstates itself; the previous impression of the nervous system makes the path of excitation easy, and the perception is clear and intensive. Along with reinstatement comes associative supplementing: the other syllable appears in imaginal form. So we have what appears to be a typical case of 'association by contiguity'; but we also see the danger (p. 380) of identifying the traditional law of contiguity with our own general law of association.

A final word of caution! We have spoken of impression, and of associative tendency, as if these things were real physiological characters. So, in one sense, they are: the nervous system behaves in certain definite ways which we are in duty bound to recognise and to name. But it must be remembered that our knowledge is altogether indirect, drawn from the results of psychological experiments. What the impression and what the associative tendency are, in themselves, — what goes on in the nervous system when a stimulus is impressed and an associative tendency established, — of all this we know nothing. The physiological explanation of association is, therefore, a problem for the future.

### References for Further Reading

§§ 105-111. H. Ebbinghaus, *Ueber das Gedächtnis*, 1885; *Psychologie*, i., 1905, 633 ff.; E. Claparède, *L'association des idées*, 1903; W. Wundt, *Physiol. Psychol.*, iii., 1903, 518 ff. For experimental methods, C. S. Myers, *A Text-book of Experimental Psychology*, 1909, 144 ff. Discussions of association which have permanent value, but which the authors would probably modify if they were writing to-day, will be found in W. James, *Principles of Psychol.*, i., 1890, 550 ff.; O. Külpe, *Outlines of Psychol.*, [1893] 1909, 169 ff.

## MEMORY AND IMAGINATION

§ 112. **Retention: the Course of the Image.** — An impression made upon a plastic substance persists, for some length of time, after the removal of the impressing object: the substance retains the impression. Suppose, then, that a stimulus has impressed the brain: the nervous substance will retain this impression after the stimulus has ceased to act. The sensation or perception will be followed by an image or idea which — if nothing interferes with it — will remain in consciousness so long as the impression retains a certain depth. What happens to it in the meanwhile, during the gradual obliteration of the impression?

The question is not easy to answer. We saw in § 60 that every stimulus of moderate intensity arouses a widespread reaction; and it is equally true that every image, auditory or visual or what not, appears in a complex mental setting. When we are dealing with sensation, our organic attitude is determined and maintained by the stimulus, which further serves to guide and correct our associations; consciousness is in relatively stable equilibrium. But, when we are dealing with image, the organic attitude is likely to vary, and the associations, being of the same mental stuff as the image, are likely to influence it in various ways. Besides, the course of an image can hardly be followed, even under the most favourable experimental conditions, for any length of time. Some new impression is sure to stamp out the old, or some new stimulus to re-arouse the preexisting tendencies of the part of the brain impressed, and the image is thus cut across and interfered with.

However, if we put together the results of investigations so far made, we may say that an image or image-complex is subject to three distinguishable modes of change: it may die away, it may approach a type, or it may be incorporated, whole or part, in new imaginal formations.

We often read of the fading and decaying of images, though we do not so often find a description of the process. If we consider the attributes of the image, it seems that those which suffer directly by lapse of time are intensity and duration; loud images become faint, bright images (p. 204) become dull, and all images flit through consciousness the more hurriedly, the farther back the original experiences lie. These are intrinsic changes, due to the weakening of the nervous impression.

Other factors, however, are at work. Thus the quality of the visual image is definitely affected by the nature of the objective illumination to which the retina is subjected: images of colours and greys tend to lighten in the light and to darken in the dark. Tonal images tend to flat, possibly because the accompanying kin-aesthetic image of laryngeal adjustment tends to weaken. More important is the gradual shift from individual quality to regional or type quality. We saw in § 107 that an association may be aroused, not only by the recurrence of a familiar idea, but also by the occurrence of a novel but similar idea; the nervous conditions of like ideas are partially the same. It appears, now, that the nervous conditions of neighbouring sensory qualities are in part the same, or at least that the impression of any one subarouses the impressions of the others. For, if a particular colour or tone is impressed, the observer soon grows doubtful of its identity; when he seeks to call it up, he may image a quality that lies at some little distance from it on the scale of colours or tones; when a slightly different colour or tone is presented, he may be misled by his image into pronouncing it the same. The image is, of course, always an individual quality, but its quality is no longer strictly correlated with that of the primary sensation.

The same result may be brought about, indirectly, by verbal



association. We may remember a colour as red, a light as dark grey, a tone as high. If we then try, at some later time, to image the colour or the light or the tone, we may image that special quality which, under the conditions of the moment, is the nearest representative of the class red, dark grey, high; that is, the quality whose image is 'readiest,' most easily evoked by the associative tendencies of the verbal idea. In such cases we may travel very far from the proper image of the primary sensation. Or, again, we may remember the original quality by absolute impression (p. 313). As our experience grows, we form in all departments ideas like the composite and standardised idea of space to which we referred in § 89; and these ideas may, like that, lapse into unconsciousness and be replaced by a cortical set, or may show only as total conscious attitudes, or may be represented on the particular occasion in some partial and fragmentary way. On its spatial side, *e.g.*, the image is mainly determined by absolute impression, so that small extensions become still smaller, and large still larger, in the corresponding images. The same influence may be traced in the case of intensity<sup>1</sup> and duration. So with quality: if the colour strikes us as a beautiful red, the light as an unusually dark grey, the tone as excruciatingly high, we shall be likely, later on, to confuse the imaged qualities with those of other, similarly impressive stimuli.

<sup>1</sup> The attribute of intensity has often been denied to the image. "The idea of the brightest radiance does not shine, that of the intensest noise does not sound" (H. Lotze, *Outlines of Psychology*, tr. 1886, 28); "the ideas of the slightest rustling and of the loudest thunder exhibit no difference in intensity whatever" (T. Ziehen, *Introd. to Physiol. Psychol.*, tr. 1895, 154). The author believes that such statements betray a form of the stimulus-error (p. 218). At all events, there is no doubt — since the experimental evidence is positive — that images have intensity. If now the image of the thunder is of long standing, and the image of rustling is recent; and if the underlying nervous impressions are allowed to fade out undisturbed; then there may come a time when the intensities are equally weak. Only under these exceptional conditions, however, can Ziehen's remark be true. And, as a rule, the image of thunder will always, whatever its age, be stronger than the image of rustling, because thunder makes on us the absolute impression of a typically loud sound, and rustling that of a typically faint, stealthy sound.



We have spoken of 'remembering' the original colour or tone by means of the class-name and the absolute impression. A discussion of the memory consciousness is not yet in place. Notice, however, that in this process of remembering the image may have disappeared altogether; it is only by accident that it can recur; in the great majority of cases it has been ousted by another image. Most images, indeed, are not allowed to live out their lives; the incoming stimuli and the preexisting tendencies of the nervous system are too much for them.

Instructive observations on the career of imaginal complexes may be made as follows. The observer draws on paper, from a copy or an object, some fairly simple figure: a fleur-de-lys, an heraldic animal. A week later, he is asked to repeat his drawing from the image of the previous drawing; a week later the same request is made, and so on. It is found that certain features of the image may disappear entirely, and that oftentimes the repeated figure tends to approach a schematic type; these results are already familiar to us. It is also found, however, that the figure may be transformed: certain principal lines of the original drop out, while certain secondary lines form associations of their own, and become dominant; so that, in course of time, the fleur-de-lys has changed, *e.g.*, into a Greek cross. The method does not permit of detailed interpretation, but it shows that an image may persist, unsuspected, in consciousness, through incorporation in a number of successive ideas.

*The Memory After-image.*—Most observers find no difficulty in passing directly—that is, after a very brief interval (p. 298)—from sensation to image; even in the case of vision, conditions may be arranged which prevent interference by after-images (pp. 68, 72). Sometimes, however, the sensation is followed by a process, lasting perhaps from 5 to 10 sec., which Fechner called the memory after-image. This is not an after-image proper: for it depends, as the image does but the after-image does not, upon the clearness of the primary sensation; it appears only if, like an image, it is sought for, called up; it is stronger and clearer after a brief observation, while the after-image is better when stimulation is prolonged; and it repeats the lights and colours of the original at a

time when the after-image, were it present, would be complementary. The memory after-image is, in fact, a sort of instantaneous photograph of the sensation or perception. It is reported by observers who have a very poor general furniture of visual imagery, and doubtless plays a larger part in the imageless than in the imaginal mind (§ 141); but many minds of the latter type possess it. We shall attempt an explanation later (§ 118).

*The Perseverative Tendency.*—Images themselves seem, at times, to crop up of their own accord; we are haunted by tunes, by tags of verse, by a picture, by the face of a drowned man; and ideas occur to us in the most incongruous way. Experiments on verbal association (pp. 274 f.) show the same phenomenon; the observer will repeat a word again and again, in his series of responses, without realising that he is obsessed by this particular associate. Grouping all these facts together, certain psychologists have concluded that the brain is the seat of what they term perseverative tendencies. The impression does not fade out steadily, but recovers itself, so to speak, from time to time and under favourable conditions, so that the idea may surge back spontaneously into consciousness.

If this hypothesis is correct, we have to distinguish three sets of nervous tendencies. First, we have the impressional tendency, which represents the 'readiness' of an idea to emerge, the distance below the conscious limen at which its excitatory process is now going on. Secondly, we have the associative tendency, which represents the strength of the connection between one impression and another, or the degree of excitation that will accrue to the one when the other is reexcited. Thirdly, we have the perseverative tendency, which is a sort of rhythm imposed on the impressional tendency, such that the idea does, now and again, emerge without the aid of the associative tendencies.

Why, then, should we separate impressional and perseverative tendency? Why should we not say, at once, that the impressional tendency varies, oscillates, fluctuates? Because the status of the impressional tendency, as we have defined it, is fairly well assured, whereas the status of the perseverative tendency is doubtful. All these hauntings and recurrences may, in fact, be accounted for in

one or other of the three ways outlined on p. 386, and accounted for more satisfactorily than on the assumption of perseverative tendency. Perseveration is strongest under two, somewhat contradictory conditions: immediately after the original perception, and during the onset of fatigue. In the former event, both the impressional and associative tendencies will be strong, so that there is little to choose between the alternative explanations. But in the second case, of fatigue, it is not easy to see how the perseverative tendency should be set in operation, whereas it is natural that the more ingrained, more permanent associative tendencies should alone remain active, and that the range of consciousness should thus be restricted.

There is, then, no harm in keeping the terms 'perseveration' and 'perseverative tendency' to designate a certain mode of behaviour of images and a certain part-problem of nervous retention. But there is, in the author's opinion, no positive evidence that the behaviour is unique, or the problem insoluble by appeal to impressional and associative tendencies.

§ 113. **Retention: The Process of Dissociation.**—The association, like the image, is retained for a time; the associative tendencies persist along with the impressions. But an association, if left to itself, soon begins to break up; the associative tendencies weaken, at first quickly, then more and more slowly, until finally they cease, so far as consciousness is concerned, to act at all. It is possible, by means of nonsense syllables, to trace out this process of dissociation, and it is also possible to determine, by variation of the experimental conditions, what are the principal influences that make for permanent retention.

The use of nonsense syllables permits us to follow the associative tendencies from their first establishment to their final decay; there is practically no danger of reinforcement or of inhibition in the intervals of the experiment. It seems certain that these limited and clean-cut tendencies do, in time, disappear; they die

of old age. The much more complicated tendencies established by meaningful material seem, on the other hand, to persist, below the limen of consciousness, for very long periods, possibly throughout the individual life. We learn poems, in childhood, which we may never think of again until we find our own children learning them twenty or thirty years later. We try our memory, and discover that, except for a tag here and a tag there, we have forgotten everything. Nevertheless, if we sit down to memorise one of these old poems and another, new poem of the same length, the same metrical form, and the same level of imagination, we regain the old with considerably fewer readings than must be given to the new; the associative tendencies were there, in subliminal degree, although the associations had long since vanished. Childhood, of course, is a plastic period; the original impressions were deep, and the original associations were little interfered with. But even if the experiment is transferred to adult life, the associative tendencies show an extraordinary persistence. Ebbinghaus learned some stanzas of Byron's "Don Juan" in his thirty-sixth year, and did not look at them again for twenty-two years. He had completely forgotten them, but he found evidence that the associative tendencies had not died out.

It has been shown, by the experiments with nonsense syllables, that, if two associative tendencies are of the same strength but of different ages, a repetition of the association has the greater value for the older-established tendencies. Hence the advantage of distributing in time the readings of the material to be memorised (§ 109); the associations that are strengthened by the successive readings are older than they would be were the readings massed together. The explanation appears to be as follows. Remote and retroactive associations disappear more quickly than direct associations. The successive readings will therefore sustain and reinforce the direct associations, while they may have actually to reestablish the others; the benefit of the readings will fall mainly to the direct associations. Distribution in time thus plays directly into the hands of the law of initial inhibition. Contrariwise, the massing of the readings will keep the secondary associations alive, and in so far will delay the action of the law.

§ 114. **Retention: Individual Differences.** — The image is a later development than the sensation, and we may expect, accordingly, that it will show a greater individual variation. The psychology of sensation is concerned primarily with uniformities; all those who possess normal sense-organs have the same general endowment of sensations; and we refer striking peculiarities like colour-blindness, tone deafness, insensitivity to pitch differences, — we refer these peculiarities, when they appear, to some abnormality of the organ. The psychology of the image, on the other hand, is essentially an individual psychology. The normal brain is a much more variable thing than the normal sense-organ, and the ideas of different minds are constituted in very different ways.

Attempts have been made to reduce these differences to order, and to classify observers in terms of their imaginal type. Four principal modes of ideation have thus been distinguished: the visual, the auditory-kinaesthetic, the kinaesthetic, and the mixed. The visually minded observer, for instance, retains his experiences in terms of visual imagery; his perceptions, of whatever kind, are translated into visual ideas. An observer of the mixed type repeats in image what he has received in sensation, though he will probably have a certain leaning towards a particular class of images. It seems that there is no pure auditory type, and no visual-kinaesthetic type; at any rate, these cases are exceptional. Words are retained in similarly characteristic forms: as visual, and as auditory-kinaesthetic images. It is probable, again, that the auditory-kinaesthetic elements do not occur separately, although the emphasis may be preponderantly upon the one or the other.

While, however, these gross differences undoubtedly exist, generalisation must not be pushed too far. Thus, we cannot argue from verbal to total type; a man may image words as auditory-kinaesthetic, and yet be, on the whole, visually minded. Indeed, it may be questioned whether, apart from the mixed mode of imagery, a total type can be said to exist at all; the imagery of a given observer will vary both with the manner of presentation of the original material, and with the purpose or intention with which the material is approached. We might, perhaps, sum up the situation by saying that individuals are predisposed for different kinds of imagery; that, as a rule, the predisposition represents a line of naturally least resistance, but does not prevent the opening of other lines (by the nature of the stimulus, by special cortical set); and that, in certain cases, the predisposition is exclusive and supreme.

We made a brief reference to imaginal type on p. 199. The subject is, evidently, of great importance for education as well as for psychology; it has therefore received much attention, and many methods for the determination of type have been devised and applied. The principal result of the investigations is the proof that type is far more variable and more complex than had at first been supposed. Two points, in particular, may here be mentioned. The first is that the presence of imagery does not necessarily imply the use of imagery; my mind may be full, e.g., of visual images, and yet I may habitually mean and understand, think and remember, in other than visual terms. And the second is that a man's talent, or his choice of a profession, is no indication of his imaginal type. "I should have thought," remarks Galton, "that the faculty [of visualisation] would be common among geometers, but many of the highest seem able somehow to get on without much of it." "I am myself a good draughtsman," says James, "and have a very lively interest in pictures, statues, architecture, and decoration. But I am an ex-



tremely poor visualiser"; and Galton tells us that "men who declare themselves entirely deficient in the power of seeing mental pictures can become painters" of acknowledged rank. The author knows a musician who has no tonal images whatever; ask him to go to the piano and play a certain composition, and he will do so; ask him if he can imagine what he is going to play, and he will reply, 'No! but I am going to play it.' On the other hand, the author himself, who is no musician, is rarely if ever free from musical imagery.

While these cautions are in place, it should be added that the trend of imaginal type shows itself in various, fairly obvious ways. The attitude of attention is different, according as one is visual or auditory-kinaesthetic; and the mode of recitation differs, being slow and systematic in the former case, quick and impulsive in the latter, while the mistakes made are in both instances characteristic. A preponderant type may be traced in an author's style; and it has been suggested that the cardinal doctrines of the traditional British psychology (§ 105) are to be explained by the fact, evident from their books, that the writers were predominantly visual-minded.

There are also marked individual differences of association. Observers in the psychological laboratory fall, as do children in the schoolroom, into two great groups: the quick learners and the slow learners. Popular psychology has been all on the side of the slow pupil; if he is slow, he is also sure; his knowledge is solidly established; while his more active-minded companion is pronounced shallow; his knowledge goes as easily as it comes. Retention, we have no need to insist, is a very complicated matter, and there may very well be conditions under which popular psychology is right. Experiments seem to show, however, that at least under certain circumstances it is definitely wrong. The quick learner appears to retain as well as the slow; he has the advantage at the start, and he loses nothing by lapse of time.



The results of these experiments throw some light on the nature of cramming, which has for the most part been roundly condemned by educators. Against cramming it may be urged that the hasty impression of a mass of heterogeneous material cannot be lasting; the law of retroactive inhibition will come into play, to weaken the associative tendencies. The student who crams trusts to recency of experience to carry him through; he hopes that a certain amount of his reading will cling to him just for the day or two that he needs it. "Speedy oblivion," says James, "is the almost inevitable fate of all that is committed to memory in this simple way."

Even so, one might rejoin that speedy oblivion is not in itself a disadvantage; a good deal that we are obliged to learn at school is better forgotten. But, that aside, the argument against cramming misses the point that there are two kinds of cramming, a good as well as a bad. If we wish to remember, we must submit to the laws of memory; and bad cramming simply ignores those laws. Good cramming, on the other hand, is a very valuable asset of the quick learner. It is "the rapid acquisition of a series of facts, the vigorous getting up of a case, in order to exhibit well-trained powers of comprehension";<sup>1</sup> it is precisely the thing that the lawyer, the lecturer, the teacher, the politician, the administrator find necessary to success. Moreover, good cramming is itself of two kinds: we may cram with intent to remember, and we may cram with intent to forget. Both forms are useful, *e.g.*, to the teacher: the one provides him with the expert's knowledge of the details of his subject; the other prevents his teaching from becoming cut and dried.

As with cramming, so with skimming: it is generally reprobated. Yet it is surprising how accurate a knowledge may be acquired by hurried, selective reading, if only one has had sufficient practice. The predisposition to quick learning must, of course, be present. What that is, in physiological terms, we do not know; but it is, at any rate, a gift, like mathematical ability or a singing voice, and should be utilised rather than disparaged.

<sup>1</sup> W. S. Jevons, *Cram*, in *Mind*, O. S. ii., 1877, 193 ff.

§ 115. **The Recognitive Consciousness.** — Suppose that you are entering a street-car. As you enter, you run your eyes over the line of faces before you. The first half dozen of your fellow-passengers are strangers; their faces arouse no interest, do not arrest your gaze. At the end of the car, however, you see someone whom you know; you recognise him. A sudden change occurs in consciousness: you call him by name, take a seat at his side, and begin to converse with him. What was it, now, that happened in consciousness at the moment of recognition? What are the conscious processes involved in recognising?

To answer these questions we must recur to facts that we already know. The first is the fact that every sensory stimulus of moderate intensity arouses a widespread organic reaction (§ 60); an illustration is given on p. 194. The second is the fact that the organism not only senses, but also feels; sensory stimuli do more than arouse the sensation and the associative and organic reaction; they set up feelings as well (§ 68). These secondary effects of stimulation give us the key to the psychology of recognition. The repeated stimulus is felt otherwise than the novel stimulus, and the feeling of familiarity, as we may call it, is the essential factor in recognising; whenever it appears, we recognise; where it does not appear, we fail to recognise. The sensations and ideas of the associative and organic reaction then serve to make the recognition definite; the perception comes to us, not merely as familiar, but with the especial familiarity of a named, placed, and dated experience.

The reaction set up by a stimulus consists in part of associated ideas, in part of kinæsthetic and other organic complexes. It is tempting to suppose that the associated ideas help to constitute recognition. They may, indeed, as we shall see in a moment, be

the means to recognition; and some of them — more particularly the direct verbal associate, the name — seem oftentimes to be bound up with the actual process of recognising. Nevertheless, the experimental evidence is against them. Recognition is possible in the absence of any associated idea whatsoever; and a perception may call up objectively correct associates and still not be recognised.

In the case of the organic complexes, decision is more difficult. We have introspective warrant for believing that they enable us to recognise the perception as that special perception. Whether they enter into the process of recognising is difficult to say, because they blend with the organic complexes comprised in the feeling of familiarity. So far as it goes, the evidence is also against them; recognition, as such, seems to be wholly a matter of the feeling.

What, then, is this feeling? In experiments upon recognition it is variously reported as a glow of warmth, a sense of ownership, a feeling of intimacy, a sense of being at home, a feeling of ease, a comfortable feeling. It is a feeling in the narrower sense (p. 228), pleasurable in its affective quality, diffusively organic in its sensory character. That is all that analysis can tell us about it. If we allow ourselves to speculate, we may go further, and find a genetic sanction for its peculiar warmth and diffusion; we may suppose that it is a weakened survival of the emotion of relief, of fear unfulfilled. To an animal so defenceless as was primitive man, the strange must always have been cause for anxiety; 'fear' is, by its etymology, the emotion of the 'farer,' of the traveller away from home. The bodily attitude which expresses recognition is, on this view, still the attitude of relief from tension, of ease and confidence.<sup>1</sup>

<sup>1</sup> Speculations of this sort are permissible in psychology, but must be admitted only very cautiously into one's psychological thinking; their value depends partly upon their explanatory power, partly upon their agreement with what we know, or on other grounds can infer, of the nature of primitive mind; they are always speculations. It is clear that they involve the great question of biological heredity, into which it is here impossible to enter. The author can do no more than point out that they do not necessarily involve the direct transmission of mind, or of mental traits, from generation to generation; still less, the transmission of acquired characters.

It must be added that some psychologists refuse to recognise the feeling of familiarity as a feeling, and regard it rather as a form of combination (§ 104), an ultimate and underivable mental character; they speak of it as the quality of familiarity. There are, indeed, border-line experiences between recognition proper and direct apprehension (which we discuss below), where analysis is well-nigh impossible. But the author has read many thousands of introspective reports upon recognition, and has never yet found an observer to whom the feeling of familiarity appeared as unanalysable.

*Definite and Indefinite Recognition.*—Recognition appears in two typical forms, which nevertheless grade into each other through various intermediate stages. It is indefinite when the feeling of familiarity comes up alone; when, *e.g.*, we pass some one in the street, and say to our companion, ‘I’m sure I know that face!’ Somewhat more definite are the cases of recognition in which the feeling of familiarity expresses itself by a general classificatory term. As we glance down the line of strangers in the street-car, we may think to ourselves, ‘Doctor,—farmer,—commercial traveller.’ Lastly, recognition may be definite: the reinstatement of the organic reaction, or the arousal of a group of associated ideas, or both of these supplements together, may refer the present experience, unequivocally, to an incident of the past. In the gross recognitions of everyday life there is usually some constellation of associated ideas that is evoked by the perception; in the recognitions of the laboratory, the recurrence of the organic reaction makes the stimulus—as the reports phrase it—‘stand out,’ makes it ‘easy to grasp,’ gives it a direct ‘appeal’ to consciousness; it is then identified as the stimulus that was presented before.

*Direct and Indirect Recognition.*—When we classify recognitions as definite and indefinite, we are thinking of them as already completed. If we look at their temporal course, the way in which they are effected, we get a new ground of classification. Recognition is direct or immediate when the perception at once, of itself, calls up the recognitive feeling. Recognition is indirect or mediate when the feeling attaches, not directly to the perception,

but to some associate of the perception. We pass a stranger on the street; but we are suddenly hailed by a familiar voice, and the stranger is himself recognised as an old friend. We try to find our host's face in a group-photograph of schoolboys, and we are wholly puzzled to identify him. The face is pointed out, and recognition follows; the photograph grows more and more like, the more closely we examine it. In many instances of this sort the recognitive consciousness shows a high degree of complexity. Thus, we may be quite sure that the stranger is our old friend, and yet continue to recognise nothing about him but his voice; the feeling of familiarity alternates with the feeling of strangeness, and the play of association becomes extremely complicated. In principle, however, the conscious mechanism of recognition is the same throughout.

*Lack of Recognition.*— Failure to recognise is not a mere absence of recognition, a conscious blank; it is a positive experience. The unfamiliar perception, like the familiar, stands out clear in the focus of consciousness, but its setting is different. It is not easy to grasp, and it makes no appeal; it is accompanied by a feeling of strangeness, and by a general attitude of consciousness which we may call the attitude of search or enquiry. We may guess that the feeling of strangeness is the modern representative of primitive man's anxiety in face of the unknown; it is an uneasy restlessness, distinctly unpleasant (p. 269). The conscious attitudes will occupy us later (§ 141).

§ 116. **Recognition and Direct Apprehension.**— The nervous system as a whole, no less than the various sense-organs, adapts itself to repeated stimuli. Affective processes, as we know (§ 69), show this phenomenon of adaptation; pleasantness and unpleasantness fade out into indifference. And the organic stir aroused by an affective stimulus is more and more reduced, until it disappears altogether.

It is not to be expected, then, that the feeling of familiarity will persist unchanged, as perceptions are repeated.

We can, in fact, hardly be said to recognise the clothes that we put on every morning, or the pen with which we are accustomed to write; we take them for granted. When familiarity has gone thus far, when the familiar has ceased to evoke an organic reaction and to be pleasant, we say that recognition has passed into direct apprehension.

We have here an instance of the operation of a psychological law to which reference was made in § 103, the universal law of mental growth and decay. Just as meaning may cease to be conscious, and may be carried in purely physiological terms, so may recognition be reduced from a conscious process to an unconscious cortical set. Between the two extremes there are, naturally, many intermediates. The feeling of familiarity, the feeling of being at home, changes first to something that is still feeling, though much weaker on the affective and much less clear upon the sensory side,—to what we may describe as an ‘of course’ feeling, which is still some distance removed from sheer indifference. As time goes on, this of-course feeling itself dies out; the affective adaptation reaches its term, and the perception fails to arouse any organic reaction.

In the author’s opinion, the shift from consciousness to unconsciousness may be complete. Some psychologists, however, believe that direct apprehension always involves consciousness. We not only perceive objects by eye or ear; we move to them, turn to them, stand or sit to them, handle them. Hence, although the feeling of familiarity has disappeared, the sight or sound will throw us into a certain bodily attitude, whose sensory or imaginal representation constitutes our apprehension of the object. That is the theory. The author’s principal objection to it is that it appears to confuse recognition with meaning. The essential thing in recognition, as experiments prove, is a feeling, the feeling of familiarity; the associated sensations arising from bodily attitude, from action upon the object, may help to render recognition definite, but do not constitute recognition. We can hardly argue, then, that these sensations constitute recognition (direct apprehension).



prehension) after the loss of the feeling. Kinaesthetic contexts are common vehicles of meaning; they may constitute an object a pen, or even — in a certain sense — my pen; they cannot constitute it my familiar pen. It is not difficult to make the objection concrete. An old suit of clothes goes to the cleaner, an old typewriter goes to the repairer. We say, on their return, that the clothes must be ours, because they slip on so easily, and that the machine must be ours, because we work it so readily; but, we add, we should never have recognised them as ours. That is, the kinaesthetic complexes give them meaning, even a definite reference to our own past; but they do not, of necessity, involve recognition. And if that is true, there is no reason why they should involve or constitute direct apprehension, which, by hypothesis, is the descendant of recognition. The theory implies that, when the feeling of familiarity is gone, nothing but meaning remains; the author holds that direct apprehension is not identical with meaning.

Another and more general objection is that there are many perceptions in which kinaesthesia is not noticeably concerned. I see the same landscape every day from my bedroom window, and I apprehend it directly as that same landscape. It is true that I look at it, turn to it; but I look at it from many angles, with head and eyes in various positions, so that the kinaesthetic components must, at the best, be extremely variable; and, as a matter of fact, the eye-movements are rarely conscious, and the sensations due to movements of head and body are usually incorporated in other perceptions. It seems impossible that a kinaesthetic complex can constitute my direct apprehension of the landscape. Moreover, there are cases of direct apprehension, under laboratory conditions, in which no trace of kinaesthesia can be discovered.

*Disturbance of Apprehension.* — It is interesting to note what happens in consciousness if direct apprehension is for some reason prevented. We look at our inkstand, and find that the pen which we always keep in it has disappeared; or we glance round the breakfast room, and discover that a picture which always hangs on a certain wall is absent. We have not been in the habit of recognising pen and picture; they are too familiar. But now that they are



gone, the situation jars upon us ; we have a feeling of helplessness or of unpleasant surprise. This observation is itself important : it shows that, when the organism has become adapted to a certain complex of stimuli, the maintenance of adaptation depends upon the persistence of the complex ; a negative change, a subtraction of stimuli, creates a new situation, to which the organism reacts as a whole. There is, however, another side to the case which is, perhaps, still more important. At the moment of conscious disturbance, before the unpleasant feeling has arisen, the of-course feeling springs up in unusual strength ; it is as if, for a brief space, we reverted in imagination to a recognition of the missing object. The feeling is not intensive if measured by any absolute standard, not as strong as the feeling of familiarity proper ; but it is more pronounced than in the ordinary intermediate forms that connect recognition with direct apprehension. Here, then, is opportunity for the introspection of an elusive process, the conditions of whose appearance are otherwise not easy to arrange.

§ 117. **The Memory Consciousness.** — Hitherto we have said nothing of the conscious side of memory. We have spoken of impression, associative tendency, retention, and we have spoken of image, idea, and the association of ideas ; but no image or idea is intrinsically a memory-image or a memory-idea, and no association necessarily wears the stamp of memory. An idea comes to us as remembered only if it comes to us as consciously familiar. And the memory consciousness is, in fact, the cognitive consciousness over again, with the sole difference that the focal process, the process remembered, is an idea and not a perception. An idea is a memory if it is accompanied by the feeling of familiarity ; and an idea is specifically remembered if it is placed and dated by the organic reaction and by associated ideas.

The consciousness in which the memory-idea is set may show the pattern either of primary or of secondary atten-

tion (pp. 275 f.), and we speak accordingly of passive memory or remembrance, and of active memory or recollection. Both types of consciousness are discursive; that is, are characterised by wandering of attention, shift of imagery, variable play of association. Remembrance shades off into day-dreaming or reverie, and thus into imagination; recollection shades off into search or enquiry, and thus into thought. Between the two lies a long series of intermediate forms.

The introduction of nonsense syllables, while it led us back from logical meaning to psychological fact, and so helped to break up the schematism of the traditional psychology of association, has nevertheless done psychology a certain disservice. It has tended to place the emphasis rather upon organism than upon mind; investigation has been directed to the question of what the nervous system does rather than to that of what the memory consciousness is. The knowledge thus acquired is, no doubt, of high psychological importance, and we have taken account of it in preceding Sections. But the definiteness of result, the fascination of tracing the criss-cross of associative tendencies, and the possibility of throwing the results into quantitative form, — these things have forced into the background of current interest the more immediately psychological problem of a description of the memory consciousness. Introspective studies are comparatively few, and generalisation must be premature.

However, something may be said. If we take, first, the pattern of consciousness in recollection, we find what may be figuratively described as a reconstruction along the line of least resistance. Thus, in trying to recall a group of meaningless visual forms, and to draw them from memory, the observer does not start out with a ready-made image. He may begin with a mere fragment of imagery, or with no imagery at all. As he begins to draw, the recognitive feeling at once appears, rejecting here and accepting there; and it remains in consciousness to determine the whole course of recall and the nature of the final product, as well as to

react upon that product when present in perceptual form. Another very prominent feature of the recollecting consciousness is the emotive attitude of expected ease or difficulty of recall; this also may intervene as soon as the first clue, such as an indefinite visual image of position, has arisen. The drawing, then, is not a reproduction, a copy of the original perception, mediated by retention; it is a reconstruction, a construction of a particular result that is accepted in place of the original.

If the figures to be recalled are pictures of familiar objects, the gross clue to the recollection may be given by a visual image. But the details are again worked out by a process of reconstruction. The criteria of acceptance are direct recognition of an image; relative clearness of imagery (though this is ineffective as against even a very weak recognitive feeling); absence of rival imagery; and the observer's general knowledge of the objects pictured. Here, too, we are far removed from a simple reproduction.

Nevertheless, the reconstruction follows the line of least nervous resistance. There is a tendency, so far as mental constitution permits, to recall in kind: visual perception by visual imagery, auditory perception by auditory imagery. Familiar verbal associations, especially names, are used as aids to recall. Familiar sounds are recalled by way of the kinaesthetic processes aroused in their imitation. The image tends to lose its specificity and to approach a type or mean: a voice, at first imaged in its individual timbre, is presently called up as bass or tenor only. In the recall of pictures, the observer falls into a form of the stimulus-error, and replaces the imagery of the picture by that of the object pictured.

This account, fragmentary as it is, will suffice both to indicate the general character of consciousness in recollection, and to illustrate the difficulty of adequate introspection. The observer has to describe processes of extreme complexity, and will naturally turn first to what is most emphatic or to what he is most confidently expecting. The field must be raked over again and yet again before we can be sure that we have gathered up the full introspective yield. Moreover, the observer has to report complexes that are hurrying through consciousness and changing as they go; he is therefore likely to report in large, general terms; he has no time

for analysis; he points a verbal finger at the retreating process, and therewith turns to its successor. But then every one of these, largely designated processes must be made the topic of a special analysis; so that a memory study may really set more problems than it solves. There is, indeed, a vast range of work, directly in view, that still remains to be done.

As regards the pattern of consciousness in remembrance, our data are yet more scanty. There seems to be, behind the cognitive feeling, a general emotive attitude that holds us, so to say, to the same objective situation, to the same empirical context. This attitude serves as conscious background for processes of extraordinary instability. Attention is labile and fluid; the focus of consciousness is occupied now by visual or other imagery, now by scraps of kinaesthesia, now by personal references, organic or verbal; consciousness itself contracts and expands, pauses and hurries, and shows the most abrupt changes of direction. The author is well aware that this description is both figurative and conventional. It will, however, be a long time before psychologists can offer a composite photograph of the total consciousness in remembrance.

§ 118. **The Memory-image and the Image of Imagination.**— In minds of the visual type, imaginal complexes, of the same general degree of complexity as perceptions, are of common occurrence, and may readily be aroused under experimental conditions. These complexes fall into two great groups. Some of them have a personal reference, and represent definite incidents of the observer's past experience; others lack the personal reference, and have no associations either of time or of place. The former, in other words, are what would ordinarily be termed memory-images; the latter are images of imagination.

The two kinds of images present marked differences to introspection, but the differences are precisely the reverse of what, under the influence of popular psychology, we

might expect. Popular psychology regards the memory-image as a stable copy of past perception, and the image of imagination as subject to kaleidoscopic change. In fact, it is the memory-image that varies, and the image of imagination that is stable.

The observer is placed, as he prefers, in a dark room, or in the light, facing a blank wall, and is asked to report his images as they appear; words or sentences are spoken by the experimenter, as cues for the arousal of memory and imagination. It is found that the memory-images are filmy and vaporous, that they show little or no relief and little or no diversity of light and shade, and that they are often colourless, while the images of imagination are substantial, extend into the third dimension, and are often highly coloured. The memory-images develop slowly, are liable to continual change, and last but a short time; the images of imagination present themselves at once and as wholes, change but little, if at all, and are persistent. The memory-images involve roving eye-movements and general motor restlessness; the images of imagination involve steady fixation and motor quiescence. Both images are accompanied by, or interfused with, kinaesthetic and other organic processes, but the character of the processes is different. Kinaesthesia comes in to fill out the gaps and blanks in the memory-image; the observer sometimes remarks that he can't say what he sees and what he feels. This filling or supplementing is always of an imitative sort, repeating certain phases of the original experience. In imagination, on the other hand, the organic factors are empathic:<sup>1</sup> thus, with the image of a fish, an observer reported "cool, pleasant sensations all up my arms; slippery feeling in my throat; coolness in my eyes; the object spreads all over me and I over it; it is not referred to me, but I belong to it." Finally, the image of memory brings with it the pleasurable cognitive feeling, whereas the image of imagination is set upon a background of feeling which the observers variously describe

<sup>1</sup> Empathy (a word formed on the analogy of sympathy) is the name given to that process of humanising objects, of reading or feeling ourselves into them, which we described on p. 333.

as a feeling of strangeness, of novelty, of personal detachment, of creepiness, of weirdness, of unordinariness, of peculiar discomfort.

The same phenomena recur with auditory and olfactory images. Auditory memory-images involve movements of the larynx, and olfactory memory-images involve twitchings of the nostrils, which are not found with images of imagination. In both cases, the memory-images are less substantial than the images of imagination, and run a different temporal course. The characteristic feelings, of familiarity and strangeness, appear as they do with visual images.

These are the extreme forms of the imaginal complex, the typical memory-image and the typical image of imagination. There are many intermediate forms, which seem to contain both memory and imaginative elements. In particular, the imaginal complexes which represent objects in daily use, or objects of a familiar environment, appear to pass from the memory to the imaginative form; they become stable and persistent; but they are then wholly indifferent, felt neither as familiar nor as strange. We may regard them as corresponding, in image, to the direct apprehension of perception. The author is, indeed, disposed to believe that this observation may be generalised; that all direct apprehension, in remembrance and recollection, occurs in imaginative rather than in memory terms. When we solve a geometrical problem by help of a remembered figure, or of some previous result, the figure or the result comes to us as a whole, clearly and substantially, almost as if it were a perception. There is here, of course, a danger of confusing fact with meaning; of supposing that, because the meaning of the older work is clear and permanent, therefore its representation in consciousness is also stable and substantial. Nevertheless, it seems to the author that the conscious stuff of most habitual memories is not that of the typical memory-image, but much more nearly resembles the material of the image of imagination.

Is it not something of a paradox that the memory-image should be thus variable and instable? At first thought, yes: because we are ready to accept, from popular psychol-



ogy, the notion that an image is a memory-image of itself, in its own right ; and if that were the case, the image must of necessity copy or reproduce the perception. On reflection, no : because the image is, after all, made into a memory-image by the feeling of familiarity. So there is no reason in the world why it should copy the original experience. All it has to do — if we may ourselves talk a popular psychology — is to mean that experience (the meaning is given as the context of associated ideas and attitude) and to be recognised as meaning it. Suppose for a moment that memory-images were just weaker copies of the earlier perceptions, and nothing less or more : our mental life would, so far as we can imagine it, be an inextricable confusion of photographically accurate records. It is, in reality, because the image breaks up, because nervous impressions are telescoped, short-circuited, interchanged, suppressed, that memory, as we have memory, is at all possible. The remark has often been made that, if we did not forget, we could not remember. That is true. But we may go farther and say that, if the mental image could not decay, it could not either be the conscious vehicle of memory.

On the other hand, if there is to be such a thing as imagination, then the image of imagination must be persistent and substantial. An image is, psychologically, made into an image of imagination by the feeling of strangeness. But that the image should simply mean 'something new' is not enough ; it must be something new ; it must stay to be looked at, to be described, to be expressed in artistic form ; poet and painter and sculptor would be in sorry case if their minds were whirligigs of changing imagery. Why, then, do we not have the inextricable confusion of which we spoke just now ? Because the image of imagination,



being new, has no associations; it stands singly at the focus of consciousness, as objects do that we perceive for the first time; and if it should, presently, remind us of something, the associates will be memory-images, and not other images of imagination. Besides, the image of imagination is not persistent in the sense of those weaker copies of perception with which the popular psychology of memory operates. In this respect, too, it resembles perception: it is persistent and substantial under its own conditions; but if it has once gone, it must either be rebuilt, or recalled as an image of memory.

All through this chapter of psychology we see the danger of arguing from a preconceived theory, instead of appealing directly, introspectively, to mind itself. The associationist doctrine is that recognition implies the comparison of past image with present perception; identification follows. But that is not what happens in recognition. We are taught, similarly, that the memory-image copies the original experience. It may; but as a rule, again, it does not. We are taught that the image of imagination is a restless, irresponsible thing, always in the throes of dissolution and recombination; but it is not. We are taught that mind moves, as if on stepping-stones, from idea to idea; once more, it does not. The contents of the preceding Sections are, indeed, a strong testimonial to the value of the experimental method. But for that, we should still be repeating the traditional formulas. And if the Sections are scrappy, and their generalisations uncertain, this is not the fault of the method, but merely of its recency of application.

Let us return to the images. It is clear, from what we have learned of the imaginal complexes in memory and imagination, that the elementary imaginal process, the image of § 61, has two distinct forms. On the one side stands the image that may be confused with sensation. This image appears in perception, in the memory after-image, in synaesthesia, in hallucination, in the image of imagination, in habitual memories; it moves with movements of the eyes, and may leave an after-image. On the other

side stands the image that is of filmier texture than sensation ; it appears in the memory-image, does not move with eye-movement, and leaves no after-image. To explain the occurrence of the two forms, we must assume either that there are two modes of cortical function, or that the stable image somehow involves sensory stimulation, while the instable image is wholly of central origin. The former of these alternatives is possible ; we know very little of the modes of cortical behaviour ; but the second appears to the author to be, on the whole, the more probable. A recent writer has suggested that the stable image is really a secondary sensation ; the stimulus which acts upon a sense-organ directly arouses its corresponding sensation ; but the excitation irradiates in the cortex, spreads to other sensory areas, and thus indirectly arouses other sensations. We have here, then, a theory which might replace the theory of synaesthesia outlined on p. 197. It is, however, not easy to see why the secondary sensation, which itself corresponds not to a process of peripheral stimulation but to a central excitation, and is therefore aroused in the same manner as the instable image, should appear as sensation ; and it is especially difficult to see why it should retain the sensory character when—as in the case of habitual memories, or of certain images of imagination—there is no peripheral stimulus of any kind. The author suggests that the sensory character of the stable image may be due to an actual stimulation of the sense-organ by way of the centrifugal sensory conduction-paths,—though the suggestion is worth little, so long as the conditions under which these paths are thrown into function remain obscure.

§ 119. **The Imaginative Consciousness.** — A great deal has been written about the imagination ; but, as a matter of fact, we know very little indeed of the imaginative consciousness. Most of the psychological accounts are couched in terms of some psychological theory, and most of the introspective descriptions published in support of theory were obtained from untrained observers and without sufficient control of the conditions of observation.

It seems clear that an idea comes to us as imagined only if it comes as consciously unfamiliar, with the feeling of novelty or strangeness upon it; this feeling of strangeness is as characteristic of imagination as the feeling of familiarity is of memory. The consciousness in which the idea of imagination is set may then show the pattern either of primary or of secondary attention (pp. 275 f.), and we speak accordingly of passive or reproductive, and of active, creative or constructive imagination. Both types of consciousness are integrative rather than discursive; the sphere of attention is limited, the play of association regulated. Creative imagination shades off into thought, and thus completes the psychological circle of p. 414.

Two hypotheses of the nature of the imaginative consciousness are sharply opposed in current discussion. According to the one, the imaginative idea or constellation comes as if from without, by inspiration; the poem sings itself, the painting groups and colours itself, to the mental ear and eye; imagination is a native gift or endowment that finds rather than seeks expression. According to the other, the imaginative consciousness is profusely imaginal; associations throng about the focal process; and the product of imagination is the result of choice and arrangement of these associated ideas. On the former hypothesis, the imaginatively gifted individual is the dreamer of dreams and the seer of visions; on the latter, he is the planner, the moulder, the constructor. So imagination appears now as the typically passive and now as the typically active temperament: precisely as genius is described now as the capacity of doing great things without effort, and now as the capacity for taking infinite pains. And witnesses can be brought on both sides.

We have not the data for a final characterisation. To the author, however, the psychology of imagination takes shape somewhat as follows. Behind everything lies a cortical set, a nervous bias, perhaps inherited and permanent, perhaps acquired and temporary.

This background may not appear in consciousness at all ; or it may appear as a vague, conscious attitude (passive imagination), or again as a more or less definite plan, aim, ambition, intention (active imagination). Whether conscious or not, the nervous disposition determines the course of consciousness. It also helps to initiate the imaginative complex, the first concrete clue to which usually comes, in fact, as an inspiration, a happy thought : some external situation, or some group of associative tendencies that is active at the moment, touches off the disposition, and the initial idea flashes into consciousness. Whether the idea is crude or complete, and whether the following consciousness is narrow or broad, concentrated or richly imaginal, these things depend altogether upon circumstances. If we are dealing with active imagination, the subsequent stage, in which the idea is worked up and worked over, — while, no doubt, it may be relieved here and there by other happy thoughts, — is essentially a stage of skilled labour, of secondary attention, that ends only with the expression of the idea in objective terms. Meanwhile, consciousness has been variously emotive. The imaginative ideas bring with them the feeling of strangeness. But just as the pleasantness of recognition may be lost in the stronger unpleasantness of the recognised object, so may the strangeness of imagination be lost in the pleasure of success, or merged in the stronger unpleasantness of failure ; and these feelings may themselves alternate, so that consciousness swings between the poles of affective experience. Meanwhile, also, all sorts of empathic complexes have formed about the focal processes, vivifying and personalising the partial products of the constructive effort. Whatever happens, the total consciousness is directed and regulated by the underlying nervous disposition. In memory, the observer is always within a certain universe of discourse ; there are limits, set by the fixity of the past occurrence, which he may not transgress ; but within this breadth of context he can move at will ; consciousness is discursive. In imagination, consciousness proceeds, as a whole, from the fountain-head of disposition ; there are no limits of any kind, save those of individual capacity and experience ; but the stream, whatever its volume, flows always in a determinate direction ; consciousness, as we have said, is integrative.

But what are the focal processes? One is tempted to say, off-hand, — images. And the answer is probably correct, if one may define the term ‘image.’ Oftentimes, of course, there are images in the literal sense, visual, auditory-kinaesthetic, kinaesthetic. Oftentimes there are verbal images. But the name must also be extended to processes that merely symbolise perceptual experience, and are no more like perception than the printed report of an operatic performance is like the performance. When we trace the images of imagination beyond the stage of perceptual complexity (§ 118), we find that they undergo translation and reduction: translation out of one sense-department, along the line of least nervous resistance, into another; and reduction from explicit representation to symbolism. Reduction does not mean approximation to a type; what takes place is that a mere schema, or part-aspect, or fragment of the complex comes to do shorthand service for the whole. This seems to be the truth in the text-book statements that the images of imagination tend to grow vague, general, abstract, to become shadows of their original selves. They never grow vague, in the ordinary sense of the word; on the contrary, all of them, images proper, words, and reductions, are sensory in their reality and substantialness; that is a point that we have already emphasised, and that we must by no means lose sight of; but they do become simple and conventionalised, they do tend to symbolise rather than to represent. —

The reader may be reminded that this account is tentative, and far outruns the experimental data. It has the merit of reconciling the two hypotheses mentioned at the outset, and it accords with such introspective observations as we have. It may, however, be very seriously modified by future investigation.

§ 120. **Illusions of Recognition and Memory.** — Illusory memories and recognitions are of two kinds. We may remember or recognise something which is really, objectively unfamiliar to us, and we may fail to recognise or remember something which once formed part of our experience. Both types of illusion are quite common.

Most persons, perhaps, have had occasional experience of what is called paramnesia or false recognition, a 'feeling that all this has happened before,' which persists for a few seconds in spite of the knowledge that the experience is novel. Various explanations have been offered of the phenomenon. It occurs most frequently after periods of emotional stress, or in the state of extreme mental fatigue; that is, at a time when the associative tendencies are abnormally weak. And it seems to depend, essentially, upon a disjunction of processes that are normally held together in a conscious present. Suppose the following case: you are about to cross a crowded street, and you take a hasty glance in both directions, to make sure of a safe passage. Now your attention is caught, for a moment, by the contents of a shop window; and you pause, though only for a moment, to survey the window before you actually cross the street. Paramnesia would then appear as the feeling that you had already crossed; the preliminary glance, which naturally connects with the crossing in a single, total experience, is disjoined from the crossing, through the abnormal weakness of the associative tendencies, and comes to consciousness separately as the memory of a previous passage. As you cross, you think, 'Why, I crossed this street just now: ' your nervous condition has severed two phases of a single consciousness; the one is referred to the past; and the other, under the regular laws of memory, arouses the feeling of familiarity.

The same weakening of the associative tendencies may bring it about that a familiar, meaningful word stands out as novel and meaningless. The experience is very unpleasant; but it loses its strangeness if we synthetise it experimentally. Repeat a word over and over again, with sustained attention to the auditory-kinesthetic complex. The word soon becomes meaningless; the direction of attention has given a sort of hypnotic narrowness to consciousness, the associative context of the word is cut off, and the bare perception remains.

This loss of meaning, once more, may appear on the grand scale in the state known as depersonalisation. There are moments of unusual depression or lassitude or fatigue, when the whole world about us seems new and strange, though rather negatively than



positively,—new and strange as a shadowy dream-world, where things are pictures, and men are pictured automata, and we hear and contemplate our own voice and action as foreign and indifferent spectators. Here the normal context and the normal feeling of familiarity are entirely lacking; the kinaesthetic and other organic reactions have lapsed; the cortical set that adjusts us to a world of external reality has disintegrated. We know nothing in detail of the physiological conditions of depersonalisation, but it is evidently related to the apparently opposite phenomenon of false recognition.

Other illusions of memory, which follow naturally from the course of the image and the structure of the memory consciousness, need not here be specified.

#### References for Further Reading

§§ 112–120. H. Ebbinghaus, *Psychologie*, i., 1905, 633 ff.; W. Wundt, *Physiol. Psychol.*, iii., 1903, 581 ff., 628 ff.; *Die Kunst*, 1908.

§ 112. On the course of the image, J. Philippe, *Sur les transformations de nos images mentales*, in *Revue philosophique*, xliii., Mai 1897, 481 ff. On the memory after-image, G. T. Fechner, *Elemente der Psychophysik*, ii., 1907, ch. xlv. (b). On perseverative tendency, G. E. Müller and A. Pilzecker, *Experimentelle Beiträge zur Lehre vom Gedächtniss*, 1900, 58 ff.

§ 114. F. Galton, *Inquiries into Human Faculty and its Development*, 1883 (reprinted as no. 263 of Everyman's Library); E. B. Titchener, *Experimental Psychology*, I. ii., 1901, 387 ff.; A. Fraser, *Visualisation as a Chief Source of the Psychology of Hobbes, Locke, Berkeley and Hume*, in *American Journal of Psychology*, iv., 1891, 230 ff.

§ 115. E. A. McC. Gamble and M. W. Calkins, *Die reproduzierte Vorstellung beim Wiedererkennen und beim Vergleichen*, in *Zeits. f. Psychol.*, xxxii., 1903, 177 ff.; xxxiii., 1903, 161 ff.

§ 117. Cf. a series of articles by F. Kuhlmann, in *American Journal of Psychology*, xvi., 1905, 337 ff.; *Psychol. Rev.*, xiii., 1906, 316 ff.; *Journ. Philos. Psychol. Sci. Meth.*, iv., 1907, 5 ff.; *American Journal of Psychology*, xviii., 1907, 389 ff.; xx., 1909, 194 ff.

§ 118. References to current investigation, and an account of the experiments upon which this Section is chiefly based, will be found in an article by C. W. Perky, *American Journal of Psychology*, xxi., 1910, 422 ff. On secondary sensations, see B. Sidis, *Psychol. Rev.*, xv., 1908,



44 ff., 106 ff. On centrifugal sensory conduction-paths, W. Wundt, *Princ. of Physiol. Psychol.*, i., tr. 1904, 151, 159, 182, 184, 186, 189.

§ 119. T. Ribot, *Essay on the Creative Imagination*, tr. 1906; E. Lucka, *Die Phantasie, eine psychologische Untersuchung*, 1908.

§ 120. G. Heymans, *Eine Enquête über Depersonalisation und Fausse Reconnaissance*, in *Zeits. f. Psychol.*, xxxvi., 1904, 321 ff.; xliii., 1906, 1 ff.; J. Linwurzky, *Zum Problem des falschen Wiedererkennens (déjà vu)*, in *Arch. f. d. ges. Psychol.*, xv., 1909, 256 ff.

## ACTION

§ 121. **The Reaction Experiment.** — In the year 1796, the astronomer in charge of the Greenwich Observatory<sup>1</sup> found himself obliged to dismiss an otherwise competent assistant, who, in the preceding year, had fallen into the habit of recording stellar transits some half second too late, and had now increased his error to almost a whole second. The assistant disappeared; but the error, after passing without further notice for a quarter of a century, became the topic of prolonged scientific discussion, and as the 'personal difference' or 'personal equation' gave rise to the psychological study of reaction times.

A reaction, in the technical sense in which we are here using the term, is a movement made in response to an external stimulus. A simple reaction is a movement made in direct response to such a stimulus. In the reaction experiment, we subject the observer to some prearranged form of stimulation (say, a flash of light), to which he has to reply by some prearranged movement (say, the slipping of the forefinger from the button of a telegraph key). Instruments are employed which permit us to measure the time elapsing between the exhibition of the stimulus and the performance of the answering movement. This time is named the reaction time, and, in the case of direct response, the simple reaction time.

The experiment may be made more complicated, both

<sup>1</sup> N. Maskelyne, *Astronomical Observations made at the Royal Observatory at Greenwich*, 1795, pt. iii., 339.

on the side of stimulus and on that of mode of reaction. We then have various forms of compound reaction, with the corresponding compound reaction times.

The passage of a star across the meridian was formerly determined by means of the eye and ear method. The field of the telescope is divided up, let us say, by five fine wires, set vertically and at equal distances. The middle wire corresponds to the meridian. Before putting his eye to the instrument, the observer reads off the time from a clock, and then counts the beats of the pendulum as he watches the progress of the star. He notes its position at the last beat before, and the first beat after, it crosses the middle wire, and thus estimates the time of the actual crossing. Thus, if the star is at *a* when the twelfth beat is counted, and at *b* when the thirteenth is counted, the time of transit, estimated in tenths of a second, will be so many hours, so many minutes, 12.7 seconds.

It is in estimations of this sort that the personal difference appeared. The phrase 'personal equation' arose from the customary statement of the difference in comparative terms. Thus,  $A - B = 0.8$  sec. means that the observer *A* records a transit, on the average, 0.8 sec. later than observer *B*. Here the one observer, probably the more skilled of the two, is made the standard of reference for the other. The equation evidently has only a relative value; the magnitude of *B*'s error is not determined.

The discussion of the personal difference led directly to the experiments on accommodation of attention described in § 83. It also led, indirectly, to the experiments on reaction time. For these may be regarded as absolute determinations of the error of the observer: if *A* responds to the flash of light in 290  $\sigma$  ( $1 \sigma = \frac{1}{1000}$  sec.), and *B* in 180  $\sigma$ , then we may not only write  $A - B = 110 \sigma$ , which expresses the personal equation, but may also say, absolutely, that *A* and *B* have postdated the flash of light by the

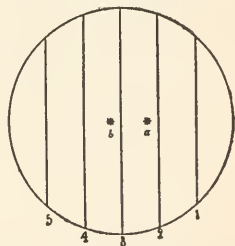

FIG. 61.

amount of their respective reaction times. Nor are we bound to the technique of the experiment as it is given in the text; the conditions of astronomical observation may be exactly repeated; an artificial star may register its own passage across the line of the meridian, and the observer may react as he would do in the case

of a real transit, recorded by the eye and ear method.

We cannot here trace the history of the reaction experiment. It must suffice to say that, as astronomy perfected its own methods, the experiment passed into the service of physiology, and was used for the determination of the velocity of the nervous impulse. The assumption was, in the rough, that if two parts of the body, at different distances from the brain, are stimulated in the same way, and the reaction times compared, the difference in these times will correspond to the difference in the length of the sensory nerve-trunks involved, and will thus show the rate of afferent nervous conduction.

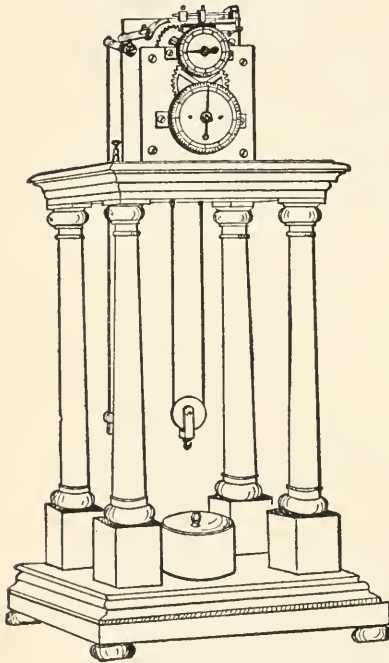

FIG. 62. Hipp's Chronoscope, an electrical clock whose unit is  $1\sigma$ : commonly employed in the reaction experiment.

It was found, however, that the method was not suited to the problem. The experiment was then transferred, as a quantitative experiment, to the psychological laboratory, and was employed, in various forms, to measure the duration of certain mental processes. But psychology knew so little of the mental processes comprised within the reaction time, that the assignment

of duration was altogether speculative. And so the experiment has now come to be, in essentials, a qualitative experiment. It allows us to repeat, over and over again, a particular type of con-

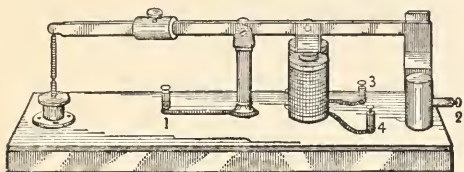

FIG. 63. Wundt's Sound Hammer, often used as stimulator in the reaction experiment. The wires of the chronoscope circuit are led to the posts 1, 2; the posts 3, 4 of the electro-magnet are in connection with a separate battery and key.

sciousness; it allows us to vary this type, in manifold ways, and still to repeat our observations as often as is necessary to their complete analysis; it thus affords an admirable control of introspection. The reaction times are then valuable, not in themselves, but as checks upon the observer. If the times of simple reaction to light are, for two normal observers and under the same conditions,  $290\sigma$  and  $180\sigma$  respectively, it is clear that we are dealing with different consciousnesses; the observers are not doing the same thing. To find out, by variation of conditions, precisely what they have been doing is a psychological problem of considerable importance. —

The technique of the reaction experiment is described in the manuals of laboratory practice, and need not here be repeated. The necessary instruments are a stimulator, a reaction key, and some form of time-measuring apparatus. Stimulators have been devised which set up a sensation in the various departments of sense, which exhibit more complex stimuli (words, geometrical

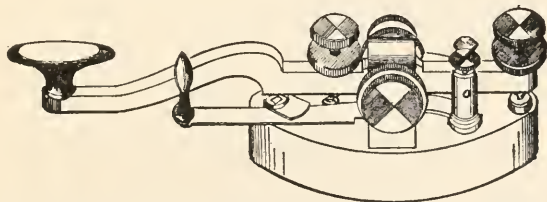

FIG. 64. Finger Key, modelled upon the ordinary telegraph key: commonly used as break-key in the reaction experiment.

figures), and which give a succession of varying stimuli (colours, noises of different intensity). Keys have been constructed for movements of the finger, foot, lips, throat, eyelid, and for selective responses, *e.g.*, for movement for any one of the ten fingers. The time-measuring apparatus ranges from the stop-watch, whose unit is  $\frac{1}{5}$  sec., through instruments of increasing accuracy, up to the electrical chronoscope, whose unit is  $1 \sigma$ .

§ 122. **The Analysis of the Simple Reaction.**—In 1887 and 1888, two investigators made the independent discovery that the length of the simple reaction time differs, according as the attention of the reactor is directed to the stimulus which is to release the reaction movement, or to that movement itself. Since the latter date, it has been customary to distinguish three types of simple reaction: the sensory, the muscular, and the mixed, — this last representing the natural attitude of a reactor whose attention is fixed preponderantly neither upon sensory stimulus nor upon movement of response, but is either distributed more or less evenly to both, or turns in quick succession from the one to the other.

The approximate times for the two extreme modes of reaction are as follows (time-unit =  $1 \sigma$ ):—

	MUSCULAR	SENSORY
Light . . . . .	180	290
Sound . . . . .	120	225
Electrical cutaneous stimulus .	105	210

The range of variation (p. 211) is, for moderately practised reactors, about  $\frac{1}{10}$  of the total sensory time, and about  $\frac{1}{12}$  of the total muscular time. The times for warmth and cold are largely dependent upon the conditions of the experiment. We may say, however, that on a rough average those for warmth approximate the times

for light, and those for cold the times for sound. The times for taste, smell and pain have not yet been standardised. The times of the mixed reaction lie between those of the extreme forms, tending to be longer or shorter according as the predisposition of the observer or the circumstances of the experiment tip the scale of attention on the side of stimulus or of movement.

The distinction of the three types of reaction is valid. But analysis has shown that the phrase 'direction of attention' is ambiguous. The course of consciousness depends entirely upon the attitude which the reactor takes to the experiment; and this attitude depends upon his understanding of the instruction given by the experimenter. Evidently, then, the instruction must be clear-cut; it must limit and restrict as well as positively command. If I say to the reactor: 'React as soon as you see the white card; keep your attention, all through, upon the card; never mind about the movement, but let that follow of itself'—if I say this, I have given instruction for the sensory type of reaction. Nevertheless, the instruction is ambiguous. For the words 'as soon as' have suggested to the reactor that he is to react as quickly as possible; and if he reacts as quickly as possible, he will tend to slur the perception of the white card, and to react upon the least perceptive cue. As the experiments proceed, he will tend, also, to prepare more and more completely for the responsive movement: and so, simply through the fault of instruction, he will shift from the sensory to the muscular form of reaction. If, again, I say to the reactor: 'React as soon as you see the white card; but keep your attention, all through, upon the movement,' my instruction is ambiguous in the opposite way. The words 'as soon as' suggest that the reaction is to follow as quickly as possible



upon the appearance of the stimulus, but the phrase 'attend to the movement' may negate that suggestion; the reactor, instead of getting the movement ready, may try to hold it clearly in consciousness, and so the response may be delayed.

It follows that the instruction must be very carefully worded; it must be brief, in order that it may be grasped as a whole; yet it must be explicit, both as to what the reactor is to do and as to what he is not to do. Moreover, it must be repeated, over and over, as the experiment proceeds, in order that the mode of reaction may not change, without the reactor's knowledge or intention, from one type to another.

The reaction experiment, as a psychological unit, may be divided into three periods: the fore-period, extending from the preliminary signal to the exhibition of the stimulus; the mid-period, extending from the appearance of the stimulus to the performance of the reaction movement; and the after-period, following upon the movement, during which the reactor makes his introspective report. The fore-period is dominated by the instruction, which may come to consciousness in very various ways. Our analyses are still far from complete; we must often be content, as in the description of memory and imagination, barely to indicate some elusive and time-worn process, whose observation demands special conditions; but the following account will suffice for a general understanding of the reaction consciousness.

We begin with the muscular reaction. In its extremest form, the instructions are represented, simply and solely, by kinaesthetic (principally strain) sensations in the reacting member (principally in the finger). These sensations appear as a contextual complex, which carries the meaning 'You are to react as quickly as possible'; they have been termed, accordingly, 'sensations of intended movement.' This restriction of consciousness, to the

apprehension of the stimulator and a kinaesthetic context, is rare. In the typical form of the muscular reaction, the sensations of intended movement are again prominent. But there are also present a conscious reference to the expected stimulus (carried by fixation of the stimulator), and a conscious connection of the expected stimulus with the intended movement. In another form, the kinaesthetic sensations are replaced by some imaginal process: a visual image of the moving finger, the word 'movement' in internal speech; while there is still a conscious reference to the expected stimulus. In a fourth form, kinaesthetic sensations and internal speech are both in evidence, but the reference to the expected stimulus may be so clear as to approximate the sensory type. Lastly, the kinaesthetic sensations and the reference to stimulus may be accompanied by 'as quickly as possible' in internal speech: the reactor intends to make the movement, as nearly as he can, simultaneous with the appearance of the stimulus.

In the extremest form of the sensory reaction, the instructions are represented, simply and solely, by the expectation (without image) of the coming stimulus. This restriction of consciousness, to the apprehension of the stimulator and an expectation context, is rare. In the typical form of the reaction, expectation of stimulus is combined with a conscious reference to the intended movement; there are, however, no sensations of intended movement. In another form, the expectation takes imaginal shape as a visual image of the stimulus, or 'now it's coming' in internal speech. The conscious reference to the intended movement is again present, but there are still no sensations of intended movement. In a fourth form, the expectation and the conscious reference are accompanied by kinaesthetic sensations in the reacting member, around the eyes, etc.; here is an approximation to the muscular type. Lastly, the expectation and the reference may be given together with 'as quickly as possible' in internal speech: the reactor intends to make the movement, as nearly as he can, simultaneous with the appearance of the stimulus. Sometimes this temporal set is represented by the visual image, *e.g.*, of a swinging pendulum.

Both kinds of instruction may, on occasion, set up consciousnesses of the pattern which they are designed to prevent: the muscular instruction may prompt to a sensory preparation, the sensory to a muscular. So flagrant a miscarriage of instruction is, of course, rare; that it occurs at all is sufficient proof of ambiguity. Since, in fact, it is not a simple 'direction of attention' that differentiates the reactions, but the reactor's attitude as conditioned on instruction, we may drop the names 'sensory' and 'muscular' altogether, and substitute for them the purely descriptive terms 'complete' and 'abbreviated.' The correct instruction for the abbreviated form would then run somewhat in this way: 'You will see a white card; react as soon as you see it; react as quickly as possible.' For the complete form: 'You will see a white card; react when you see it; do not react till you see it clearly.' And for the natural form: 'You will see a white card; react when you see it.' The first instruction definitely suggests the preparation of the responsive movement; the second as definitely suggests the clear perception of the stimulus, while it heads off the auto-suggestion that the movement is to be made as quickly as possible; the third leaves the reactor to his own devices.

When the course of consciousness has once been determined, by the reactor's acceptance of the instruction, the experiment proceeds smoothly to its conclusion. It has been suggested that the sensory reaction breaks apart; that, after the apprehension of stimulus, there is a distinct conscious impulse to move the finger; whereas, in the muscular reaction, the movement follows directly upon the perception. Introspection shows, however, that this sundering of the reaction consciousness occurs, if at all, only in the earliest stage of practice; as a rule, the finger moves as directly in the sensory as it moves in the muscular type of experiment. The difference between the two reactions is rather this: that, in the sensory, the stimulus is apprehended in its proper quality, as 'something white,'

and that, in the muscular, it is apprehended merely as a visual stimulus of indeterminate quality or, still more baldly, as 'something different.' The physiological conditions of this difference can only be guessed at.

The reinstatement, in the few minutes of the after-period, of the consciousness of the two preceding periods, has been ascribed to the operation of perseverative tendencies. We have seen, however, that the assumption of these tendencies is unnecessary (p. 400).

The simple reaction experiment can be varied in many ways. Thus, we may investigate the influence of intensity and quality of stimulus, of variation of the time allowed for accommodation of attention, of the omission of a preliminary signal, of the presence of distracting stimuli, of fatigue, of drugs. Unfortunately, the main emphasis in all this work has been laid upon the time of reaction. Since we have temporal norms for the three most accessible sense-departments (p. 432), and since our psychological analysis of the sensory and muscular reactions affords a general survey of the reaction consciousness, it is possible, by comparison of results, to estimate the effect of the changed conditions and also to trace, with some degree of probability, the changes in consciousness itself. Here as everywhere, however, we are bound, sooner or later, to face the psychological problem in detail, to push our special analyses to the bitter end. For the past two thousand years, psychology has been resting upon plausibilities and probabilities. Now that we are beginning to have a psychology of facts, it is both honesty and policy to state where the facts end and where speculative construction begins.

§ 123. **Compound Reactions.** — The simple reaction experiment may be most easily complicated by substituting for the single stimulus a number of similar stimuli. The reactor is told, for instance, that he will be shown either a black or a white card, and that he is to react when he has apprehended the white as white or the black as black; he

does not know which of the two qualities will be presented in any given experiment. Or he may be told that he will be shown a black, white, grey, or coloured card, and that he is to react when he has apprehended the particular stimulus in its proper quality. The first of these is termed, technically, the discriminative reaction, on the ground that the reactor discriminates between the two known stimuli. The second is known as the cognitive reaction, on the ground that the reactor directly apprehends—cognises rather than recognises—the quality of the unknown stimulus. In fact, however, the reactor's attitude, under the two forms of instruction, is essentially the same.

In the fore-period of the discriminative reaction, the reactor's consciousness consists, primarily, of the perception of the stimulator and of the intention to wait, to give the stimulus full time. Sometimes the names of the stimuli 'black, white' appear in internal speech; sometimes the intention is itself carried in verbal terms,—'black, white; make sure; react.' In the mid-period, the clear apprehension of the stimulus may be attended by a feeling of assent or acknowledgment, as well as by the assurance that the finger may now be moved; or the two processes may run together, as the assurance that this is the thing that was expected and that was to be reacted upon: movement then follows at once.

In the fore-period of the cognitive reaction, consciousness again consists, primarily, of the perception of the stimulator and the intention to give the stimulus full time; sometimes, however, there is diffused strain about the eyes and the upper part of the body, and a repetition of the instruction in internal speech,—'grey, colour; react quickly.' In the mid-period, the clear apprehension of the stimulus may bring with it the feeling of assent, with or without the specific name of the light or colour in internal speech; or a stimulus may be apprehended—in the precise terms of the instruction—as 'coloured'; or, again, it may be apprehended as the thing to react upon; or, finally, towards the end

of a series, as that familiar thing. Here, as in the discriminative reaction, movement follows at once upon this complex apprehension. The two modes of reaction may evidently be bracketed together.

Another method of complicating the simple reaction experiment is to vary the responsive movement. Thus, the reactor is told that he will be shown either black or white, and that he is to react only when he has apprehended the black as black or the white as white. So far the instruction is the same as that for the discriminative reaction. But further, he is to react to black by a movement of the right hand, and to white by a movement of the left hand. Or, he is to react to black by a movement of the right hand, but is not to react to white at all.

Once more: the reactor is told that he will be shown a light or a colour, and that he is to react only when he has apprehended its specific quality. So far, the instruction is the same as that for the cognitive reaction. But further, he is to react by naming the perception: that is, the responsive movement is to be different for every stimulus. Or, he is to react to the colours by naming them, but is not to react to the lights at all.

All these forms are termed, technically, choice reactions, on the ground that the reactor is called upon to make a choice, either between two different movements, or between movement and quiescence. In fact, however, the observer's attitude, under the two forms of instruction, may be widely different, and it is more than doubtful if either instruction arouses the process of choice.

It is, again, unfortunate that investigators have so far been concerned rather with the recording of times than with an analysis of



the reaction consciousness. The times themselves have been obtained under varying experimental conditions, so that their norms cannot be stated. The analytical material is very scanty.

In a series of cognitive choice reactions (white to be reacted upon, other stimuli to be disregarded), the fore-period opened with the words 'react to white; make sure' or 'right away; react to white' in internal speech; the word 'white' carried the meaning 'white and nothing else.' Later, the fixation of the stimulator set up intensive strains about the eyes, and the instruction was present to consciousness only as a general intention. If the white stimulus appeared, the mid-period showed a brief pause, culminating in the reactor's assurance that 'that's what I was waiting for,' or 'that's white all right,' whereupon the reaction movement followed at once. If some other stimulus appeared, its apprehension might connect directly with the assurance that it was not to be reacted upon; then the reactor took it quite quietly. Or — if the card was a printed card, with a white ground — sensations of intended movement might arise at the first glimpse of white, to be inhibited later, by a stronger pressure on the key, when the letters came into view.

In a series of discriminative choice reactions (visual or auditory presentation of vowels or consonants, each one of which is correlated with movement of a particular finger), the fore-period showed two main forms of conscious preparation, the sensory and the associative. The purely sensory preparation consists in attentive perception of the stimulator, with definitely directed (but imageless) expectation. This simple disposition of consciousness may be complicated either by sensations of intended movement in arms and fingers, or by the appearance of a complex visual image, a sort of monogram of the letters used as stimuli. If the reactor has not already practised the correlation, his preparation is associative: there is repetition of the instructions in internal speech, '*E* right, *O* left.' Consciousness may again be complicated, either by visual images, or by sensations of intended movement. It is noteworthy that these kinaesthetic sensations may appear, with the meaning 'right' and 'left,' not only in the corresponding arm and



fingers, but also about the eyes. We have seen that they do not necessarily lead to movement ; we now find that they are not confined to the reacting member. They are, of course, the sensations which have often been described as sensations of innervation (§ 49).

In the mid-period, the unpractised observer first apprehends the stimulus, then repeats the fitting instruction ('right,' 'left,' etc.) in internal speech, and then reacts in reponse to this associated idea. As practice advances, the associative term drops out of consciousness. Nevertheless, the reaction does not, for a long time, follow directly upon the apprehension of the stimulus ; there is, as the reactors put it, a certain resistance to be overcome before the movement can be made. This resistance has not been adequately described ; Wundt regards it as a phenomenon of motor inhibition. The movement itself is, as we said above, frequently prepared for by the sensations of intended movement, which sometimes last over into the mid-period. They are especially marked if, at the moment of apprehension of the stimulus, there is a tendency to move the wrong finger ; they are then characterised as an urgency or impulse to move in a certain way. The stimulus, however, touches off the right movement, without arousing a second kinaesthetic complex in the correlated finger. —

A word must now be said with regard to the sensations of intended movement. We have called them kinaesthetic sensations ; they appear in consciousness as a mode of kinaesthesia ; oftentimes they are referred to organs whose muscles are obviously in contraction. But there is something to be added. Their intensity may be out of all proportion to the degree of actual muscular contraction ; they may be referred to a muscle-group which, at the time, is sensibly quiescent, and whose later contraction sets up kinaesthesia of a distinguishably different kind. When they occur about the eyes, the observers insist that they are introspectively different from the kinaesthetic sensations of attentional adjustment (§ 78). Their place may be taken, in the reaction consciousness, by imaginal processes, by visual images or internal speech. It looks, then, as if they were themselves, at least in part, images rather than sensations, but images of that stable sort which

may be confused with sensations. We cannot here appeal to centrifugal sensory paths (§ 118); but we may, following Wundt, make the following tentative hypothesis regarding their central origin.

Consider, first, the ordinary mode of arousal of kinaesthetic sensations. A motor centre sends out excitations to the peripheral motor apparatus with which it is connected; the changes thus set up at the periphery stimulate the kinaesthetic organs; excitations proceed from these to the correlated sensory centres; sensation results. Now suppose that the motor centre stands in direct functional connection with the sensory centres. The excitation, instead of taking the roundabout path to the periphery and back again, may take the straight path from motor to sensory centre; the peripheral apparatus need not be disturbed. But the sensory centre, accustomed to respond to excitation by kinaesthetic sensation, will do so under the conditions of this direct excitation; kinaesthesia, of the stable sensory kind, will appear in consciousness. Ordinarily, the roundabout and the direct paths are both traversed by excitatory processes; in the case of the sensations of intended movement, only the direct path need be involved.

It must be clearly understood that the names given to these compound reactions — discriminative, cognitive, choice — are merely conventional. Discrimination and choice refer to the external arrangement of the experiment, and to that alone; in the discriminative reaction we do not discriminate, in the choice reaction we may do various things, but we do not choose. Cognition, direct apprehension, is implied in all reactions, simple and compound alike; even in the muscular reaction we cognise 'something different.' The names were given, speculatively, at a time in the history of psychology when experiment was new and analysis still a matter for the future. They have persisted, as names will; it is as difficult to dispossess them as it is to banish the terms 'active' and 'passive' from the doctrine of attention; but the reader must take them simply as

labels for certain historical forms of the reaction experiment, not as psychological rubrics.

Everything depends, we said above (p. 433), on the attitude which the reactor takes to the experiment; and this attitude itself depends on his understanding of instructions. We must now add that the carrying out of instructions, as understood, depends upon practice; the time of an elaborately planned choice reaction may, if the coordination of stimulus and movement has been sufficiently practised, be the same as that of the simple sensory reaction. It follows from these considerations that the compound reactions are not built up, piece by piece, from the simple; the discriminative and cognitive reactions are not sensory reactions lengthened by the times of discrimination and cognition; the choice reactions are not discriminative reactions lengthened by the time of choice. In other words, we cannot derive the time of discrimination by subtracting the sensory from the discriminative reaction time, or the time of choice by subtracting the discriminative from the choice reaction time. This procedure is often followed; the times of discrimination, cognition, choice are often to be found in the text-books; but there is, in fact, no truth in the underlying assumption that the reaction is a chain of separate processes, to which separate links may be added at will; the reaction is a single conscious event, conditioned as a whole upon the understanding of instructions at a given stage of practice.

A third way of complicating the simple reaction experiment is to connect the responsive movement, not directly with the stimulus, but indirectly with some associated idea aroused by the stimulus. Thus, the reactor may be told that he will be shown a printed word, and that he is to react by pronouncing the first word suggested to him by the stimulus (free association). Or he may be instructed to reply in a more definite way: by naming a subordinate idea, an instance that would fall under the stimulus-word; or a coordinate idea; or a superordinate idea, a class of

which the object denoted by the stimulus-word is a member; by associating part to whole, attribute to object, effect to cause, and so on (partially constrained associations). Or, finally, he may be instructed to reply still more definitely: to give the Latin equivalents of the English words shown, to name the capital cities of the countries, and so forth (constrained associations). It is clear that any phase of the associative consciousness may, by a fitting arrangement of the experiment, be represented in terms of objective or physical time. The reaction times have proved to be valuable both scientifically, as indicating the strength of associative tendencies, and also practically, as indicating the existence of associative connections which the reactor desires to conceal. Observation of the reaction consciousness has also thrown welcome light on the process of thought.

It would seem that here, if anywhere, the subtractive procedure is allowable; that we might, with a high degree of probability, determine the time required for association by subtracting the simple sensory from the associative reaction time. The facts are otherwise. The instruction to associate dominates the whole course of consciousness, and the two reactions are therefore incomparable.

The fore-period of the associative reaction shows the characters with which we are already familiar: attentive fixation of the stimulator, a high degree of expectation (strain sensations about the eyes and forehead and in the upper part of the body, together with holding of the breath, compression of the lips, etc.), and a representation of the instructions, usually in verbal form. The reactors also report a variety of emotive attitudes—curiosity, difficulty, impatience, coolness in the emergency—which we may ascribe to the meaningful nature of the stimuli. The mid-period of the reaction shows the characters that we have enumerated in § III, though it shows them with differences. Here, *e.g.*, the observer stands under the pressure of the coming reaction,

so that the course of consciousness is hurried and its processes are crowded together. From one point of view, this disposition of consciousness is a disadvantage; there is too much material and there is too little time for adequate introspection; the reactor falls into the way of indicating or naming large complexes that he is unable to describe. From another point of view, however, it is a distinct advantage. The observer who works under the conditions of § 111 has plenty of time for analysis, and reports his consciousness in analytical terms; there is a chance that he fail to see the wood for the trees. The observer in the associative reaction, since he has no time to describe the trees, must be content to indicate clumps and coppices; but by this very limitation he calls our attention to the fact that there are clumps and coppices, unitary complexes of manifold degrees and patterns; and these, once indicated, can be taken up for analysis under more favourable conditions.

The most important facts revealed by the associative reaction are, perhaps, those that bear upon the reactor's attitude to instruction. In the first place, the instruction, clearly conscious at the outset, presently drops out of consciousness altogether, and thenceforward directs the course of mental processes as an unconscious nervous disposition. This is, in fact, the fate of all instructions — of all suggestions, commands, cues, directions, prescriptions — to which we make habitual response (pp. 274 f.). Secondly, the instruction, if given vaguely and in general terms, is specialised, narrowed by the reactor. Though he is told to reply by the first word that crops up in his mind, he will draw his associates from those that make sense with the stimulus-word; if a meaningless associate appears, he will reject it in favour of a word whose meaning connects it with the stimulus; he has interpreted 'first word' as 'first sensible word.' Though, again, he is told that substantives will be shown, and that he is to reply by the first adjective that occurs to him, he will reply only by suitable adjectives; 'first adjective' becomes 'first fitting adjective.' It is as if we were set, or adjusted, for a world of sense, just as we are set or adjusted for a world of objective reality; to talk and think

nonsense is far less easy than we are apt to imagine. And, thirdly, — a point of great methodological interest, — the instruction to observe, to attend and report (§ 6), is eminently favourable to the review of consciousness in the after-period. If the old objection held, that introspection necessarily interferes with the very process that we are trying to observe, the observer who lay under the double instruction to associate and to introspect would be divided against himself; he would associate hesitatingly, and he would observe interruptedly. As a matter of fact, the two instructions run together, and the observer sets himself to associate as attentively and single-mindedly as he can, with the result that the course of events is clearly apprehended, and finds ready expression in words.

It has been found, in work with nonsense syllables, that those pairs have the quicker association times whose associative tendencies are the stronger and more durable, — whence it follows that, other things equal, the length of the associative reaction is an inverse measure of the strength of associative tendency. There is one case, where other things are decidedly not equal, in which this rule shows a very conspicuous breach. It has been found in work with ordinary verbal associations that, if the stimulus-word touch off what is technically called a 'complex,' either that particular reaction or the next following will show a decided lengthening. A 'complex,' in this special meaning, is the impression left upon the organism by some strongly emotive experience; it is a group of impressional and associative tendencies, which may or may not find present representation (general or partial) in consciousness, but is readily actualisable if it is not at the moment consciously actual, and whose correlated ideas tend on arousal to become focal, and to reinstate the emotion of the original experience. If, *e.g.*, I have done something of which I am ashamed, and if the stimulus-word touches off the complex of this 'deed of which I am ashamed,' then my reaction time is lengthened. This discovery is evidently of practical value, though a complete statement of the facts would require a great deal of conditioning and qualifying for which we here have no space.



In experiments of still greater complexity, the responsive movement may follow, not upon an associated idea, but upon a judgment of comparison, a literary appreciation, etc. Here, however, the times become extremely variable, and have little significance; the reaction experiment loses its distinctive character, and is merely a convenient setting for certain exercises in introspection.

§124. **Action.**—In the early days of the reaction experiment, there was little said of its psychological status, of its place in a system of psychology. The experiment was useful as measuring the objective duration of certain mental processes; but it thus appeared as a means, not as an end. Since it plainly involved a sequence of perceptions or ideas,—since the perception of one's own movement followed on that of the stimulus, or followed on an idea associated to the perception of stimulus,—it might be treated in the same chapter with association, and might be considered as a form of successive association. That settled, the writer's attention was directed to the times, not to the preparation and content of the reaction consciousness. Hence we have historical precedent for introducing the reaction, without psychological preface, simply as one of the classical experiments of experimental psychology. But we have not discussed reaction times; we have discussed the reaction. And now the question arises: What, psychologically, is this reaction?

The answer, obvious as it is, was given only in the early nineties of the last century, and still has a good deal of prejudice to overcome. The reaction is an action; it belongs to the same group of facts as reflex action, voluntary action, instinctive action. It is an action reduced, in the simple reaction experiment, to skeleton form; and it is an artificial action, made up for study under experimental con-



ditions. But it is still an action, and the consciousness which we have found to characterise it is an action consciousness.

In its most general meaning, an action is an organised movement; less generally, it is a movement of a locomotor organism; for psychological purposes (p. 16), it is primarily a human movement with some sort and degree of representation in consciousness. The qualifying words 'some sort and degree' are used advisedly; for the action consciousness is one of the most changeable and variable that we know; nowhere, perhaps, is psychology more plainly dependent upon physiology for the coherence and continuity of its descriptions (p. 40). If, however, on the ground of the foregoing analyses, we try to construct a typical action consciousness, we get something like this:

- ① a preliminary phase, in which the prominent things are kinaesthesia and the idea of end or result; a central phase, in which some object is apprehended in relation to, in the sense of, the idea of end; and a final phase, in which the perception of result is set on a background of kinaesthesia, of the sensations aroused by the actual movement. Each one of these phases may be coloured by feeling, which may itself be of either quality, pleasant or unpleasant, and of any degree of sensory or imaginal complexity.

The first phase corresponds to the fore-period of the reaction experiment. The kinaesthetic contents are, in the main, the sensations of intended movement; there may also be kinaesthetic sensations from actual, anticipatory movements, and there may possibly be kinaesthetic memories. The idea of end, or idea of result, takes the place of the conscious representation of instruction in the reaction consciousness; it may be carried in visual images, in internal speech, etc. The second phase corresponds to

②

the mid-period, in which movement is released, in the sense of the instruction, on the perception of the stimulus (perception of object). The third phase differs from the introspective after-period; the perception of result, with its kinaesthetic halo, is at once the terminus of the action consciousness and the starting-point of some new consciousness, emotive or other.

The characteristic feature of the action consciousness, as distinguished from the consciousnesses so far considered, is its predetermination in the sense of the idea of end. The presentation of the object arouses associative tendencies in the usual way; but only those tendencies are realised which lie in the line of suggestion, of the meaning of the idea of end. We translate this fact into physiology by saying that the excitatory processes underlying the idea of end set up determining tendencies; they open certain nervous channels, as it were, and close others; so that the consequent excitations find their path laid out for them. Determining tendencies thus take their place alongside of impression and of associative tendencies as nervous correlates of consciousness. We know nothing of their intimate nature; but we have ample evidence of their existence, and we name them as best we may. They are nervous coordinations and integrations, in part common to the race and transmitted from one generation to another, in part acquired in the individual lifetime, either by way of habit or under stress of some salient experience. Their influence is by no means confined to the determination of action, though here, where they find direct physiological expression in a bodily movement, it is most easily observed and traced.

We are now able to give a definition of the term 'suggestion.' It is not difficult to find a paraphrase: a suggestion is an instruction, something that comes to us with the force of a command. But

psychologists have always found it difficult to frame a definition, because there seemed to be no difference, psychologically, between the suggestive idea and any other idea. And, indeed, there is no difference; suggestion is, for us, not a descriptive, but an explanatory term; its definition is to be sought, not in psychology, but in physiology. A suggestion is any stimulus, external or internal (p. 56), accompanied or unaccompanied by consciousness, which touches off a determining tendency. The instruction to react, in the reaction experiment, sets up the determining tendency which, carrying over into the mid-period, releases the reaction movement. What sets up the readiness to accept instruction? A foregone suggestion: the observer comes into the laboratory in order to be instructed, prepared to take orders. What brings him into the laboratory? Another foregone suggestion: the desire to learn psychology, the fact that some of his friends have decided to come in. What led him to choose the particular course that includes psychology at the university? What led him to choose this particular university? What led him to enter any university? All these results are due to suggestion, to some stimulus or situation that starts up determining tendencies. The nervous system, plastic as it is, can take a set; indeed, the taking of a set is as natural to it as its general plasticity. Dr. Johnson is said to have met the arguments for idealism by kicking a stone. His action expressed a nervous set which seems to be native to the brain, a part of our endowment as human beings: the set which determines us to take the world of perception as a world of external objects, of real things. Between such tendencies as this and the passing tendency set up by the instruction of the reaction experiment there are all degrees of persistence and of specialisation.

§ 125. **The Genesis of Action.** — We have just offered a rough analysis of a typical action. Perhaps we should rather have called it a schematic action. For the typical action must be a sort of norm or standard, to which all actions approach and from which they fall away; and, in order to describe it, we must have arranged, in the order of

their relationship, the various actions that we discover in experience. Now any attempt to classify actions leads us from analysis to genesis. The action which, by its conscious representation, forms part of the subject-matter of psychology is simply a phase in a course of conscious transformation; all actions change, as conscious events, with repetition. Moreover, since the mechanism of bodily movement is in part inherited and only in part acquired, the classification of actions, if it is to be complete, takes us beyond individual development to racial evolution. We are here on very slippery ground; but it is ground which, in the present state of psychology, we are bound to traverse.

What, then, was the character of the earliest organic movements? There are two answers in current psychology and biology. The first is that consciousness is as old as animal life (p. 27), and that the first movements of the first organisms were conscious movements. This is the answer which the author accepts. The other is that consciousness appeared later than life, and that the earliest movements were accordingly unconscious movements, of the nature of the physiological reflex.

It is very important that the issue here involved be correctly understood. The alternatives are: movement with consciousness, movement without consciousness. They are not — as they are often stated to be — conscious action, mechanical reflex. All actions, biologically regarded, are 'mechanical'; all, that is, may by hypothesis be explained (and in all probability will, some day, be explained) in physico-chemical terms. The antithesis of the conscious is not the mechanical, but the unconscious action; the antithesis of the reflex is not the conscious or voluntary action, but the complex, coordinated action. A great deal of controversy would have been avoided if this elementary point had been kept clear.

The author, then, believes, with Wundt<sup>1</sup> and Ward<sup>2</sup> and Cope,<sup>3</sup> that the earliest movements were conscious movements, and that all the unconscious movements of the human organism, even the automatic movements of heart and intestines, are the descendants of past conscious movements. What is the evidence?

There is, first of all, the argument from the analogy of the individual lifetime. We learn to swim, to bicycle, to typewrite, to play a musical instrument, with conscious intent and with a constant accompaniment of consciousness; later on, if we practise enough, we do these things unconsciously. If, however, what are called 'voluntary actions' may degenerate into 'secondary reflexes' in the course of a few weeks or months or years, it is at least possible that the ingrained physiological reflexes may have a conscious ancestry in the history of the race. Secondly, there seem to be no reflexes, secondary or primary, that may not, under certain favourable conditions, be brought under cortical control and thus connected with conscious intent and accompaniment; we can all arrest our breathing, but some of us can do much more,— can modify heart-beat, expand or contract the pupil, quicken or slow the peristaltic movements. This state of things is intelligible if we interpret it as a return to a previous state, akin to the conscious direction of a bicycle, or the conscious control of movement in swimming; it is not easy to explain, if we regard the reflexes as prior to consciousness. Thirdly, there are certain reflex movements, movements that express emotion, which would be altogether unintelligible unless we could posit for them a remote conscious ancestry. The face of proud contempt reflexly 'curves a contumelious lip.' Why? "Our semi-human progenitors uncovered their canine teeth when prepared for battle, as we still do when feeling ferocious, or when merely sneering at or defying someone, without

<sup>1</sup> W. Wundt, *Physiol. Psychol.*, iii., 1903, 279; *Outlines*, tr. 1907, 213 ff. Cf. *Die Entwicklung des Willens*, in *Essays*, 1906, 318 ff.

<sup>2</sup> J. Ward, art. "Psychology," in *Encycl. Brit.*, xx., 1886, 43.

<sup>3</sup> E. D. Cope, *The Origin of the Fittest*, 1887, 395, 413, 447. Cope's essays are the more interesting, as he seems to have worked out his ideas strictly from the biological standpoint, without reference to contemporary psychology. Their biological derivation does not here concern us.

any intention of making a real attack with our teeth"; the sneer is the late and weakened form of the snarl, which meant a ripping bite at an opponent.<sup>1</sup> The thrusting forward of the head and body is a common gesture of the enraged, and appears paradoxical — since it exposes the head to a blow — unless we accept Darwin's suggestion that this, too, is a remnant of attack with the teeth. Instances of the sort might easily be multiplied. Fourthly, we may note that the primary resemble the secondary reflexes in their character as movements; they are definite, clean-cut, precise. But if this character comes in the one case with lapse of consciousness, it may have come by the same road in the other.

Here, then, is evidence from various sources: evidence that may, no doubt, be differently appreciated, but that, taken all together, makes out a fair case. On the opposite side there has been little attempt to gather special arguments. It seems natural and obvious that the simplest form of movement — the physiological reflex — should also be the earliest; it seems natural that mind, the crown and flower of life, should appear later in the history of the world than life itself; and this seeming naturalness has passed into theory as matter of fact. The view that life and mind are coeval arose, indeed, as a protest against the unproved but dominant view of the priority of unconscious movement, and the representatives of this latter standpoint have not even yet taken the challenge very seriously. If they do offer evidence for their conviction, they are likely to say that mind appeared at some time of stress, when neural tension was at its highest and neural processes were hesitant. Aside, however, from the objection that the phrases 'neural tension' and 'neural hesitation' are metaphorical only; and aside from the fact that mental processes may be exceedingly intensive on occasions when the organism is in no sort of perplexity (think of the plunge into cool water on a hot day; of the enjoyment of music after long aesthetic starvation; of our grief at the loss of a dear friend), — aside from these considerations, the question at once comes up: Whence does the organism get its capacity for

<sup>1</sup> C. Darwin, *The Expression of the Emotions in Man and Animals*, ch. x. (1890, 264). The reader may be reminded of the footnote, p. 408.



changing, under stress, from a physiological to a psychophysical organism? The organic machine has run, for a certain time, without consciousness; it is now in difficulties; it surmounts them by a neural readjustment, which is paralleled by consciousness. Must not consciousness have been present, potentially or germinally, before the difficulties appeared?

We may, of course, carry our appeal to the child and the primitive organism, and try to interpret their movements in the light of our own; this direct appeal is, indeed, imperative. But we must not expect a speedy verdict. The human infant, in particular, as the incomplete form of a very highly developed organism, embodies two courses of development, a phylogenetic and an ontogenetic, in their most complex modes. The new-born child hangs to your finger, supporting its full weight upon its arms; the boy, a few years later, will hang in like manner from the horizontal bar. Is the conscious gymnastic exercise genetically related to the first reflex grip? Yes, in some measure; both the baby and the boy are, by descent, little monkeys. But the boy does not keep the baby's reflex, and import consciousness into it; the reflex lapses, giving way to other forms of movement, — an older baby, if you give him your finger, puts it in his mouth; the boy's action is due to suggestion. So, while both performances are conditioned on racial inheritance, the later is not the direct outgrowth of the earlier, and we should go widely astray if we argued from likeness of form to continuity in ontogenesis.

Recent studies of the behaviour of the lowest organisms have led to widely divergent results, according as the investigator has made the stimulus or the organism, so to say, the unit of his work. If he keeps his attention on the stimulus, and tries to ascertain the direct effect upon movement of light, heat, gravitation, the organism may appear as a bundle of tropisms, of direct and uniform motor responses. If he keeps his attention on the organism, starts out from its total behaviour, and tries to reduce this total to a number of elementary responses, he finds that "these lower organisms furnish problems which do not differ in kind from what we find in higher animals. To the same stimuli different



organisms react differently; different individuals of the same species react differently; and even the same individual reacts differently at different times.”<sup>1</sup> The analytical method, which proceeds from total behaviour to elementary reaction, is without question, as a method of first attack, more reliable than the synthetic method, which attempts to build up a complex behaviour out of simplest elements; and we may therefore conclude that observation of the lowest organisms is at least not unfavourable to our own theory of action.

This theory finds, however, a special difficulty in the problem of the first movement of the first moving organism, — the first vital movement that was made upon the planet. By hypothesis, that movement was conscious: but how was the organism suggestible? It is the first organism; it has had no past; consciousness comes into being with its birth; how can it ‘reply’ or ‘respond’ to stimulation? We can only guess. But we may guess that a fallacy lurks in the seemingly innocent statement that the organism has had no past. We must believe that the organic arises from the inorganic, that life is derived from the not-living; but we are not bound to believe that the transition was abrupt. On the contrary, it is probable that nature (if we may speak metaphorically) made many essays at life before a stable, self-sustaining life was struck out; that there were many intermediate stages between the non-vital and the vital, many imperfect modes of half-life, part-life, which were instable and therefore transient, but which none the less bridged the gulf between the inanimate and the animate worlds. Hence the first living thing would have had a past, a half-vital ancestry; and this past would have moulded it, given it direction, rendered it susceptible on some sides and resistant on others; in a word, would have done for it, in a crude way, precisely what our ancestry does, in an indefinitely more complicated way, for ourselves. So the difficulty is met — speculatively, it is true, but by a specula-

<sup>1</sup> H. S. Jennings, *Diverse Ideals and Divergent Conclusions in the Study of Behaviour in Lower Organisms*, in *American Journal of Psychology*, xxi, 1910, 368.

Perhaps they have more

Prob  
Gates  
—  
of: P  
3  
by A.  
H. H. S.  
nyp.

tion which does not conflict with the general doctrine of organic evolution, and by speculation at all only because there is no other means of meeting it.

Let us accept the view that the first movements of the first organisms were conscious movements. What happens to the action consciousness in the course of evolution?

An examination of our own actions shows that, in the course of the individual lifetime, this consciousness takes two different roads. On the one hand, we are continually enlarging our sphere of action; conduct grows more complex; there is a tendency towards more and more complicated and specific coordination of movements; and the realisation of this tendency is always accompanied by increasing complexity of consciousness, by the mental processes and attitudes known as choice, resolve, deliberation, comparison, judgment, doubt. On the other hand, there is a tendency toward the simplification of movement, and the realisation of this tendency is accompanied by lapse of consciousness. Plasticity, that is, subsists alongside of fixity.

If, now, this analogy is to be trusted, we should expect to find the same combination, of plasticity and fixity of reaction, all through the animal kingdom. But we should expect to find the two tendencies combined in unequal measure. Man is preeminently plastic, educable in a supreme degree. We should expect that, perhaps at the other end of the organic scale, rapid fixation of movement leaves but a small margin of plasticity. We find, in fact, something much more interesting; we find that the line of animal descent bifurcates, the one branch leading to fixity with a minimum of plasticity, the other leading to

plasticity with a minimum of fixity. The action consciousness thus appears to have a double history, whose parallel chapters throw welcome light, the one upon the other.

Zoologists divide the animal kingdom into two great groups, whose lines of descent are distinct as far down as the flat-worms. The one of these leads through the unsegmented and segmented worms to the insects, spiders and crustaceans; the other leads through various invertebrate forms, largely extinct, to the vertebrates, and so finally to man. Students of animal behaviour also divide the animals into two great groups, those that are markedly plastic in their responses to stimulation, and those that are markedly fixed. The interesting point to us is that these groupings coincide. It has been seriously argued, *e.g.*, that ants and bees are pure automata, mindless reflex machines; and though this extreme position is not generally taken, it is agreed that the popular ascription of intelligence to these creatures falls wide of the mark.

In the author's view, we have here a confirmation of the theory that consciousness is as old as life. The action consciousness persists, as it were in equilibrium, from the protozoa to the flat-worms. There its path diverges: on the one side lie neural fixity and unconscious response, on the other lie neural plasticity and conscious response. But these alternatives are not absolute; survival requires both fixity and plasticity; the divergence, as we might expect from the common path that precedes it, is a divergence of emphasis, not a complete separation.

Further details — the probable proportion of fixity and plasticity in particular forms, the reason for the extinction of the intermediate types in the vertebrate line — cannot here be discussed. But a word of caution may be added. The lowest organisms that exist to-day have, we must remember, an ancestry that is presumably as long as that of man. They may have remained what, by the theory, they originally were, psychophysical organisms; but they may also have lost the flicker of mind that they at first possessed, and have hardened into unconscious machines. If proof could be brought that all the present protozoa are unconscious, —

the assumption is on all accounts improbable, but we make it for argument's sake, — if this proof could be brought, our theory would still be unshaken ; for the fact would simply mean that, in the course of ages, the protozoa had travelled the whole distance from plasticity to fixity, and had thus lost an original animal characteristic.

§ 126. **The Classification of Action.**— Our discussion of the genesis of action, while it has shown that the instability of the action consciousness is a native and universal character, racial and individual alike, has for that very reason failed to provide us with a typical pattern. We cannot, perhaps, do better than recur to the schematic action of p. 448: the consciousness whose predetermination is represented by the idea of end and the kinaesthesia that means 'You are to move'; which culminates in the apprehension of some object under the influence of the idea of end; and which concludes with the perception of result and the sensations aroused by movement. Such a consciousness, singly determined, and rounding its course from idea of end or result to perception of result, and from anticipatory kinaesthesia to the kinaesthetic accompaniment of movement made, may be termed an impulse.

Impulsive action then degenerates, first, to ideomotor or sensorimotor action, in which the predetermination is unconscious, and the idea or perception of the object at once touches off the movement. Some one says to us, 'There's a caterpillar on your hair!' and we raise our hand and brush the caterpillar away. Or we are talking interestedly and, without interruption of the thought, pass a hand over our hair. Finding a caterpillar there, we may say, 'Ah! I thought I felt something,' and fling it away. From this level the descent continues to the level of the secondary

reflex. The author has evidence that he has made a localising movement, and flicked an insect off his knee, without knowing that he was going to move, that he had moved, that the insect had settled, or that he had removed it.

The impulse may also travel in the opposite direction, towards complication of consciousness. An action may be subject to more than one determination; it may be the expression of a hierarchy of determinations. And it may result from a conflict of impulses, just as secondary attention results from a conflict of primary attentions (p. 272). We then have what is ordinarily termed voluntary action, — though this name is so variously employed that we shall do best to avoid it, and to speak of selective action. This, in its turn, degenerates; first, into ideomotor or sensorimotor action, and then into a reflex. The skilled pianist reads off a musical score at sight; the thought of mail time sends us downstairs with our letters. Or, at the lowest level, our fingers move over the keyboard of the typewriter automatically, while attention is wholly occupied with the matter to be written.

In § 76 we illustrated the development of secondary attention by appeal to an imaginary animal, endowed with two sense-organs. The conflict of impulses may be illustrated, at all its stages, from actual experience. When a young child comes face to face with a strange dog, it behaves as if pulled back and forth by strings; it goes up to the dog, runs back to its father, approaches the dog again, and so on. It has happened to the author, in presence of the two impulses to shut a door on the right and to seat himself at a desk on the left, to begin a right-hand movement towards the door, and then all at once to slue round to the desk, without having closed it. Here we have the conflict of impulses at its nakedest. The case is very different — though the extremes are

connected by a host of intermediate consciousnesses — when the impulses derive from a number of determining and associative tendencies, and when the object is a complex situation. Here psychology is sorely in need of further analyses. We can say, however, from the results of experiments upon the compound reactions, that consciousness need be neither so full nor so logical as the psychologies usually represent it; determinations may be carried in very fragmentary terms, and a wide range of reflective consideration may be packed into a conscious attitude.

The mechanism of selective action is, in principle, understood. It is different with what we may call volitional action, in which an impulse comes into conflict, not with another impulse, but with some associative constellation that has no motor reference. I hear my alarm-clock, and have the impulse to get out of bed; but the impulse is definitely opposed by the idea of another half-hour's sleep. If I get up, I perform a volitional action. What has happened? And what happens if I do not get up?

In the scanty analyses of the cognitive choice reaction that we possess, the reaction in which white was to be reacted upon and other stimuli disregarded (p. 440), the negative instruction came to consciousness either as an 'assurance' that the given stimulus was not to be replied to, or as a felt inhibition of movement, i.e., an unusually strong pressure upon the key from which the finger slipped in the movement of reaction. Experiments upon the associative reaction, in which a negative instruction was given, have recently been reported: pictures were exposed, and the reactor was required to speak the first word that occurred to him, unless it were the name of the object pictured; the name was not to be uttered. Unfortunately, there was no systematic introspection during the fore-period. The mid-period showed various types of consciousness. Thus the name may appear, in internal speech, with a tendency to its utterance; then come the 'thought' that it must not be spoken, and a 'locking' of the throat muscles; and then the fitting association is given. Sometimes the thought alone, sometimes the locking alone, is enough to guide the reaction. Or the thought of the instruction may prevent even the appearance



of the name, after the object has been apprehended. Or, again, the reactor changes the instruction from negative to positive; he observes the details of the picture, asks himself what might be done with the object, and so specialises the association. Finally, we have sheer automatism; the name may appear in internal speech, but it is at once suppressed, without conscious representation of the suppression; or, in extreme cases, the apprehension of the picture touches off directly the appropriate association.

These results are interesting in themselves; they show us some of the conscious aspects of the suppression of one determining tendency by another. They also help us to understand the volitional action. A positive instruction, we may suppose, opens certain nervous channels, but at the same time blocks other channels; it acts not only positively, by facilitation, but also negatively, by inhibition (p. 300). So a negative instruction blocks certain channels, but at the same time opens others; it, too, acts positively as well as negatively. My alarm-clock, then, not only opens the getting-up channels, but interferes with the nervous set — whatever that may be — which keeps me lying still; while the idea of another half-hour's sleep means not only the reinforcement of this nervous set, but also a positive blocking of the suggestion from the clock. The notion of the cortical mechanism as of this double-faced, positive-negative kind does away with the mystery of the conflict in volitional action, though we must add the usual caution, that nothing in detail is known of the subject. —

We remarked in § 103 that words are originally gestures; the word consciousness is therefore an action consciousness. Speech and writing are, in fact, symbolic actions; and they may be selective or volitional, or they may appear in the ideomotor and reflex forms. The signing of my name to a deed is the expression of a highly complex determination; under other circumstances, if I have a pen in my hand and paper before me during a committee meeting, I may write my name again and again, quite unconsciously. The study of gesture in general is a study in the history of symbolic actions; and the symbolism may, at any



moment, reappear ; a particular hand-shake, or the doffing of the hat to a certain acquaintance, may imply reconciliation or social recognition, and may thus be as complex in its determination as the signing of the deed. All this means — what may have been obvious to the reader long ago, and what follows from our insistence upon the fact of determination — that the bodily movement is, in so complicated an organism as man, no index to the action consciousness. To say that 'signing one's name is a voluntary action' is to say what may or may not be true ; it may be a highly elaborate selective action, or it may be a secondary reflex.

There remain the actions which bring into play an inherited mechanism, or express an inherited nervous disposition: the physiological reflexes and the instinctive movements. The former we believe to have had a racial history that parallels the individual history of the secondary reflexes. The latter include a great variety of movements, from complex or serial reflexes up to massive reactions that are accompanied by a highly insistent consciousness. No agreement has so far been reached, as regards either the definition of instinct or its place in the hierarchy of human actions ; but it seems safe to say that the instinctive movement, whatever else it may be, is always initiated by the release of an inherited disposition ; that the instinctive consciousness resembles the impulsive, but is richer in organic components ; and that there is a very close connection between instinctive and emotive reactions.

Instinct has long been one of the catchwords of popular psychology ; even now it stands next only to 'feeling' in looseness of usage and multiplicity of application ; and it does scientific harm, where feeling is innocent, by its profession to explain, to name the cause of action ; animals act 'on instinct,' while man, at any rate in his specially human moods, acts 'by reason.' There

is some excuse for this laxity and confusion, for the phenomena of instinct are of wide range and great complexity. We must, however, ourselves be clear; and we shall achieve clearness most easily by calling to mind the two great branches of the animal kingdom, with their opposed characters of predominating fixity and predominating plasticity. Fixity of response means response by way of an inherited nervous mechanism, purely instinctive response; and it is, in fact, among the insects that we find what are probably the most striking examples of purely instinctive action. Plasticity of response means response by way of an acquired nervous mechanism; and it is in man that we find the most numerous, the most varied and the most complicated examples of non-instinctive action. On the other hand, as we saw no ground for supposing that, in the one line of descent, fixity has entirely replaced plasticity, so we have no ground for denying that, in the other, plasticity is based upon an underlying fixity. Apart from the logical absurdity of an absolute plasticity, we come, again and again, upon evidence that our own determining tendencies are inherited. In so far as this is the case, our actions are instinctive.

As to the existence of an instinctive consciousness, opinions differ. "The idea of consciousness must be rigidly excluded from any definition of instinct;" "any definition of instinctive action that does not insist upon its psychical aspect is misleading;" so the authorities! It is better to appeal to the facts. And the facts show us that actions which proceed from inherited determination (the physiological reflexes excluded) are in this respect like other actions; they show all stages, from full consciousness to complete unconsciousness. There can, however, be no question that the instinctive action, in the middle of its career, is attended by a consciousness of characteristic pattern and of a high degree of complexity.

If we try to work out a rough classification of instincts, we find at the lower end of the scale a number of movements that grade off into the reflex, — such things as coughing, smiling, sneezing, swallowing, threading our way on the street, beating time to

music ; or, in the human infant, such things as sucking, biting, clasping, turning the head aside, standing, creeping, walking, crying, vocalising. These are definite responses to particular stimuli. At the upper end of the scale, we find large, general tendencies : the tendency that makes us take the world of perception as a world of real things ; the empathic tendency that makes us humanise our surroundings, animate and inanimate alike ; the social tendency that makes us imitative and credulous ( ' suggestible ' in a narrower sense : cf. p. 449 ) ; the tendency to dual division, closely connected with the polar opposition of pleasantness-unpleasantness, which makes us classify the world by pairs, good-bad, active-passive, etc. ; the tendency to try things out, which is largely responsible for play, and the tendency to let things be, which is largely responsible for the laziness of a life of routine : — these and other tendencies, which represent total directive pressures laid upon the organism, more strongly upon some individuals and more weakly upon others, but in some measure upon all ; and which are realised or expressed on very various occasions, and with very varying accompaniment of consciousness. Between these extremes lie what we may term the instincts proper : fear, love, jealousy, rivalry, curiosity, pugnacity, repulsion, self-abasement, self-assertion, and so on. No complete list, with verifiable terms, has as yet been made out ; and no adequate analysis of the instinctive consciousness has been undertaken. In general, the consciousness is of the action type ; it differs from the impulsive consciousness in comprising massive complexes of organic sensation ; it changes as the action is repeated, thinning out into sensorimotor forms, or enriching itself by association, according to circumstances ; it passes over, without any sharp line of division, into emotion. On the physiological side, the instinctive reaction is a reaction of the whole organism, not of some organ or member. The determining tendencies which underlie it may be touched off, not only by their proper stimuli, but by other, like stimuli (§ 107) ; they are often transitory, ripening at a definite period of the individual lifetime, and then decaying again ; they are subject to inhibition and reinforcement, both by other determining and by associative tendencies,

N.B.

so that their expression in movement is extremely variable ; and, like the tendencies set up by instruction (p. 449), they are liable to specialisation, to become "systematically organised about certain objects or ideas."

All this must, unfortunately, be left in general terms, though the plan and programme of a psychology of instinct seem clear enough. The term is common to two distinct sciences, psychology and biology ; and the result of this community has been that the psychologists are tempted to write a speculative biology, and the biologists to manufacture a psychology of instinct. The mutual recrimination that has ensued is a doubtful gain to science. What we have to do is to leave biology to formulate its own problem, and to accept its solution of that problem, while we ourselves, as psychologists, describe and explain the instinctive consciousness.

Our classification is herewith complete ; we have made out a family tree for action, and have assigned the various types to their genetic places in it. Let the reader now be warned not to take the classification too seriously ! At the best, classification — whether of perceptions, or of associations, or of actions or of anything else — is not psychology, but only a more or less useful preliminary to psychology. And, in the present instance, we have an unfortunate disjunction of psychological analysis and classification. Analysis has begun, rightly enough, with the reaction experiment ; but the reactions to be analysed have not been shaped in accordance with current classifications of action ; the analysis has rather proceeded, on the old lines, from the simple to the compound reaction, as if the reaction experiment were a thing apart. Our classifications, on the other hand, are the product of a reflective, non-experimental psychology ; we have no introspective guarantee of their adequacy. So we are in this curious position : that we possess a fairly large body of observations of the action consciousness, and

a number of professedly complete classifications of action, and nevertheless are unable to bring the two together. In such circumstances, we shall be wise to accept the observations, and not to commit ourselves positively to any system of classification.

§ 127. **Will.** — The familiar division of mental phenomena into those of intellect, feeling and will is a legacy from the psychology of the eighteenth century. The terms are still in use as class-names: intellect for the experiences based on sensation and image, feeling for the whole of our affective experience (p. 228), and will for the facts of attention and action. Their definition is, however, extremely fluctuating. Thus, imagination is treated, in recent books, under all three headings; and will is sometimes restricted to secondary attention and selective and volitional action, sometimes divorced from attention altogether.

It would, then, be unnecessary to devote a special Section to will, were it not that there is a specific will consciousness. The observers in the reaction experiment report, without hesitation, that their response was or was not willed. The essential factor in this will consciousness appears to be a conscious 'acceptance' of the instruction.

If a foreign stimulus is introduced into a series of muscular reactions, the reactor, who is prepared by the suggestion 'as quickly as possible,' moves in response to it, but is clear that the action was not willed. If a stimulus of the same general kind as the regular stimulus is introduced, *e.g.*, a red in place of a white card, the reactor may be in doubt whether the action was willed or not. In general, any consciousness which is consciously referred to an instruction accepted by the reactor is reported as a will consciousness. Will thus differs, introspectively, on the one hand from the purely associative consciousness, based upon the play of associative tendencies; and, on the other hand, from the

consciousness of command, where there is determination, but not an 'acceptance' of determination. So far as analysis has gone, this acceptance appears as an organic set which carries the meaning 'I agree.' Both terms in the meaning are emphatic; there is a reference to the psychological self, and there is an intention to yield, to acquiesce.<sup>1</sup> It is rarely, however, that the will attitude becomes either explicit or focal. As a rule it is, so to say, incorporated in the total reaction consciousness; the organic sensations which constitute it are blended with the other conscious contents; the reactor does not know that he is willing, but if questioned afterwards declares that he did will. With repetition of the action, and in default of renewed instruction, it disappears altogether.

We shall have more to say of the will attitude when we come to deal with the conscious attitudes in general (pp. 519 f.).

*Conation.*—The *Dictionary of Philosophy and Psychology* writes of conation as follows: "the theoretical active element of consciousness, showing itself in tendencies, impulses, desires and acts of volition. Stated in its most general form, conation is unrest. It exists when and so far as a present state of consciousness tends by its intrinsic nature to develop into something else." These sentences seem to mean that consciousnesses like impulse and desire contain an elementary process of unrest, which cannot be isolated and examined for itself, but the assumption of which is necessary to a full description; and that such consciousnesses, in virtue of the interfused unrest, are themselves restless, actively transitory, and travel of their own accord to their own extinction.

The question of the existence of an active element of unrest can be decided only by appeal to experimental introspection. Wundt, as we have seen, posits an elementary excitement and an elementary tension; but these processes are, for him, affections. The investigators of the reaction consciousness, in all their hundreds

<sup>1</sup> An illustration may, perhaps, be helpful. An observer reports: "Akt der Zustimmung wesentlich motorischer Natur (unmittelbar auf der Ichseite erlebt)": an act of acceptance, of essentially kinaesthetic character, felt as belonging to the self-side of experience. The latter phrase means that the reactor felt himself in the attitude of acceptance, irrespectively of the actual, physical attitude of the body.



of reports, do not discover an active element ; unrest, effort, urgency appear in organic, especially in kinaesthetic terms. The time has gone by for reflective psychologising in the study ; if the champions of the active element wish to be taken seriously, they must either experiment themselves or must propose crucial experiments for others — and must then abide by results. Nothing is easier than to manufacture mental elements (p. 49) ; but the penalty should be six months of introspective labour under laboratory conditions.

The latter part of the definition implies a view of mind that we cannot accept. “Mental activity exists when and so far as process in consciousness is the direct outcome of previous process in consciousness.”<sup>1</sup> If that is the case, the author can only reply that it does not exist at all. The direction of a present consciousness may be predetermined by a suggestion which was itself represented in consciousness ; but to say that the present consciousness is the direct outcome of the foregoing suggestion-consciousness is either to say, simply, that the one immediately follows the other, or is to make consciousness a form of energy (p. 111). And when we read of a ‘tendency’ of consciousness ‘by its intrinsic nature to develop into something else,’ we surely have before us nothing more than a figurative expression drawn from popular biology.

*The Motivation of Action by Affection.* — We referred on p. 263 to the doctrine that pleasantness and unpleasantness are symptomatic of a normal and abnormal mode of life ; and we dismissed it as unproved and irrelevant. This doctrine is often found in connection with another, which gives pleasantness and unpleasantness an active rôle in the mental life ; they are incentives to and deterrents from action, they guide the vital functions, they stimulate the organism’s activity for ends. Pleasantness is thus the sign that we are well ; but it also prompts us to act in such a way that we remain well. Unpleasantness is the sign that we are unwell ; but it also prompts us to refrain from acting in such a way that we become unwell.

There are various ways in which this position may be met. We might question the correlation, as we did before. We might ask

<sup>1</sup> G. F. Stout, *Analytic Psychology*, i., 1896, 148.



how it is that a mental process can incite or deter, 'stamp in' this and 'stamp out' that mode of reaction. All that is necessary, however, is to appeal to the facts. Movement follows on suggestion; and the conscious aspect of suggestion may be pleasurable, unpleasurable or indifferent. Külpe wrote, in 1893, that "the incentives to voluntary activity may be of exceedingly different kinds," so far as they are conscious, and that volition may be "partially determined by unconscious incentives." Thorndike, in 1905, declares that "any mental state whatever may be the antecedent of an intentional act." This position, extreme as it is, squares far better with the introspections of the reaction experiments than does the traditional doctrine of motivation by pleasure-pain.

#### References for Further Reading

§§ 121-127. W. Wundt, *Physiol. Psychol.*, iii., 1903, 242 ff.; *Outlines of Psychol.*, tr. 1907, 203 ff.; W. James, *Princ. of Psychol.*, ii., 1890, 486 ff.

§ 121. E. C. Sanford, *Personal Equation*, in *American Journal of Psychology*, ii., 1888-89, 3, 271, 403. For the history and technique of the reaction experiment. E. B. Titchener, *Exper. Psychol.*, II., i., 1905, 141 ff.; ii., 326 ff., 356 ff.

§ 122. Wundt, *Physiol. Psychol.*, iii., 1903, 410 ff. The analysis follows N. Ach, *Ueber die Willenstätigkeit und das Denken*, 1905; but, so far as these simple reactions are concerned, it has been repeated and verified in the author's laboratory.

§ 123. Wundt, *op. cit.*, 450 ff.; also ii., 1910, 38; Ach, *op. cit.* For the subtractive procedure, Wundt, iii., 450 ff.; Ach, 156 ff.; O. Külpe, *Outlines of Psychol.*, 1909, 410 ff. For the psychology of instruction, Titchener, *Lectures on the Exper. Psychol. of the Thought-processes*, 1909, index under *Problem*. For the diagnostic association experiment, C. G. Jung, *The Association Method*, in *American Journal of Psychology*, xxi., 1910, 219 ff.

§ 124. Külpe, *op. cit.*, [1893] 1909, 409, 415. For determining tendencies, Ach, *op. cit.*, esp. 191 ff.; Titchener, *op. cit.*, index under *Tendencies*. For suggestion, J. M. Baldwin, *Mental Development in the Child and the Race: Methods and Processes*, 1906, 100 ff.

§ 125. Titchener, *Were the Earliest Organic Movements Conscious or Unconscious?* in *Pop. Sci. Monthly*, lx., 1901-2, 458 ff.; cf. *Feel-*

*ing and Attention*, 1908, 387; C. J. Herrick, *The Evolution of Intelligence and its Organs*, in *Science*, N. S. xxxi., 1910, 7 ff.; Baldwin, *op. cit.*, 197 ff., 349 ff.

§ 126. For the negative instruction, H. S. Langfeld, *Suggestion with Negative Instruction*, in *Psychol. Bulletin*, vii., 1910, 200 ff. For instinct, James, as quoted in the text; W. McDougall, *An Introduction to Social Psychology*, 1908.

§ 127. Ach, 230 ff.; A. Messer, *Experimentell-psychologische Untersuchungen über das Denken*, in *Archiv f. d. gesamte Psychol.*, viii., 1906, 203. In support of a conative element, G. T. Ladd, *Psychol Descriptive and Explanatory*, 1894, 211 ff. On motivation, Külpe, *op. cit.*, 445 ff.; E. L. Thorndike, *The Elements of Psychology*, 1905, 282 ff.; D. C. Nadejde, *Die biologische Theorie der Lust und Unlust*, 1908.

## EMOTION

§ 128. **The Nature of Emotion.**—Suppose that you are sitting at your desk, busy in your regular way, and obscurely conscious of a rumble of a car that is passing down the street; and suppose that the rumble is suddenly interrupted by a shrill scream. You leap up, as if the scream were a personal signal that you had been expecting; you dash out of doors, as if your presence on the street were a matter of imperative necessity. As you run, you have fragmentary ideas: 'a child,' perhaps, in internal speech; a visual flash of some previous accident; a scrap of kinaesthesia that carries your whole attitude to the city car-system. But you have, also, a mass of insistent organic sensation: you choke, you draw your breath in gasps, for all the hurry you are in a cold sweat, you have a horrible nausea; and yet, in spite of the intense unpleasantness that floods your consciousness, you have no choice but to go on. In describing the experience, later, you would say that you were horrified by hearing a child scream; the mental processes that we have just named make up the emotion of horror.

An emotion is thus a temporal process, a course of consciousness, and it is also, characteristically, a suddenly initiated consciousness; it begins abruptly, and dies down gradually. It is a highly complex consciousness, since its stimulus is not an object, a perceptive stimulus, but some total situation or predicament. It is through and through an affective consciousness, since both the situation itself

and the organic sensations of the emotive reaction are definitely pleasant or unpleasant. It is an insistent organic consciousness, although the proportion of organic to ideational constituents varies greatly from emotion to emotion and from individual to individual. And, finally, it is always a predetermined consciousness, proceeding in the given case to a natural terminus ; although here, too, there is great variability, since the determining tendencies to which the situation appeals may be almost wholly instinctive, or may be partly instinctive and partly acquired.

We have very elaborate accounts of the 'expression' of emotion, and we have elaborate diagrams, so to speak, of the emotive consciousness ; but, so far as the author is aware, we have no systematic description of emotion, taken under standard conditions. In other words, we have no first-hand analytical psychology of emotion ; and it is this lack that makes the chapter on emotion in the text-books the dreary reading that it is. Two reasons are usually given for the deficiency : first, that it is impossible to bring emotion into the laboratory ; the emotions there set up are artificial, washed-out, insipid affairs ; and secondly that we have no method for the study of emotion, since attention to affection defeats its own object (p. 231). Neither reason is valid. It is not difficult, with a little ingenuity, to arrange situations in the laboratory that shall arouse a fairly wide range of emotions. If these emotions are not of the very intensest, neither are the ordinary emotions of everyday life ; and if they tend to disappear with repetition of the situations, our everyday emotions do the same thing. Besides, the laboratory offers the very great advantage of isolation ; we can get the emotion pure, and without interruption from extraneous processes. On the other hand, it is not necessary to affective introspection that attention be directed upon the affection. Recent work has shown that, if attention is directed upon the stimulus, the situation, an affective judgment comes directly, of itself ; the quality and intensity of the affection touch off the corresponding expression or report. Nothing more

is required than that the observers shall be fittingly instructed, affectively predisposed. When the predisposition to express the feelings has been set up, it is this that is actualised by the presentation of stimulus, and that dictates the introspective report. The observer has no impulse to describe the situation in sensory terms, focal as these terms were. What, now, this predisposition is ; how far (if at all) it interferes with the impression of the stimulus on the sensory side ; with what degree of constancy it may be induced, and how widely it varies from one observer to another : of all these things we are still ignorant. But there can be no question that the mechanism of affective introspection is as it is here described.

The reason, then, that our descriptive psychology of emotion is schematic rather than analytical is, simply, that experimental psychology has so far found neither the time nor the courage to take emotion into the laboratory. But we shall presently have analyses of this, as we are beginning to get analyses of the action consciousness.

*Feeling and Emotion.* — It seems almost self-evident that there is a close connection between the sense-feeling (p. 227) and the emotion, that — to put it roughly — a feeling is a simpler emotion, an emotion a more complex feeling. And the assumption of this connection is justified if, as we explained on p. 408, an emotion may degenerate into a feeling. Nevertheless, certain psychologists draw a sharp line of distinction between the two experiences ; feeling is, for them, a passive and receptive matter, emotion is feeling-attitude, a reaction of the whole conscious organism upon the situation.<sup>1</sup> We can all understand what this distinction means, and we can all think of cases in which it is introspectively attested. But we can also, very certainly, think of intermediate cases, in which the sense-feeling passes into emotion, and the emotion into sense-feeling, without sensible break. The author cannot but think that the majority is in this case right, and that feeling and emotion are species of the same mental genus.

<sup>1</sup> D. Irons, *The Nature of Emotion*, in *Philos. Review*, vi., 1897, 242 ; C. Stumpf, *Ueber Gefühlsempfindungen*, in *Zeits. f. Psychol.*, xlv., 1906, 7 ; G. F. Stout, *A Manual of Psychology*, 1907, 63 f.

§ 129. **The 'James-Lange Theory' of Emotion.** — In 1884, James propounded the rather paradoxical theory that what had ordinarily been regarded as the 'expression' of an emotion is, in reality, the source of emotion as a conscious process. It is worth while to quote the critical passages.

“Our natural way of thinking about the emotions is that the mental perception of some fact excites the mental affection called the emotion, and that this latter state of mind gives rise to the bodily expression. My thesis on the contrary is that *the bodily changes follow directly the PERCEPTION of the exciting fact, and that our feeling of the same changes as they occur IS the emotion.* Common sense says, we lose our fortune, are sorry and weep; we meet a bear, are frightened and run; we are insulted by a rival, are angry and strike. The hypothesis here to be defended says that this order of sequence is incorrect, that the one mental state is not immediately induced by the other, that the bodily manifestations must first be interposed between, and that the more rational statement is that we feel sorry because we cry, angry because we strike, afraid because we tremble, and not that we cry, strike, or tremble, because we are sorry, angry, or fearful, as the case may be.”<sup>1</sup>

No one, James continues, “will be inclined to doubt the fact that *objects do excite bodily changes* by a preorganised mechanism, or the farther fact that *the changes are so indefinitely numerous and subtle that the entire organism may be called a sounding-board*, which every change of consciousness, however slight, may make reverberate. . . . *Every one of the bodily changes, whatsoever it is, is FELT, acutely or obscurely, the moment it occurs.* . . . Each emotion is the resultant of a sum of elements, and . . . the elements are all organic changes, and each of them is the reflex effect of the exciting object.”<sup>2</sup>

<sup>1</sup> W. James, *What is an Emotion?* in *Mind*, O. S. ix., 1884, 189 f. The first sentence of the quotation has been verbally modified. See also *Princ. of Psychol.*, ii., 1890, 449 f.

<sup>2</sup> *Princ. of Psychol.*, ii., 450 ff. James is writing as an advocate, and has — naturally enough — forgotten for the moment the fact of the limen,

Emotion, then, is on this view a group of reflexly excited organic sensations, clustered about a perception. There is no special affective moment in emotion; the whole experience is reducible, psychologically, to reflexly aroused organic sensations.

The theory, which was vigorously and persuasively stated, received a further impetus by the publication, in 1885, of a tract by C. Lange, professor of medicine in Copenhagen. Lange comes independently to a conclusion which, in principle, is the same as that of James, though it is more narrowly formulated. He says:

“It is the vasomotor system that we have to thank for the whole emotional aspect of our mental life, for our joys and sorrows, our hours of happiness and misery. If the objects that affect our senses had not the power to throw this system into action, we should travel through life indifferent and dispassionate; the impressions from the outside world would enrich our experience, would increase our knowledge, but that is all; they would neither rouse us to joy nor goad us to anger, neither bow us in care nor overwhelm us with terror.”

An emotion thus consists, for Lange, of two factors: first, of what he calls the ‘cause,’ a sense-impression which operates, as a rule, by way of a remembrance or an associated idea, and secondly of the ‘effect,’ namely, the reflexly aroused vasomotor changes (changes in the blood supply of the various organs and members of the body) and the changes, mental and bodily, that depend upon them. There is no affective intermediary between these two terms.<sup>1</sup>

which he remembers, *e.g.*, 526 *n.*, 535. No bodily change can be felt (the reader will be on his guard for the differences of terminology between James’ book and the present work) unless it has attained a certain degree of intensity.

<sup>1</sup> The Danish work of 1885, *Om Sindsbevægelse*, was translated into German in 1887 under the title *Ueber Gemüthsbewegungen*: see pp. 47, 50, 76.



*Affection as Reflexly Excited Sensation.* — In § 70 we gave a brief account of some of the ways in which affection is regarded by modern psychologists. The James-Lange theory of emotion suggests yet another view: that the processes which, aroused by the regular channels of adequate stimulation, appear as organic sensations appear, when reflexly aroused, as affections. Münsterberg, in fact, represents this view. “James, Lange and others have taught us to regard the emotions as the mental effects of reflexly excited peripheral processes. . . . We may extend this principle of explanation from emotion to the simple feelings, and may affirm that reflexly excited extensions and flexions are the conditions of the conscious processes that we term pleasantness and unpleasantness.” What appears under the ordinary conditions of stimulation as kinaesthesia or ‘muscular sensation,’ appears under the conditions of reflex arousal as affection.<sup>1</sup>

Münsterberg’s theory of affection thus furnishes an affective basis for the James-Lange theory of emotion; the bodily reverberation of emotion would be affective, and not sensational, because it is set up directly, reflexly, through a preorganised nervous mechanism. It must, however, be added that any such idea of the transforming character of reflex excitation seems to have been foreign to James’ own thought; the nervous processes upon which emotions are conditioned are spoken of by him as ‘sensational’ processes, without qualification. The theory itself has the obscurity of all genetic (as opposed to nativistic) theories; it fails to show us how the physiological fact of reflex excitation can change the mental process correlated with muscular contraction from sensation to affection.

§ 130. **The ‘James-Lange Theory’: Criticism and Modification.** — The theory of emotion outlined in the previous Section has been preëminently successful in ‘getting itself discussed.’ Some psychologists hailed it as the light of a new psychological dispensation; others as vigorously re-

<sup>1</sup> H. Münsterberg, *Beiträge zur experimentellen Psychologie*, iv., 1892, 227; *Grundzüge der Psychologie*, i, 1900, 293.

jected it; yet others, and they the wisest, went critically to work upon it, examining arguments, weighing evidences, considering objections. There can be no doubt that it has exerted a profound influence upon current psychology, though there can, in the author's opinion, be no doubt, either, that its original formulation was one-sided and exaggerated.

An obvious objection, for instance, is that the bodily changes to which James refers may appear identically in very different emotions. There are tears of joy and tears of rage, as well as tears of sorrow; we may strike in fear or in cruelty, as well as in anger; we may run as hard to overtake a friend as we run from the pursuing bear; we may tremble from eagerness or from a maudlin sentimentality, as well as from fright. This objection is fatal, if we take James' earlier statements at their face value. In replying to it and to other criticisms, James has offered a revised version of his theory, whose divergence from the original text is very variously estimated, but which seems to the author to mark a definite retreat from an untenable position. x

There are two principal points to be noted. The first is that James now admits the affective character of the perception which initiates the emotion. He grants a pleasantness or unpleasantness which seems immediately to inhere in the sensible qualities of the perception, which is 'beaten up together [with it] in our consciousness'; and while he finds, in his own case, that this affection is a 'very mild and, so to say, platonic affair,' he writes that "the primary *Gefühlston* [affective tone] may vary enormously in distinctness [or, as we should say, in intensity] in different men." It is not the affective character of emotion, therefore, that

derives from the reflexly excited organic sensations, but rather its specifically emotive character as a general seizure of excitement.<sup>1</sup> Secondly, James explains that the perception which initiates the emotion is not the bare perception of an object, but is the apprehension of a total situation.

“‘Objects’ are certainly the primitive arousers of instinctive reflex movements. But they take their place, as experience goes on, as elements in total ‘situations,’ the other elements of which may prompt to movements of an entirely different sort. As soon as the object has become thus familiar and suggestive, its emotional consequences . . . must start rather from the total situation which it suggests than from its own naked presence.”<sup>2</sup>

The object which starts the emotion is thus a great deal more than a simple stimulus, transformed by a preorganised nervous mechanism into a secondary or reflected afferent discharge; it is a total situation, to which the organism responds along the line of acquired as well as of congenital tendencies.

How far these two acknowledgments, of a primary affection attaching to the perception, and of the situational nature of the perception itself, — how far these admissions alter the theory, the reader must decide. What remain to constitute it are, first, the assignment of an instinctive basis to the emotional reaction, and secondly the insistence on organic sensations as the vehicle of a ‘rank excitement.’

The James-Lange theory undoubtedly owes much of its vogue, among English-speaking psychologists, to the manner of its propounding. The accounts of emotion in the psychological text-

<sup>1</sup> W. James, *The Physical Basis of Emotion*, in *Psychol. Review*, i., 1894, 523 ff. A like ‘primary and immediate pleasure’ is accredited to the subtler (moral, intellectual, aesthetic) emotions in *Princ. of Psychol.*, ii., 468; cf. the article just quoted, 524.

<sup>2</sup> *Ibid.*, 518.

books had become too academic, too conventionalised, and James brought us back to the crude and the raw of actual experience. Nevertheless, it would be quite wrong — as well as being a poor compliment to James and Lange — to suppose that the theory had in it anything absolutely novel. Lange himself points out that his vasomotor hypothesis had been anticipated, in a curiously complete way, by Malebranche.<sup>1</sup> And the emphasis on the organic constituents of emotion is, in reality, as old as systematic psychology. “In reply to the question: What is anger?” Aristotle writes, “the speculative philosopher says it is the desire of retaliation or something of that sort, the naturalist says it is the seething of the pericardial blood or heat. Which of these now, is the real physical philosopher? I answer, it is the man who combines both of these characters.”<sup>2</sup> There are passages in Descartes<sup>3</sup> and Spinoza<sup>4</sup> that look in the same direction. In the first half of the nineteenth century, the anatomist Henle defines emotions as “ideas in connection with the bodily changes that they arouse, changes which manifest themselves in consciousness either as sensations or as dispositions [*Stimmungen*] of the muscular system.”<sup>5</sup> There is a page of Lotze’s *Medicinische Psychologie* that might have been written by James in support of his theory,<sup>6</sup> and Maudsley, in 1867,

<sup>1</sup> *Ueber Gemüthsbewegungen*, 88 ff.; N. Malebranche, *De la recherche de la vérité*, [1674–5] tr. 1694, bk. v., ch. iii.

<sup>2</sup> W. A. Hammond, *Aristotle’s Psychology*, 1902, 8 (the translation has been somewhat condensed); cf. the whole passage, 6 ff., and also 211 f.; H. Siebeck, *Geschichte der Psychologie*, I., ii., 1884, 89 f.

<sup>3</sup> R. Descartes, *Les passions de l’âme*, 1649, arts. 27, 29, 33, 36–38, 46, etc. Cf. D. Irons, *Descartes and Modern Theories of Emotion*, in *Philos. Review*, iv., 1895, 291 ff.

<sup>4</sup> B. de Spinoza, *Opera Posthuma*, 1677; *Ethic*, tr. 1883 and later, pt. iii., def. 3. “By emotion I understand the affections of the body, by which the power of acting of the body itself is increased, diminished, helped or hindered, together with the idea of these affections.” This conception underlies the whole of the analytical treatment of emotion in pt. iii.

<sup>5</sup> F. G. J. Henle, *Handbuch der rationellen Pathologie*, 1846, 257; cf. *Anthropologische Vorträge*, i., 1876, 64 (emotion is “ideation with nerve-sympathies,” that is, with organic sensations).

<sup>6</sup> R. H. Lotze, *Medicinische Psychologie oder Physiologie der Seele*, 1852, 518.

lays stress both upon the organic basis of emotion and upon its relation to instinct.<sup>1</sup> This list of names might, without injustice to James and Lange, be very greatly lengthened, while the psychological parentage of the theory cannot, without injustice to psychology, be entirely passed over. There was no James-Lange theory before James and Lange; but the originality of the theory lies more in its formulation and — if one may so put things — in its timeliness than in its content.

The instinctive nature of the emotive reaction was clearly indicated, in 1880, by Schneider,<sup>2</sup> — who, again, had his predecessors. It has been worked out recently, in systematic form, by McDougall.<sup>3</sup> “Each of the principal instincts conditions some one kind of emotional excitement whose quality is specific or peculiar to it.” McDougall couples in this way the following instincts and emotions (the first member of every pair is the instinct, the second the corresponding emotion): flight and fear, repulsion and disgust, curiosity and wonder, pugnacity and anger, self-abasement and subjection; self-assertion and elation, parental instinct and tender emotion. The principle upon which this list is based, the principle that every emotive situation appeals to preëxisting determining tendencies, is undoubtedly correct; but the list itself is, just as certainly, a matter of individual preference rather than of scientific finality. Anger, *e.g.*, cannot always be referred to pugnacity; tender emotion may be referred to other instincts than the parental. McDougall mentions, further, a number of instincts with less well-defined emotive reaction: the instinct of reproduction, the gregarious instinct, the instincts of acquisition and construction. Yet there are well-marked emotions of sexual love, of security or self-expansion, of possession or self-extension, of success; and if the names of these latter emotions are strange, so are those of subjection and elation, which McDougall admits among the primary emotions. But no

<sup>1</sup> H. Maudsley, *The Physiology [and Pathology] of Mind*, [1867] 1876, 348 ff.

<sup>2</sup> G. H. Schneider, *Der thierische Wille*, 1880, 66, 96, 146, etc.

<sup>3</sup> W. McDougall, *An Introduction to Social Psychology*, 1908, 46 ff.; cf. *Physiological Psychology*, 1905, 108 ff.

classification of this sort can be complete until we have a psychological analysis of the various emotive consciousnesses.

§ 131. **The Organic Reaction as Constitutive of Emotion.** — In the first form of his theory, in which emotion is identified outright with organic sensation, James relied upon two principal arguments. The one is that “if we fancy some strong emotion, and then try to abstract from our consciousness of it all the feelings of its bodily symptoms, we find we have nothing left behind, no ‘mind-stuff’ out of which the emotion can be constituted.” The other is that there are many pathological cases in which emotion is objectless; if, then, we accept the theory, we are able to bring these pathological, unmotivated emotions under a common scheme with the normal emotions. The arguments are, of course, strong or weak in themselves, and not in their relation to any theory; and we must accordingly examine the evidence upon which they rest.

The first argument is logically inconclusive. I cannot, for instance, fancy a sensation that is devoid of intensity; yet the intensity is not identical with the sensation. So the organic sensations might be an integral part of the emotion, and yet not be the emotion. James’ appeal to cases of generalised anaesthesia, in which loss of organic sensation is accompanied by apathy, does not help him; for a complete organic anaesthesia, without impairment of the higher mental processes, is neither known nor, indeed, so far as our present knowledge goes, conceivable.

The second argument depends upon the proof that there are, in fact, wholly unmotivated emotions. And this proof depends, again, in very large measure, upon our definition of emotion and our strenuousness in seeking the motive. James declares that the organic sensations of difficult breathing, fluttering heart, precordial anxiety, crouching posture, etc., make up, in combination, the emotion of morbid fear. But did not this complex, the first few times that it



appeared, arouse what the medical dictionaries call the 'sense of impending death'? And might not this motivated fear leave behind it a predisposition, which later on, when the active fear of death had passed, would throw the organic sensations into the emotive pattern? So with the "absolutely unmotivated fear, anger, melancholy, or conceit" that we see in the asylums: they may be interpreted as the unmotivated descendants of motivated emotions, as due to an emotive predisposition; they yield no evidence that an organic complex is, in itself, an emotion. Normal experience here throws light upon the abnormal. Some contrariety of experience makes us sulky: we know that we are sulky, and know that we are silly, but we go on sulking; not, surely, in the sense that the mere organic sensations of sulkiness persist, but in the further sense that we take everything sulkily, are predisposed to be injured and to brood over the injury.

It may be objected to the two arguments, on the positive side, that a group of organic sensations is, after all, a group of organic sensations; palpitation of the heart is not, in itself, the emotion of dread, and blushing is not, in itself, the emotion of shame. Since, however, this objection can be met by the reference to reflex excitation, it is necessary to scrutinise the organic sensations in more detail. And it then appears that, so far as unaided observation takes us, there is no necessary correspondence between emotion and organic reaction either in intensity or in quality, either in time of appearance or in duration. As regards intensity: there are a quiet joy and a boisterous joy, a cool anger and an explosive anger; the intensity of emotion may be the same, but the organic reaction varies with what we call temperament or mental constitution. The critic, the connoisseur, the scholar, is usually a man of 'quiet enjoyment,' — but there is no evidence that his enjoyment is less than that of the Sunday tripper. As regards quality: the organic reaction of an unexpected joy and a violent anger are, to a considerable extent, the same, while the emotions themselves are widely different. James, it is true, has argued that extremes of emotion not only express themselves in similar ways, but also — as his theory demands — feel alike. In default of any systematic analysis, a state-



ment of this sort leaves us helpless. The author can only say that, in so far as he has been privileged to experience extreme emotions, they have felt very distinguishably different. As regards time : the organic reaction may precede the emotion, as when we are frightened, and shrink back before the feeling of fear arises ; it may outlast the emotion, as when we realise that there is nothing to be frightened about, but the breathlessness and trembling still persist ; and it may come after the emotion, as when sorrow finds vent in tears. All these observations lack precision ; but then so do the arguments against which they are directed.

We conclude that the sensations of the organic reaction cannot be identified with the emotion. They are, it is true, an integral part of the typical emotive consciousness, — but only because the emotion is, essentially, an affective response to a situation which appeals to the organism's instinctive tendencies. Looking at the emotion in this broader light, we can understand the occurrence of its two truncated forms. If an affective predisposition, on the basis of instinctive tendencies, has been set up in the past, then a present group of organic sensations may mean or stand for the complete emotion. And if an emotion has previously run its complete course, inclusive of the organic sensations, then the inhibition or deferment of the organic reaction, later on, does not of necessity destroy the emotion ; the primary feeling, the affectively toned situation, may now, in its turn, mean or stand for the complete emotion. We are in presence of that process of mental reduction which we found to be especially characteristic of the action consciousness (§ 126).

The importance of organic sensations as factors in emotion is shown in many current words and phrases which designate emotive consciousnesses. We are oppressed by care ; we cannot bear certain people ; we are cast down by bad fortune, tickled by a

comic incident, rubbed the wrong way by trifling annoyances, under a great strain of anxiety; we are heart-broken by sorrow, our blood boils in anger, our heart sinks in fear. The heart, indeed, crops up in all sorts of emotive contexts: we do a thing to our heart's content, we eat out our heart, we have our heart in our mouth, we lay a matter to heart, we set our heart on something, we take heart of grace, we wear our heart upon our sleeve. Etymology takes us farther still. We are mortified, that is, bruised or pounded, by some bit of behaviour; we are exasperated, that is, roughened, by a friend's conduct. Anger means a choking or strangling,—a group of organic sensations that we now attribute rather to baffled or impotent anger than to anger itself; fear we have already mentioned (p. 408); grief and sadness both mean heaviness. With reminders like these, it should not be easy for psychology to overlook the organic elements in emotion.

§ 132. **The Organic Reaction as Expressive of Emotion.**— Since the core of every emotion is a feeling, we shall expect to find in emotion all the bodily manifestations of the simple affection; and we find, as a matter of fact, that every emotion brings with it changes in pulse, respiration, volume, involuntary movement and muscular strength. But the situation which arouses emotion is a far more serious matter to the organism than the single stimulus; and the bodily changes set up directly by the change in the nervous system are therefore more intensive and far-reaching. In particular, the organic reaction now extends to the secretory organs. In fear, for instance, the salivary glands cease to act, so that mouth and throat become dry; the body is bathed in a cold sweat; there is a tendency to urination and diarrhoea. In the emotion of impotent rage there is often a derangement of the liver; in grief, an excessive stimulation of the lachrymal glands. Here, then, is a first kind of emotive reaction, which repeats,

in intensified and extended form, the affective reaction of § 71.

Again, the organism has to face the situation by way of a bodily attitude, and the reasons for the special forms of this attitude must be sought from biology. The frightened animal, as we know, crouches down, the angry animal attacks the object of its anger, the startled animal leaps away from the unexpected impression. In the civilised life of man, some of these actions have become unnecessary, and others are partially inhibited by acquired tendencies. Nevertheless, the association of a definite group of organic sensations to the perceived and felt situation still persists. Although we do not crouch down, as if actually to hide ourselves from a stronger opponent, we do shrink into ourselves when we are expecting censure or bad news; although we do not attack when we are angry, we do clench the fist and brace ourselves as if in preparation for attack; and although we do not leap away, we do jump or start when we are surprised. In the wince and brace and start we have survivals of the primitive adjustment by which the organism faced certain typical situations;<sup>1</sup> and our own emotion is not complete until the organic sensations aroused by them have been added to the perception and ideas comprised in the central feeling. Here is a second kind of organic reaction, which has an evolutionary sanction.

When, however, we speak in ordinary conversation of 'expression,' we mean the expression of the face. The facial muscles are arranged about three very important sense-organs, those of vision, smell and taste, and their

<sup>1</sup> Once more, for caution's sake, the reader may be referred to the footnote on p. 408.

adjustment forms part of the total bodily adjustment to the many situations that appeal to those senses. But that is not all. It is a remarkable fact that the facial muscles contribute to the expression of emotions in which they are not directly concerned. Thus, the injured man looks bitter, looks as he would look were an unpleasant morsel placed upon his tongue; the disappointed man looks sour; the wooed maiden looks sweet. Here is a third kind of organic reaction, which is not as readily explicable as that which we have just discussed.

Again, however, there seems to be an evolutionary reason for the expression. Primitive language was essentially concrete and partial, or—as we should now say—metaphorical. And since the one thing necessary, in a primitive society, is food, we may suppose that primitive metaphors would derive, to a large extent, from the preparing and obtaining of food, from cooking and hunting. So the first association to be aroused in a man's mind under pleasant circumstances might very well have been an idea of sweet or palatable food; and the first association, under unpleasant circumstances, an idea of something sour or bitter. Even now we speak of the sweets of love and of revenge, of tainted money, of tasting success, of going on to the bitter end. But whenever a situation brings one of these metaphors to consciousness, the correlated movements of the facial muscles will also be aroused; and when, with the growth of language and the genesis of abstract terms, the metaphor has lapsed, the expressive movements may still persist. In a word, we must suppose that some part-process in the central feeling is connected with the facial reflex by a nerve-path which, originally leading through the associated metaphor, now runs straight from term to term.

The classification, under general principles, of the various forms of emotive expression has been a favourite task with psychologists since Darwin published, in 1872, his work on *The Expression of Emotion in Man and Animals*. Any discussion must be largely hypothetical; and most discussions assume that actions are motived and clinched by pleasantness and unpleasantness. We shall not go into details; the reader who desires to follow the subject will find references on p. 504: but we may take advantage of Darwin's classification to call attention to a common misunderstanding.

Darwin's first principle, of 'serviceable associated habits,' covers the instances given under our second heading. His second principle, of 'antithesis,' is formulated as follows: "Certain states of the mind lead to certain habitual actions, which are of service, as under our first principle. Now when a directly opposite state of mind is induced, there is a strong and involuntary tendency to the performance of movements of a directly opposite nature, although they are of no use; and such movements are in some cases highly expressive." This purely negative principle has received short shrift from critics, although many of them have themselves been guilty of the misunderstanding referred to above. There is a widespread tendency to regard the fundamental animal impulses as of two distinct kinds: the impulse towards, and the impulse away from, the positive and the negative impulse. Yet the adoption of this position leads to nothing but perplexity. It is clear that the distinction cannot be made for man; we run in the same way to escape from a pursuing bull and to catch a train; we dance for joy and for vexation; the movement of approach may signify welcome or rage. But neither can it be made for the lower animals. The animal meets a situation by its most deeply ingrained instinctive reaction; if the reaction is inadequate, it does something else; and if that, too, proves inadequate, it does something else again: this is the procedure that has come to be known, of late years, as the 'method of trial and error.' Should it appear that the creature has but two reactions at its disposal, a seeking and an avoiding reaction, we should have found an extreme case of the stereotyping of instinctive tendencies; but we should be

unwise to generalise from it. The instinctive temptation to classify by pairs is very great (p. 464) ; let us realise that it may also be very misleading.

*The Law of Dynamogenesis.* — We frequently find in psychological text-books a statement to the effect that “every state of consciousness tends to realise itself in an appropriate muscular movement” ;<sup>1</sup> that “every possible feeling produces a movement, and that the movement is a movement of the entire organism, and of each and all its parts”<sup>2</sup> ; that “every change in experience, whether it is initiated by a change in the sensory stimulus or by some internal cause, is accompanied by changes in muscular tension.”<sup>3</sup> The formulations of this law of dynamogenesis, as it is called, are usually sweeping, and do not always tally. In general, however, they carry two implications : that the reflex arc is the unit, the typical unit of function, of the human nervous system ; and that psychology must take account, not only of the afferent process which is correlated with sensation, but also of the efferent process which prompts the organism’s response to stimulation.

There can, now, be no doubt that on the whole, and apart from special theories, modern psychology has tended to one-sidedness in its references to the body ; it has been too easily satisfied with appeal to the organs of sense and to the doctrine of cerebral localisation. This state of things is changing, and changing rapidly. Along with the analysis of the kinaesthetic complexes has come the recognition that consciousness is limited, shaped, directed, modified by physiological factors hitherto overlooked by an explanatory psychology. We are coming, *e.g.*, to speak and think more and more in terms of such concepts as facilitation, inhibition, preparation, sensory and motor attitude or predisposition, cortical set ; and we are beginning to realise that our knowledge of the

<sup>1</sup> J. M. Baldwin, *Handbook of Psychology: Feeling and Will*, 1891, 281 ; *Mental Development in the Child and the Race: Methods and Processes*, 1906, 157. Cf. the ‘law of diffusion’ as stated by A. Bain, *Emotions and Will*, 1880, 4.

<sup>2</sup> W. James, *Principles of Psychology*, ii., 1890, 372.

<sup>3</sup> C. H. Judd, *Psychology*, 1907, 186.



motor mechanisms of the organism must be as exact and detailed as our knowledge of the sensory.

While, however, the author freely grants that, to this extent, the insistence on the efferent nervous process is timely and warranted, he is not convinced that we may speak, in any but a very circumscribed way, of a law of dynamogenesis. Let us write for 'movement' the phrase 'muscular tension,' so that movement includes inhibition; let us extend the meaning of muscular tension to cover glandular activities; and let us leave out of account the fact of the limen. Still it remains doubtful whether every excitation that corresponds to sensation or image tends to a motor conclusion. There may perfectly well be a diffusion within the central nervous system itself, so that the terminus of the excitatory process is a neural rather than a muscular 'tension.' The assumption that the reflex arc is the unit of nerve-function evidently makes the brain nothing more, in principle, than a mass of superposed reflex arcs; the central is assimilated to the peripheral nervous mechanism; the office of the brain is to receive, to couple up, and to send out. But this view, that the nervous system is a system of conduction, a sort of glorified telephone exchange, is in the author's opinion wholly inadequate to explain the phenomena of mind. The theory of conduction, with obstacles or easements between cell and cell, must, he believes, be replaced by a theory of intracellular change, of change within the cell-body; and if this is the case, the cortex may be regarded rather as a disjunction of the reflex arc than as a switchboard for the manifold connection of afferent with efferent process.

Facts are facts; it would be worse than useless to deny the fact of the organic reaction. But speculations are also speculations; and we have no right to generalise the facts, in the interests of a reflex theory, beyond the range of observation. The law of dynamogenesis has a known degree and form of validity; there is no proof that it is a fundamental and universal law of explanatory psychology.

§ 133. **The Forms of Emotion.**—Very many attempts have been made to classify the emotions, to group them



in accordance with some principle that shall show their genesis and relationship. No attempt has been, and no attempt can be, more than partially successful. Emotions are processes of complex structure and of variable course; their analysis is yet in its first beginnings; the names by which we know them are, as a rule, class names, drawn from popular usage, and not terms of any scientific precision. All that can be done at present, therefore, is to indicate one or two of the ways in which classification might be tried, without prospect of any final result.

An emotion appears when a situation or predicament arises. If, then, we could ascertain the typical situations which an organism placed in the world of nature must face, the simplest and most inevitable situations of the physical world, we might perhaps determine the fundamental emotions. It is more probable, however, that we should end with some sort of biological schema of food emotions, chase emotions, sex emotions, and so forth, — a schema that would embody our own reflective interpretation of the situations, rather than a psychological classification of the situations themselves.

All emotions are coloured by the organic sensations set up during the adjustment of the physical organism to the situation. If, then, we could find typical groups of organic sensations — lung, heart, secretory sensations — appearing in the various emotions, we could, again, determine the fundamental forms. So far, however, we have neither physiological nor psychological data for working out a classification upon this basis.<sup>1</sup>

Emotions fall into two great groups according as the

<sup>1</sup> E. Murray, *Organic Sensation*, in *American Journal of Psychology*, xx., 1909, 421.

situations that arouse them are immediately insistent, or reach a climax of emotional appeal only in course of time. Joy and sorrow may be taken as typical of the former group; they are emotions that may be set up, for instance, by the receipt of a telegram. Hope and fear may be taken as typical of the second group; it may be many days before we venture to hope for the recovery of a friend from a serious illness or operation, or before we let ourselves fear that something has happened to the acquaintance from whom no news has come.

We said in § 128 that it was characteristic of an emotion to begin suddenly, and to die down slowly. What, then, of hope and fear? Do they not begin gradually, and die down quickly? It is as the reader chooses; it all depends upon our definition of emotion. To the author it seems best to reserve the term emotion for the domination of consciousness by an affective situation (primary attention); and, from his own observation, he believes that this domination occurs abruptly, — that there is a particular moment at which hope or fear takes possession of the mind, — and that both hope and fear, if left to themselves, pass by slow degrees into indifference. There are, of course, many things to be taken into account: the ambiguity of language, the possible resolution of hope and fear upon disappointment or relief, the recurrence of emotion after a first disappearance. And it should be said that Wundt, who speaks with authority on the matter, distinguishes no less than four modes of the emotive course: the irruptive, which rises quickly and falls slowly; the gradual, which rises slowly and falls relatively quickly; the remittent, which is the normal mode of any persistent emotion; and the oscillatory, which shows an alternation of pleasurable and unpleasurable feeling.

Lastly, emotions fall into two great groups according as they are pleasant or unpleasant. The opposition of affective quality (p. 232) affords a true psychological basis for classification, though it does not carry us very far. It is

responsible for the triads of emotive terms that we find in the dictionaries: joy, composure, sorrow; like, unconcern, dislike; sympathy, apathy, antipathy; attraction, insensibility, repulsion. Experience shows that some men are strongly moved by events that leave others unmoved, and language has accordingly coined terms both for the emotions proper and for the corresponding states of indifference.

It has often been said that language is richer in words for unpleasant than for pleasant emotions; and Wundt has explained this difference on the ground that "the joyous emotions appear to be more uniform, less variously coloured, than the sorrowful." The author is disposed to doubt both statements. Memory is very untrustworthy at the best, as any one may convince himself by trying to inventory, from memory, the contents of a familiar room. And memory is strongly influenced by predisposition; if we try to make out a list of words, with the idea that the tale of unpleasant emotions is the longer, we shall find what we expected. Systematic study of a condensed dictionary, in any of the principal modern languages, reveals a wealth of terms for the pleasurable emotions; and the terms, as they come, have their specific emotive feels upon them.

*Composite Emotions.* — There are, no doubt, composite emotions, as there are composite perceptions; a situation may contain in it the stimuli to two or more emotions, and the concurrence of these stimuli will make itself felt in the resultant consciousness. Some psychologists regard the resultant as a mode of psychical fusion: contempt, *e.g.*, is a binary compound of disgust and elation, scorn a ternary compound of anger, disgust and elation; loathing is a compound of fear and disgust, fascination a compound of loathing and wonder. It seems evident, however, that this analysis is logical and inferential, rather than introspective; the emotions are regarded as fixed experiences, with hard and fast boundary lines; the several stimuli are supposed to arouse each its own definite emotion. The fusion, where it occurs, will surely go deeper down; it will be physiological, a fusion of excita-

tory processes. And we have no reason to suppose that the term 'fusion' covers the ground; there may be inhibition and suppression, oscillation and alternation, as well as mixture. The whole subject still awaits experimental enquiry.

§ 134. **Emotive Memory.** — It is a familiar fact of our everyday experience, and it has been confirmed by experiment, that the memory of past events is, for some persons, accompanied by the affective processes that coloured the events themselves, while for others it is entirely cold and colourless, no matter how intensive the pleasantness or unpleasantness of the original situation may have been. Hence it has been suggested that psychology must recognise, not only the various types of sense-memory (§ 114), but also an affective or emotive memory-type. The French psychologist Ribot, who is the protagonist of this doctrine, sums up his position as follows: <sup>1</sup>

“(1) The emotional memory is *nil* in the majority of people. (2) In others, there is a half intellectual, half emotional memory, *i.e.*, the emotional elements are only revived partially, and with difficulty, by help of the intellectual states associated with them. (3) Others, and these the least numerous, have a true — *i.e.*, complete — emotional memory; the intellectual element being only a means of revival which is rapidly effaced.”

Here, as so often in psychology, there is no dispute about the facts; the question is, how the facts are to be interpreted. In the author's opinion, the two extreme types of observer are distinguished, not by the power or lack of power to image an affection, — for there is no such thing as an affective image, — but by the presence or absence, in memory-complexes, of organic, and more especially of visceral sensations. When a boy is flogged at school, he has, besides the immediate pain of the flogging, all sorts of

<sup>1</sup> T. Ribot, *The Psychology of the Emotions*, tr. 1897, 171.

anticipatory and subsequent stirs of organic sensation, — flutterings, sinkings, chokings, breath-catchings, nauseas. If, when he recalls the flogging in later life, the cortical excitations that underlie his memory-ideas revive the splanchnic and other excitations that constitute the stimuli to organic sensations, then the scene comes back to him with its affective colouring upon it. If, on the other hand, he merely images or symbolises the scene, and the organic sensations are not set up afresh with the process of recall, then the memory is purely 'intellectual,' untinged by emotion. These gross differences undoubtedly exist; but to speak of an emotive memory, and thus to suggest the occurrence of an affective image, is seriously misleading.

It is clear, nevertheless, that on the James-Lange theory of emotion, according to which the organic sensations are blended into a feeling of rank excitement, the phrase 'emotive memory' may be technically correct. In the author's belief, pleasantness and unpleasantness are distinct from sensation; and, as they have not risen to the level of sensory clearness (pp. 260 f.), so they are not paralleled by any purely central process of the imaginal kind. Affection, as the technical term goes, is always 'actual'; it appears always in the same form; it has no substitute or surrogate, as sensation has in the image. If, however, the organic stirs are themselves affective, then — in so far as we admit, from our own point of view, the possibility of an organic image — affective memory is psychologically possible; consciousness would consist of organic images and the recognitive mood. But we have seen (p. 200) that organic images are rare;<sup>1</sup> so that, at least in the great majority of cases, the organic stirs will also be actual; the idea of the flogging will call up, not images of the fluttering and choking, but fluttering and choking sensations; weaker, no doubt, than the originals, but of the same actual sort. Such a reexperience or reinstatement of

<sup>1</sup> An exception should, perhaps, be made for kinaesthesia; most observers report the frequent occurrence of kinaesthetic images. At the same time, these images, too, are commonly blended with weak kinaesthetic sensations.

organic sensation, in sensory and not in imaginal terms, is assumed in the account just given. Only, then, if the James-Lange theory is accepted, and only if the observer is endowed above his fellows with what we should call organic images, only under these circumstances can it be correct to speak of an emotive memory. And since the presence or absence of organic commotion is characteristic, not merely of the memory consciousness, but of all the other intellectual processes as well, it is better to generalise the difference, and to speak of cold and warm temperament, or of emotional and unemotional mental constitution.

*Affective Expansion and Affective Transfer.*—The organic reaction seems, further, to supply an explanation of two phenomena which have been much discussed, but of which we have no thorough-going analysis: the phenomena of affective expansion and affective transfer. The former appears when the pleasantness or unpleasantness of some isolated perception or some single event spreads over the entire situation in which the perception is given, or extends to the subsequent consciousnesses; the latter appears when, *e.g.*, the pleasure that at first attached to something considered as a means becomes transferred to the same thing considered as an end. A casual remark overheard may spoil a whole day's enjoyment; the miser begins to amass his money in order that he may have it to spend, and continues to amass it that he may have it to keep.

What happens, in the first case, is that the remark sets up a complex of unpleasantly toned organic sensations, and that this organic feeling — reinforced by associations, sustained by affective predisposition — persists and recurs until some stronger complex of associative and determining tendencies throws the organism into a new attitude. What happens in the second case is that the pleasurable organic feeling, which at the beginning accompanied the idea of money to spend, is later attached to the idea of money to keep; the organic reaction persists, although the situation is only in part the same. These statements give, of course, only a rough indication of the actual course of consciousness. They show, however, — and this is the important point, — that there is



no affective expansion or affective transfer, in any literal sense; the mechanism of both phenomena is sensory (cf. p. 378).

*Affective Illusions.*—We may speak of an affective illusion in two senses: first, when we are mistaken as to the source of a feeling, and, secondly, when we are mistaken as to the intensity or quality of feeling itself. Illusions of the former kind are liable to occur whenever affective expansion or affective transfer occurs; we may magnify some trifling annoyance into the occasion of our ill-temper, when in reality the ill-temper was there beforehand (expansion); and we may regard the present situation as the originator of a feeling which, in reality, has been carried over from a widely different situation (transfer). These illusions may, as a rule, be easily corrected by retrospection.

Illusions of the second kind are more interesting, and more difficult to explain. You think that you are deeply attached to a friend; he goes to another part of the world, and you find that his absence is a matter of entire indifference. You think that you have no particular liking for so-and-so; he goes away, and you miss him dreadfully. You are looking forward eagerly to a certain event; circumstances prevent your taking part in it, and you are surprised to discover that you are relieved. You are oppressed and gloomy in the anticipation of another event; circumstances hold you off from that, and you are surprised at your disappointment. How are these things to be accounted for? We can only guess. For one thing, we must suppose that the situation as imagined rarely tallies exactly with the situation as presented; and we must remember that there is no possibility of their direct comparison; we have to wait the event. For another thing, we all have a tendency to overestimate the stability of our affective life. This tendency may very possibly be instinctive; though the universal actuality of affection (p. 494) may also contribute to a lack of perspective in matters of feeling. At all events, we overlook the fact of affective adaptation (p. 229). Yet, again, we must bear in mind that we are suggestible: heterosuggestion and autosuggestion alike, playing upon some temporary attitude, may arouse a feeling that is foreign to our more customary, more permanent disposition.



But, when all is said, we have to confess that the affective illusions point to unsuspected depths and shallownesses of impression, and to unsuspected powers of the unconscious tendencies.

§ 135. **Mood, Passion and Temperament.** — The weaker emotive consciousnesses, which persist for some time together, are termed moods; the stronger, which exhaust the organism in a comparatively short time, are called passions. Thus, the mood of cheerfulness represents the emotion of joy; the mood of depression, that of sorrow. On the other hand, rage or fury is a passion, anger an emotion; and we speak of a passionate grief, a passionate love, a passion of terror, when we wish to indicate a high degree of emotive intensity. However, no sharp line of distinction, either intensive or temporal, can be drawn between these various processes.

The name of passion is also given to any abiding interest, to any mode of strong emotive response that is specific and lasting. We say that a man has a passion for success, for science, for gambling; and we mean that a situation which shows any sort of reference to these things will appeal to him, dominatingly and one-sidedly, through that reference.

In its ordinary course, the mood rises slowly to a maximum and then slowly dies down. Something upsets you, makes you irritable; you proceed to take everything irritably, and so become more irritable still; after a while, the incidents that prompt to irritation seems to grow rarer, and the irritability gradually disappears. There are times, however, when some intercurrent event brings about a quick and total change of mood. And there are times when the mood passes abruptly, without assignable reason; you are surprised to find yourself suddenly cheerful. All this points definitely to the importance of organic excitation, and in so far bears out the hypothesis of § 74.

Popular psychology classifies mental phenomena under the headings of intellect, feeling and will (§127), and individual endowment under the corresponding headings of talent or ability, temperament and character. Temperament, so far as it can be employed in a strictly psychological sense, is thus a very general term for affective constitution, for the congenital susceptibility of the individual to emotive stimuli and for the typical character of his emotive response. Talent, in the same way, denotes intellectual constitution, and character active constitution.

The doctrine of temperaments was first systematised by the Greek physician Galen, though the germs of the popular fourfold classification go back much farther in the history of thought.<sup>1</sup> This classification takes account of two moments: the strength and the duration of emotive response. We thus get the following table:

	<i>Strong</i>	<i>Weak</i>
<i>Quick</i>	Choleric	Sanguine
<i>Slow</i>	Melancholic	Phlegmatic

The choleric temperament is impulsive, easily roused to strong emotion, but as easily diverted from the emotive situation; and so on. Literature furnishes us with typical instances. Thus, Hamlet and Laertes are respectively melancholic and choleric; Falstaff and the younger Percy, in the first part of *King Henry IV.*, are respectively sanguine and choleric; while the scenes between Touchstone and Audrey in *As You Like It* bring the sanguine and phlegmatic temperaments into sharp contrast.

Several more elaborate classifications of temperament have been published in recent years. They are, however, of interest rather for an applied than for a general psychology.

§ 136. **The Nature of Sentiment.** — We have distinguished remembrance from recollection, reproductive from con-

<sup>1</sup> Claudius Galenus, A.D. 131 to 210. See H. Siebeck, *Geschichte der Psychologie*, I., ii., 1884, 278 ff.

structive imagination, according as the memory and imaginative consciousnesses show the pattern of primary or of secondary attention (pp. 275 f.). We may now draw a like distinction between emotion and sentiment. In emotion, the organism faces a situation in the attitude of primary attention; the situation overwhelms it, takes undisputed possession of consciousness. In sentiment, the situation to be faced is more complex; its appeal to attention is both multiple and conflicting; it suggests hesitation and deliberation, and evokes the critical attitude. The sentiment, as thus defined, represents the last stage of mental development on the affective side, as thought represents the highest level of development on the side of sensation and image.

Secondary attention lapses, as we saw, into derived primary attention. Hence it is natural that the sentiment, which is developed out of emotion, and is characteristic of a higher stage of mental differentiation, should readily slip back into emotion. Suppose, *e.g.*, that I sit down to read a story. At first, I have various aesthetic sentiments; I linger over the beauty of the style, or the harmony of the incidents. I have, too, various intellectual sentiments; I feel that the tale is true to life, that its scenes are self-consistent. But, as I read, I grow absorbed; I cease to be critical, to be secondarily attentive; the story takes possession of me, and the writer moves me as he will. Sentiment has now been replaced by its simpler counterpart, emotion.

Not only, however, is it true that sentiment tends to lapse into emotion; many of us never experience sentiments at all. My 'sentiment' of honour, *e.g.*, may never have cost me a moment's effort of attention. A definition of honourable conduct has come down to me, by tradition, and is exemplified by the behaviour of those about me, and I accept it without thought. All through my life, if this is the case, conduct-situations will take possession of me; I shall face them simply by an emotion.

Sentiment about 7. is highly emotional,

*The Definition of Sentiment.*—The author must confess that the meaning here given to the term ‘sentiment’ is largely arbitrary. But, to quote another psychologist, “this word is very loosely used in ordinary language, and psychologists in general have failed to give it a meaning much more precise. There can therefore be no harm in applying it as we propose.” Other current usage identifies sentiment with what we have called passion (in the second sense), *i.e.*, with such things as love of power, of fame, of economy, of cleanliness; hatred of injustice, of oppression, of affectation; devotion to science, or art, or religion. It seems, however, more natural to speak of a passion for cleanliness, a passion for order, a passion for justice, a passion for old furniture, than to name these affective dispositions ‘sentiments.’

§ 137. **The Forms of Sentiment.**—There are four great classes of sentiments: the intellectual or logical, the ethical or social, the aesthetic and the religious. Modern psychology has devoted more attention to the aesthetic sentiments than to the other three groups,—partly, no doubt, because they can be examined under experimental conditions and with comparatively simple materials.

*Experimental Aesthetics.*—The history of experimental aesthetics, which begins with G. T. Fechner in the year 1871, repeats in little the history of experimental psychology. Investigators were at first concerned to discover the nature of the beautiful object, and to express this nature in quantitative terms (cf. p. 430). It was found, *e.g.*, that simple visual figures are most pleasing either when they are divided symmetrically, in the proportion 1:1, or when they are divided at a point so chosen that the dimensions of the whole are to those of the larger part as the dimensions of the larger part are to those of the smaller (the golden section; approximately 3:5). It was found that curved lines are, on the whole, more pleasing than straight lines, and that the meeting of two straight lines in a right angle is particularly displeasing. It was found, again, that binary colour combinations are most pleasing when the colours chosen are either neighbouring or approximately

complementary, and so on. And attempts were made to explain these results in detail. Thus, the human figure is symmetrically built: hand repeats hand, and foot foot. Moreover, waist repeats neck, abdomen repeats chest, legs repeat arms. The proportions of the body, measured from the navel as centre, are approximately those of the golden section. Moreover, the upper part is divided at the neck, and the lower at the knees, roughly in the same ratio, 3 : 5. Ease of eye-movement was held responsible for the pleasingness of curved lines; the eyes feel the jerk involved in any abrupt change of linear direction. The appreciation of colour schemes was referred to contrast, or to ease of transition, or even to the existence of characteristic colour patterns in animals lower in the scale of organic development. The pleasures of rhythm and of tonal consonance were standardised and explained in a similar way.

In all this work, there is but scanty appeal to introspection. Choices are made, preferences indicated, and the statistical results are then reduced to averages, which take rank as scientific constants. Gradually, however, the belief grew that an introspective description of the aesthetic consciousness is the *sine qua non* of a psychological aesthetics. And attention is now directed to an analysis of the aesthetic attitude and its motives, to the laws of attentive apprehension and of empathy, to the successive stages of aesthetic reaction, to individual differences of aesthetic appreciation. Experiments have been made upon colours, singly and in combination; upon spatial forms and arrangements; upon rhythms; upon musical cadences and the principal modes of musical composition; upon reproductions of well-known paintings and of the chief architectural types; upon the 'funny pictures' of the magazines. It is too early to generalise; indeed, experimental aesthetics has by no means received the general recognition accorded to-day to experimental psychology; there are many students of aesthetics who will have none of it. We may say, however, that the doctrine of empathy, the doctrine that all aesthetic effect depends upon the reading of our own activities into the world about us (p. 417), is as characteristic of the present as the doctrine of the golden section was of the earlier period of the science.

Stimuli that arouse the sentiments of beauty, of ugliness, and of comedy may be brought into the laboratory; hardly stimuli that call out the sentiments of sublimity and tragedy. Here is one grave difficulty in the path of an experimental aesthetics. Another, and perhaps a still more serious difficulty, lies in the fact that the aesthetic tends to lapse into the merely emotive attitude, and this again to pass by affective adaptation into indifference. How shall we be sure that the observer, in an aesthetic experiment, gives a truly aesthetic reaction? The only course is to accumulate a very large number of observations, and to let the aesthetic *differentia* emerge of itself (pp. 32 f.). In the meantime, to accept any of the historical theories of aesthetic sentiment — as that whenever we enjoy the ludicrous we are consciously realising our own superiority (the theory of degradation); or that the feeling of the ludicrous arises from the nullification of a process of expectation (the theory of incongruity)—would be entirely premature.

*Intellectual Sentiments.*—The nature of these sentiments is a matter of inference rather than of observation. We should probably all grant, from casual observation, that there are true sentiments of agreement and contradiction, of ease and difficulty, of truth and falsehood, of belief and disbelief. When, however, the attempt is made to bring them into the laboratory, by the method to be described in § 139, we find mainly degenerate forms, like the secondary feelings of recognition and imagination; we get affective attitudes rather than sentiments. Our observers have the work of secondary attention behind them, and it is not easy to place them in a situation in which an intellectual sentiment is aroused. On the other hand, the method employed is extremely recent, and was primarily devised for the study of thought itself. Hence it is possible that a modified method, employed with the direct intention of evoking sentiments, might be more successful.

*The Social or Ethical and the Religious Sentiments.*—Among the social sentiments we may place such experiences as shame and pride, humiliation and vanity, guilt and innocence, freedom and restraint, trust and distrust, gratitude and ingratitude, envy and compassion, jealousy and magnanimity, emulation and self-efface-



ment, indebtedness and patronage, forgiveness and revenge ; among the religious, such experiences as awe, reverence, humility, unworthiness, faith, resignation, exaltation, remorse. Very few of these sentiments, however, are realised ; most of them appear, at the best, as emotions, and ordinarily as secondary feelings or affective attitudes. No experimental study has been made of them.

*The Expression of Sentiment.* — So far as our data go, the organic reaction in sentiment is of the same kind, but of less intensity, than it is in emotion. The reason is that the primary feeling, the affectively toned situation, has in most cases come to mean or stand for the total experience (p. 483). Casual observation would seem to show that in the complete realisation of a sentiment — when, *e.g.*, one feels for the first time that one has a critical judgment in some department of intellectual work ; when, after the laborious study of art-canon and the repeated dissection of art-forms, one feels oneself in some measure adequate to the masterpiece under contemplation — observation seems to show that, in such cases, the organic reaction is fully as widespread and as intensive as it is in the case of joy or anger. The witness of language is here of small value, since the name of any sentiment may also designate an emotion.

#### References for Further Reading

§§ 128–137. W. Wundt, *Physiol. Psychologie*, iii., 1903, 209 ff. ; *Outlines of Psychol.*, tr. 1907, 188 ff. ; T. Ribot, *The Psychology of the Emotions*, tr. 1897 ; A. Lehmann, *Die Hauptgesetze des menschlichen Gefühlslebens*, 1892 ; A. Bain, *The Emotions and the Will*, [1859] 1880.

§ 128. W. Wundt, *Zur Lehre von den Gemüthsbewegungen*, in *Philosophische Studien*, vi., 1891, 335 ff. ; C. Stumpf, *Ueber den Begriff der Gemüthsbewegung*, in *Zeits. f. Psychol. u. Physiol. d. Sinnesorgane*, xxi, 1899, 47 ff.

§ 129. C. Lange, *Ueber Gemüthsbewegungen*, 1887 ; W. James, *Princ. of Psychol.*, ii., 1890, 442 ff.

§§ 130, 131. W. James, *The Physical Basis of Emotion*, in *Psychol. Review*, i., 1894, 516 ff. ; H. N. Gardiner, *Recent Discussion of Emotion*,



in *Philos. Review*, v., 1896, 102 ff.; Stumpf, *op. cit.*; J. Ward, art. *Psychology*, in *Encyc. Brit.*, xxxii. (viii. of 10th ed.), 1902, 65.

§ 132. On the laws of emotive expression, C. Darwin, *The Expression of Emotion in Man and Animals*, [1872] 1890, 28 ff.; Wundt, *Physiol. Psychol.*, iii., 1903, 284 ff.; James, *Princ. of Psych.*, ii., 1890, 477 ff.; B. Bourdon, *L'expression des émotions et des tendances dans le langage*, 1892, 19 ff.; J. M. Baldwin, *Mental Development in the Child and the Race: Methods and Processes*, 1906, 211 ff.; E. Cuyet, *La mimique*, 1902. Further references on dynamogenesis in the author's *Experimental Psychology*, II., ii., 1905, 364 ff.

§ 133. Wundt, *op. cit.*, 225; James, *op. cit.*, 485; D. Irons, *The Primary Emotions*, in *Philos. Review*, vi. 1897, 626 ff.; W. McDougall, *An Introduction to Social Psychology*, 1908, 45 ff.

§ 134. T. Ribot, *op. cit.*, 140 ff. On expansion and transfer, A. Lehmann, *op. cit.*, 266 ff.; E. Freiherr von Gebssattel, *Bemerkungen zur Psychologie der Gefühlsirradiation*, in *Arch. f. d. ges. Psychol.*, x., 1907, 134 ff. On illusion, T. Ribot, *Problèmes de psychologie affective*, 1910, 147 ff.

§ 135. Stumpf, *op. cit.*; T. Ribot, *Qu'est-ce qu'une passion?* in *Revue philos.*, lxi., 1906, 472 ff.; *Comment les passions finissent*, *ibid.*, 619 ff. On temperament, Ribot, *Psychology of Emotions*, 380 ff.; F. Paulhan, *Les caractères*, 1894; A. Fouillée, *Tempérament et caractère selon les individus, les sexes, et les races*, 1895. ✕

§§ 136, 137. Wundt, *op. cit.*, 123 ff., 624 ff.; Ribot, *op. cit.*, 260 ff. On experimental aesthetics, G. T. Fechner, *Zur experimentalen Aesthetik*, 1871; *Vorschule der Aesthetik*, 1876; J. L. des Bancels, *Les méthodes de l'esthétique expérimentale; formes et couleurs*, in *Année psychologique*, vi., 1900, 144 ff.; O. Külpe, *Gegenwärtiger Stand der experimentellen Aesthetik*, in *Bericht über den II. Kongress f. exper. Psychol.*, 1907, 1 ff.

## THOUGHT

§ 138. **The Nature of Conscious Attitude.** — Experimental psychology, all through its history, has drawn great profit from incidental results. At a time when critics were declaring that the experimental method could never take us beyond the senses and the measurement of durations, at this very time the work done in sensation and reaction was throwing new light upon attention and recognition, comparison and discrimination. Every study that was undertaken, however narrowly conceived, bristled with suggestions for further study; and the reader of to-day wonders alike at critic and at investigator, — at the critic for his blindness, at the investigator for the tenacity with which he held, among a hundred distracting discoveries, to the single purpose of his investigation.

Since the beginning of the twentieth century, the centre of interest for experimental psychology has lain in the field of thought. And an incidental result of the attempt to analyse the processes of thought was the discovery of the conscious attitudes. What precisely these attitudes are, in their psychological status, is still a matter of dispute. They are reported as vague and elusive processes, which carry as if in a nutshell the entire meaning of a situation. They have now a predominantly emotive and now a predominantly intellectual character. They are indicated, designated, either by a single word, such as 'hesitation,' 'vacillation,' 'incapacity,' or by a phrase, such as 'a realisation

that the division can be carried out without a remainder,' 'a remembrance that we talked it all over before and couldn't reach any conclusion.' If the reader will now try to induce one of these consciousnesses in himself, — the consciousness of general helplessness in trying to understand a complicated argument, or the consciousness that 27 will go evenly into 243, — he will realise the nature of the conscious attitude, the disproportion of logical meaning to psychological content, and the consequent difficulty of analysis.

It is impossible to give a list of the conscious attitudes; first, because the meaning of terms is not fixed, — words like doubt, hesitation, uncertainty, are often used interchangeably; but secondly, and more importantly, because there seems to be no complex mental experience that may not appear in attitudinal form. We may have, under the guise of attitude, the consciousness that something is real, that it is lasting a long time, that it is over more quickly than we had expected, that it is the same as what came before, that it is incompatible with some other thing, that it makes sense, that it is novel, that it is on the tip of the tongue, that it will be difficult, that we need not do it, that we are not ready for it, that we can do it if we try, that we have made a mess of it, and so on. Or, on the emotive side, we may feel that we approve, that we dissent, that we are saved, that we have been tricked, that the whole thing is trivial, that at all events we have done our share, that we should like to swear, that it is rather interesting after all, that no one has the right to treat us like this, that we may as well go through with it, and so on again. There seems literally to be no end, till we have exhausted the resources of the language, to the catalogue of possible attitudes.

When the conscious attitudes first appeared, in the introspective reports of laboratory observers, they were set down as unanalysed; and the implication was that, while under the circumstances they resisted analysis, and must

just be named and dismissed, they might, under more favourable conditions, be resolved into the familiar elementary processes, — into sensation, image and affection. But the main interest of later investigations has been the mechanism of thought, of judgment and reasoning; the attitudes have not been studied for their own sakes; and so, in default of special analysis and in view of the ever lengthening list of discriminable consciousnesses, the impression has grown up that they are unanalysable. Some psychologists maintain, definitely, that there are awarenesses of meaning, and awarenesses of relation, which cannot be reduced to simpler terms, but must be accepted as non-sensory and imageless components of the higher mental processes. The author believes, on the contrary, that the attitudes, so far as they are conscious at all, are always analysable.

The reader should clearly grasp the experimental situation. In the case of emotion, we have practically no introspective data; aside from a few observations taken in the course of work by the method of expression (p. 243), there is nothing but physiology and the schematic psychology of the text-books. In the case of the attitudes, we have a great bulk of recorded introspections; but the main emphasis has been placed, almost without exception, upon something else than attitude. The observers, being honest and competent, have noted the attitudes as they passed, — and that is all. Very little attempt has been made to bring an attitude to the conscious focus, or to trace its genesis and decay. It is an advantage, truly, that consciousnesses like doubt, hesitation, trying to remember, feeling sure, have been recognised for the puzzling things they are, set forth as problems for analytical treatment: only, a very serious and detailed effort at analysis must be made, before they can be classed as elemental and unanalysable.

The psychological situation with regard to attitude is, in fact, very much the same as it is with regard to affection (pp. 256 f.).

The doctrine that our affective life shows degrees of pleasantness-unpleasantness, and nothing more, seems a little derogatory, as well as unjust to the complexity of human experience ; and so there is a general readiness to accept any suggestion of other affective dimensions that squares with everyday observation. In the same way, the doctrine that our intellectual life is, in the last resort, a matter of sensations and images, — this too seems derogatory and unjust, and any evidence that tells against it is welcomed. The author has no wish to insinuate that either of these issues is closed ; so long as psychologists of standing disagree, so long are the issues very positively open. He does desire to warn the reader against a natural bias, that may lead to a prejudging of the questions before they have been settled by experiment.

If, now, there are non-sensory and non-imaginal components of the higher mental processes, we have before us three distinct possibilities. There may be an independent element of thought, coordinate with sensation. This position has recently been taken, but in the present state of psychology it is indefensible (§ 139). There may, again, be a dependent element of thought, an elementary process which, like affection (p. 234), cannot stand alone in consciousness, but is nevertheless irreducible to image. We consider this question in § 140. And there may, thirdly, be a specific form of combination (§ 104), a thought character which is common to all thinking, and without which no complex of images can become a thought. In this case thought would still be an element, but an element, so to say, of a higher order than sensation, image and affection. We consider the question in § 141.

§ 139. **The Alleged Elementary Process of Thought.**— A descriptive psychology of thought will tell us, in analytical terms, what we experience when we are thinking. And if the description is to be adequate, the thinking from which it is derived must go on under laboratory conditions. We must make our observers think, really and seriously think ; and we must be able to make them think again and again, to vary the circumstances and the modes of their thinking,

and to rule out disturbing influences. How is this to be done ?

It has not yet been satisfactorily done. But a first attempt has been made, by way of a greatly modified form of the reaction experiment. The experimenter reads to the observer an epigram, or an aphorism, or a didactic couplet, or puts to him some question suited to his temper and attainments. The question is always answerable by Yes or No, and the epigram is thrown into interrogative form by a preliminary : Is this true ? Do you understand this ? A stop-watch is started as the stimulus is given, and is arrested as the observer replies ; the time that elapses is a rough indication of the difficulty of the problem. When the answer has been returned, the observer undertakes to describe, as accurately as possible, his experiences during the experiment. A single instance must suffice.

“ Is this true ? ‘ To give every man his due were to will justice and to achieve chaos.’ — Yes. — First of all, a peculiar stage of reflection, with fixation of a surface in front of me. Echo of the words, with special emphasis on the beginning and end of the sentence. Tendency to accept the statement. Then, all of a sudden, Spencer’s criticism of altruism occurred to me, with the thought that Spencer mainly emphasises, — the thought that the end of altruism is not attained. Then I said, Yes. No ideas, except the word Spencer, which I said over to myself.”

It is clear that a procedure of this kind, if worked out with skill and understanding, will come within measurable distance of our definition of an experimental method (p. 20). But its defects are also apparent. In the instance given, we find significant fragments of internal speech, the echo of the stimulus and the single word ‘ Spencer.’ We find as well, however, the report of a peculiar stage of

reflection, and of a tendency to agreement. Unless we can introduce stimuli, later on in the experiment, that shall give the observer a chance to examine the reflection and the conscious tendency, we run the risk of passing, as unanalysable, experiences that might, if they were made focal, prove to be complex.

So far, this inherent defect of the method has not been remedied. The introspective reports have simply been collated, and the processes which they mention classified, under general headings, as ideas, feelings, attitudes, and processes that are termed sometimes awareness, sometimes knowledge, sometimes 'the consciousness that . . .,' most frequently thoughts. The inference has therefore been drawn that knowledge, awareness, is a new manifold of modifications of consciousness, covering the variety of thoughts as sensation covers the variety of sensations; and that thoughts may appear in consciousness without any the least demonstrable trace of imaginal groundwork. There is a thought element.

Surely a large inference upon a slender basis of fact! Taking the situation as it stands, we have every right to demand a suspense of judgment. For it cannot be too often repeated that no one is justified in declaring a process unanalysable unless he has failed to analyse it under the conditions most favourable to analysis; and these conditions the method, as so far employed, does not supply. As a matter of fact, however, we can go further. A subsequent report by one of the observers, himself a trained psychologist, relieves us from suspense of judgment. He writes as follows:

"I have followed the course of the investigation, in which I was privileged to take part as observer, with keen interest. And I



have been led to a rather curious result, which has altogether changed my ideas of the best method for the conduct of experiments on thought. Over and over again, as I was observing, I had the impression, though I was not able at the time to formulate it very clearly, that my report was simply a somewhat modified verbal statement of the thoughts aroused in me by the experimenter, and that this verbal statement could not properly be regarded as a psychological description of the thoughts. What I mean by this antithesis, of verbal expression and psychological description, will perhaps become clearer if I suggest that the layman in psychology would be giving introspective reports, every time that he exchanged thoughts with a friend, unless there were some distinction between verbal expression and psychological description."

The nature of this distinction is plain enough. What we do, when we exchange ideas in ordinary conversation, is to indicate the object of the ideas, to show what we are thinking about; we refer, and are understood to refer, to the weather, or to politics, or to the cost of living; we have not the least desire or occasion to go behind the topic of thought to the psychological vehicle of that topic, to discover whether our friend is thinking in internal speech, or in visual images, or in conscious attitudes. But this question, of the mental stuff of which thought is made, is precisely the question that a descriptive psychology of thought has to answer.

So, then, the observers in the investigation that we are reviewing took the only course open to them. They were in honour bound to mention any process that appeared. Thoughts appeared, and were mentioned; but they came and passed far too quickly for thorough scrutiny, and were accordingly noted as 'thoughts of' and 'consciousnesses that.' Not only is there no proof that these thoughts were elemental; there is positive evidence that they were not.

§ 140. **The Alleged Elementary Process of Relation.** — In a well-known passage of his *Psychology*, James urges that “we ought to say a feeling of *and*, a feeling of *if*, a feeling of *but*, and a feeling of *by*, quite as readily as we say a feeling of *blue* or a feeling of *cold*.”<sup>1</sup> In response to this suggestion, an attempt has recently been made to bring the relational consciousness under experimental control. The experiments took the form of problems in the ‘rule of three,’ extended to other than numerical relations. Most important for our present purpose, on account of the accompanying introspections, are those in which the stimuli were presented in verbal form. The observer was asked, for instance, ‘London is to England as Paris is to —?’ or: ‘Eyes are to face as a lake is to —?’ He was required to answer these questions, in the sense of the relation obtaining between the first pair of terms, and then, afterwards, to give an introspective account of the whole experience. The results were of three kinds. The blank may be filled up, under pressure of the instruction, without any consciousness of relation; the transferred relation may be carried in visual images, or in internal speech; and, lastly, the relation may be present in consciousness, without any imaginal component, simply as an ‘imageless thought.’ From these results the conclusion is drawn that “the feelings of relation are of the same order as feelings of sensory qualities; each feeling of relation is a simple quality.”<sup>2</sup>

The experiments have been repeated and extended, in the author’s laboratory, with a different outcome. By far

<sup>1</sup> W. James, *Princ. of Psychol.*, i., 1890. 245 f. The word ‘feeling,’ as we have previously noted, here means any mental process.

<sup>2</sup> R. S. Woodworth, *The Consciousness of Relation*, in *Essays Philosophical and Psychological in Honour of William James*, by his colleagues at Columbia University, 1908, 491, 499.

the larger part of the answers were accompanied by a consciousness of relation in terms of sensory or verbal images. The remainder were cases of verbal association, directed by the instruction; the fourth member of the group was supplied as if automatically, inevitably, without any consciousness of relation. There is no trace in the reports of an imageless 'feeling of relation.' As these experiments are more numerous and more varied than those quoted in support of the relational element, the author feels justified in saying that the negative outweighs the positive evidence.

The experiments just referred to do not stand alone. It has been shown that the meaning of prepositions, taken out of all context and presented by themselves, is carried by "a certain tension or motor impulse, which has no purpose, significance, affective tone, nor feeling of will or agency." With the word *in*, e.g., "there seems to be a bare huddle, without any purpose in view"; "I am vaguely conscious of crouching in regard to something, although I have no idea of what." The same thing holds of *out*, *with*, *of*, etc.; every word has its characteristic kinaesthetic set.<sup>1</sup> Here are James' feelings of relation, shown in isolation and at full strength; but they turn out to be kinaesthetic complexes, and not elementary processes.

As regards genesis, it has been suggested that our human feelings of relation "are remnants of remotely ancestral motor attitudes. Take the 'feeling of but,' for example: the sense of the contradiction between two ideas. If we trace this back, what can it have been originally but the experience of primitive organisms called upon by simultaneous stimuli to make two incompatible reactions at once, and what can that experience have been but a certain suspended, baffled motor attitude? Similarly with the 'feeling of if'; the primitive representative of this must have been the experience of an animal called upon to suspend all

<sup>1</sup> E. H. Rowland, *The Psychological Experiences connected with the Different Parts of Speech*, 1907, 24 ff. (*Psychol. Review*, Mon. Suppl., 32).

reaction until a definite added stimulus was given.”<sup>1</sup> If we accept this account as, in principle, correct, then the apparent simplicity of a feeling of relation would be a vestigial, not a primal simplicity,—a matter of reduction and degeneration, and not of elementariness.

In the author's experience, the feelings of relation are never simple. They are ordinarily matters of motor empathy; the relation is acted out, though in imaginal rather than in sensory terms. Sometimes the kinaesthetic images are accompanied by a visual image, itself usually symbolic; sometimes they are strongly coloured by pleasantness-unpleasantness. Whenever the relation is conscious, it is indubitably a complex of the familiar elements. But the path of habit leads, here as elsewhere, from the conscious to the unconscious; a relational word may switch one's ideas into a new direction, without any traceable representation of the relation within consciousness. It is, then, conceivable that the imageless relations of the text mark a half-way stage between kinaesthetic set and unconsciousness; that, in certain individuals, a faint glow of consciousness still plays about excitatory processes which, in other individuals, are altogether unconscious. It is more probable that a systematically controlled introspection will, in all cases of consciousness, reveal the imaginal character of the feeling of relation.

*Reality and Unreality.*—The feeling of relation may be considered as typical of the alleged elementary processes which, like affection, cannot stand alone in consciousness. Other such processes are the feelings of reality and unreality, which are brought out, *e.g.*, by the comparison of memory-images with images of imagination (§ 118). The image of imagination may appear unreal because, as the observers say, there is nothing to do about it; it is there, clear and substantial, but it does not provoke any kinaesthetic response. The meaning of unreality is carried, in consciousness, by a kinaesthetic heaviness or inertness, which somewhat resembles fatigue, but is more like the experience of

<sup>1</sup> M. F. Washburn, *The Term 'Feeling,'* in *Journal of Philosophy, Psychology and Scientific Methods*, iii., 1906, 63. The quotation has been somewhat condensed.

losing one's head, or going to pieces, in some minor emergency. On the other hand, the same image of imagination may be reported as more real than reality, as possessing a detached or independent reality. This meaning is carried in consciousness by the kinaesthetic feel of contemplative vision (steady fixation, movement of the eyes over the image, general muscular relaxation) together with the inertness just mentioned: the image is real, with a perceptive reality, because it can be scrutinised; it is independently real, because one can do nothing with it.<sup>1</sup> The reality of the memory-image is of a different kind; it is the reality of actual occurrence in past experience. The observers identify it with the recognitive feeling, in connection with the conscious concomitants of movements, and more especially of imitative and supplementary movements, — movements that rehearse the original experience, and that amplify the details of the image. These movements are surprisingly numerous and varied.

§ 141. **The Analysis of Conscious Attitude.**—It is plainly impossible to give an analysis of all the conscious attitudes. Their number is legion. And so long as a single attitude remains unanalysed, so long will there be a rallying point for the champions of imageless thought. We must therefore be satisfied to present the case for analysis, in summary form, and to leave the reader to render his own verdict.

It should be noted, first, that the doctrine of the elementariness of conscious attitudes is, in large measure, an historical accident. We pointed out, in § 138, that the original report of 'unanalysed' has gradually changed to the inference of 'unanalysable.' The word 'unanalysed' contained a strong suggestion, and the suggestion worked. No doubt, the suggestion was reinforced by facts of observation; it often happened, in the course of an experimental enquiry,

<sup>1</sup> It is, presumably, the feeling of perceptive reality that attaches to the hallucination, and gives it its hallucinatory character. For no visual image, however clear and insistent, is intrinsically an hallucination.

that an attitude could not be analysed. But here, too, suggestion has been effective; it banished from the mind of the experimenter the qualifying 'under these circumstances'; and, if we are weighing evidence, that qualification is necessary. For sometimes, in the very studies that pronounce the attitude unanalysable, introspective records are printed which already contain a partial analysis, and which show that the observers, under more favourable conditions, could have pushed their analysis farther.

Secondly, a few of the commoner attitudes have been subjected, in the author's laboratory, to a detailed investigation, and a large number of occasional attitudes have been pounced upon as they occurred, made focal, and examined as carefully as the circumstances allowed. All the reports show the same features: visual images, pictorial or symbolic; internal speech; kinaesthetic sensations, general or local, and kinaesthetic images; organic sensations. Nowhere a sign of the imageless component!

Thirdly, the attitudes thin out, if we may so phrase it, with repetition. The visual images drop away; the verbal images either disappear entirely or become fragmentary; what was at first an explicitly imaginal consciousness may lapse into a mere flicker of kinaesthesia. The change is very far from continuous; and it sometimes happens, in minds of the imaginal type, that the final stage is complicated by associations, so that consciousness regains its former complexity. Nevertheless, the change has been followed; and the new imaginal processes are recognised as irrelevant, as concomitants and not constituents of the attitude.

Lastly, the general behaviour of the attitude, in consciousness, seems to consign it to the sphere of ideas. For it may be affectively toned, and it may be indifferent; it may



be touched off, associatively, by a present idea, and it may form part of an ordinary associative complex; it may be attended to, and it may be forgotten. In a word, it behaves just as ideas behave.

We gave in § 103 an analysis of perceptive meaning. The following account, written by an observer of pronounced kinaesthetic type (§ 114), will serve both to illustrate that analysis and to fortify the second argument of the text. "Such a sentence as this comes to the mind, 'Infinity broods over all things.' Immediately with the words themselves come into consciousness the speech-motor processes and further a general background of kinaesthetic symbolism. The kinaesthetic symbol for *infinity* is found in the tendency to prolong the word, this prolongation being accompanied by the distinct impression of projecting it from the mouth and then following this projected word by definite bodily movements. There is an image or sensation of a forcible and continued ejection by the speech-motor apparatus and of a bending forward and tension of the whole body, setting itself as if for flight. There is no visual symbol here, as, for example, of extended space, or the limitless vault of the heavens on a starlit night. The whole comes in motor adjustments. The word *broods* brings an entirely different suggestion. Here the ideation centres in a distinct picture (kinaesthetic, not visual) of outstretched hands, and body bending forward and downward. *All* is symbolised by a sensation or image of roundness in the oral cavity, and by an extensive gesture (not actually executed, but merely represented) of an inclusive movement with both hands sweeping around and joining in front of the body. The symbol for *things* is the mental representation of a direct and sudden gesture with hand extended and index finger pointing out and downward."<sup>1</sup> The details will, of course, vary with individual type. When the author, in reading the article from which this quotation is taken, came to the sentence 'Infinity broods over all things,' he closed the book, and tried to analyse his own conscious attitude. The most prominent thing in consciousness was a blue-black, dense,

<sup>1</sup> S. S. Colvin, *A Marked Case of Mimetic Ideation*, in *Psychological Review*, xvii., 1910, 264 f.



arched sky, which palpitated, as if with immense wings, over a solid convex surface, — evidently the surface of the globe. *Infinity* was thus given as the spatial extent of the sky; *broods* as the wing-like movement; *over* as the visual relation of sky to earth; and *all things* as the earth itself. The attitude contained, further, a noticeable breathlessness, and a certain organic sinking; these experiences, taken together with the darkness of the visual picture and with unpleasantness, made up a feeling of shrinking dislike.

It is not necessary to dwell upon the process of reduction, to which we have several times referred in previous Sections, though the possibility of individual differences should, perhaps, again be pointed out. It is conceivable that the last shimmer of consciousness may, in some cases, be so faint and confused as to resist analysis.

There remains the possibility that every attitude has its peculiar form of combination, which would come to consciousness as non-sensory and non-imaginal. The question of a perceptive form of combination was discussed, with negative result, in § 104. In the present connection, two further arguments may be urged against it. The first is that the form of combination would attach, not, as in the case of perception, to contents arranged always on the same pattern, but to contents of very various patterns. And the second is that in extreme imageless thinking the form would appear without any contents, the grin without the cat. Indeed, those psychologists who ascribe a form of combination to the conscious attitudes seem to the author to fall into the besetting sin of a reflective psychology; they translate a logical requirement into a psychological fact; because the meaning of the attitudes is stable, they suppose that the vehicle of meaning must be always the same. Reflection of this sort will build up a system of psychology, but can never give us a description of mind.

The symbolic fragments of imagery that carry the conscious attitudes have many points of psychological interest. It may happen, *e.g.*, that an image which is integral to the attitude becomes conventionalised into a sort of picture writing, and can be deciphered only by conjecture. Thus the author sees 'meaning' as the blue-grey tip of a kind of scoop, which has a bit of yellow above it (presumably a part of the handle), and which is just digging into a dark mass of what appears to be plastic material. In all probability, meaning was first understood as something to be dug out of a subject; but there is no hint of this in the image itself. It may happen, again, that the images, while still integral to the attitude, are more or less incongruous with it, just as we speak of going for a sail when we mean to take a steamer. Most important of all: the observers are clear that certain images are constitutive of the attitude, and that certain other images are secondary and irrelevant. The author himself has frequently had this experience, but rarely in explicit form. The relevancy or irrelevancy of the images is, so to say, incorporated in the total consciousness; you do not distinguish the two classes, at the time, but you can say afterwards that these were a part of the attitude, and those merely casual associates.

We have already come across the fact of incorporation in connection with the will attitude (§ 127). It appears also in the familiar attitudes of understanding, of solving a problem, of drawing a conclusion. If you are asked: Did you understand that passage? Did you integrate correctly? Did you draw the right inference from the premises? you are ready, perhaps even with an offended surprise at the question, to answer, Yes; and yet the 'consciousness of being right' was not explicit when you finished the work. The key to all these observations may perhaps be found in the double nature, negative as well as positive, of the determining tendencies (p. 461). The conscious attitude, directed by the tendencies, is exclusive as well as inclusive; irrelevant processes are automatically set aside, relevant processes are run together. The being-run-together then means acquiescence, or relevance, or correctness, and may — under the right conditions — find expres-

sion as I agree : That was relevant : Certainly, I was right. Unless these conditions are present, in the shape of a question, the meaning does not become explicit, but lies latent in the directed processes.

This account is wholly tentative ; the attitudes have only just begun to receive serious study. The author has felt bound to call attention to the fact of incorporation, since the latent meaning is the nearest thing he has found to a form of combination. That form itself, as an imageless but conscious process, he has invariably failed to discover.

If we put together the results of the foregoing discussions, we may conclude that the conscious attitudes are always made up of the three elementary processes, sensation, image and affection, but that the sensory and imaginal processes are given under conditions very unfavourable to analysis. The attitudes presuppose all manner of complex synergy in the cortex ; the active tendencies are the resultant, or the residue, of a long course of change. Nevertheless, analysis is possible ; a process that is experienced can also be observed ; and our present partial knowledge is a promise of full knowledge if work is continued in the future.

The principal objections brought against this 'theory of condensation' are, first, that the attitudes do not possess the sensory attributes of quality and intensity ; and, secondly, that our memory of thoughts does not depend upon the law of temporal contiguity. Intensive differences are, however, recognised by several writers upon attitude, and appear in the introspective reports of observers. And if we cannot discriminate the qualities contained in an attitude, we can at any rate refer them to a particular sense-department ; while we know that it is not always easy to pick out the constituent qualities even in a tonal or organic fusion, which stands, so to say, only next door to the simplicity of sensation. Moreover, in view of the immense complexity of the physiological substrate, it is not

to be expected that mere temporal contiguity should be as effective, for the memory of thoughts, as the reinstatement or reintegration of the habitual pattern of the cortical excitations. So far, indeed, is this lack of influence from telling against the theory, that it might have been predicted from the theory. It seems, therefore, that the objections may be easily met.

The character of the underlying physiological processes is, of course, hypothetical. It is natural to suppose that the attitudes of meaning and of relation depend, in their most extreme forms, the one mainly upon the associative, and the other mainly upon the determining tendencies, while the ordinary cases of awareness require the cooperation, in varying measure and in various complication with other psychophysical factors, of both sets of tendencies. It is possible, also, that the process of reduction (cf. § 118) is itself of a twofold character: the complex of tendencies may thin out, fine down, simplify by loss of original constituents; or there may be substitution, reduction to a common denominator, the replacement of a heterogeneous group of excitatory processes by the homogeneous correlates of verbal ideas or of kinaesthetic set. All this is guesswork and plausibility, and must be taken for what it is worth. It has been further suggested that the residual glow or shimmer of consciousness, mentioned as conceivable on pp. 514, 518, is conditioned upon the subarousal, the partial excitation, of a field of tendencies; the summation of a number of weak excitations would then give rise to a diffuse and undifferentiable consciousness.

§ 142. **Language.**—There is a long-standing controversy, in psychology, on the question whether thought is possible without language. And it hinges, like many other controversies, upon the ambiguity of the question itself. If we take the human adult, as he is, and appeal to his introspection, the answer comes plain and definite: thought and reasoning, define them as stringently as we may, can go on in terms of internal speech, in terms of conscious attitudes, the “wordless summary glimpses of relation” and

direction," and in terms of images (§ 143). The attitude is as symbolic as the word, and the image may be as symbolic as the attitude; all that thought requires is a system of mental symbols. But this very statement suggests another reading of the question in discussion. Thought requires symbols; language is a system of symbols; and we have no reason to suppose that, in the history of mind, it supervened upon or took the place of any previous system. Thought and language, in other words, appear to have grown up side by side; each implies the other; and in this sense it is true to say that there is no thought without words; reasoning and language are two aspects of the same phase of mental development. The old conundrum: Why don't the animals talk? Because they have nothing to say—contains a sound psychology; if the animals thought, they would talk; since they do not talk, they do not either think.

The use of language as the vehicle of thought has both advantages and disadvantages. If we begin with the latter, we note, first, that language has developed under pressure of practical necessity (p. 57), and is therefore, for scientific purposes, incomplete. The conscious attitudes would have been recognised long ago if we had had a name for them; or, to put the case more accurately, now that we do possess a name, we can see that many of the older psychologists had noticed them, but had failed, for lack of fitting words, to make the notice emphatic. Secondly, language tends very strongly to stereotyped forms. The observer in the psychological laboratory must be trained, not only to attend, but also to express himself in words (§ 6); and the training in expression is oftentimes the more difficult part of his education. These two disadvantages may be summed up in the statement that language puts a premium on the stimulus-error; it has been developed for reference, for designation, rather than for exact description (cf. pp. 202 f., 218, and the quotation on p. 511). A third

disadvantage lies in its discreteness. Mental processes are continuous and interwoven; words are separate and come in single file.

On the other hand, language is extraordinarily flexible. If it was not made for description, at least it can be pressed into the service of scientific record, and so successfully that there is no experience, however transient and subtle, which cannot, with sufficient pains, be translated into words. The observers who tell you, despairingly, that they know what it means to 'feel pretty well,' but cannot for all their good will go behind the feeling by analysis, come a few weeks later with pages of verbal description; when once the stereotyped form is broken up, language will follow all the finest ramifications of a mental process; its wealth of distinctions seems inexhaustible; and it has within it a principle of growth, so that a new term or a new collocation of terms is at once intelligible. Here, indeed, is a second advantage: language, just because it has developed in response to practical rather than to theoretical needs, is readily understood and easily commanded; it carries the meaning that we wish to convey, and it shapes itself, automatically, under direction of that meaning. Lastly, language is permanent and constant; it fixes, as if in mosaic, the fluidity of mental experience; it frees us from the errors of memory, and thus lays at every stage of science a foundation for further work.

The actual progress of thought and knowledge is sufficient proof that the advantages of language outweigh the disadvantages. Yet the disadvantages are real and serious. We have only to recall terms like 'perception' and 'association' to realise the danger of stereotyping: for that matter, the new word 'attitude' has, as we have seen, stood by its very coining in the way of analytical description. Words, whose only value is to symbolise experience, must never be permitted to take the place of experience; they are indispensable servants, but their mastery is fatal to science.

Regarded for its own sake, as one of the great social institutions (p. 26), language has a twofold psychological interest. The origin of language marks an epoch in mental development; and the growth of language embodies the



growth of thought. The psychology of language is, however, a subject for itself, which lies beyond the scope of this book.

Since both of these problems — that of the origin of language and that of semantic change, or change of the meaning of words — bear upon certain topics that we have discussed in preceding Sections (§§ 103, 132), we may, nevertheless, devote a brief space to their consideration. The origin of speech is, according to Wundt, bound up with the origin of gesture language. A gesture may express either the feeling side or the ideational side of an emotion. The wince and brace and bitter look of § 132 are gestures of the former sort. Ideational gestures are of two kinds: demonstrative and representative. Demonstrative gesture points towards, directly indicates, the object that excites emotion: we point our finger at the thing that has frightened us, or shake our fist at the man who has made us angry. Representative gesture depicts the object, whether by a finger-drawing of its outline in the air, or by the reproduction of one of its characteristic features, or by some purely symbolic movement. Thus, a deaf-mute gesture for 'smoke' is a spiral action of the forefinger from below upwards; for 'child,' the action of cradling and rocking the right elbow in the left hand; for 'truth,' the movement of the forefinger in a straight line from the mouth. This gesture language has its own syntax, its own laws of semantic change, its own psychological history. But just as rhythm (§ 94) has become predominantly auditory, so has language passed from gesture to speech.

Rhythm, however, seems to retain its kinaesthetic component; and the movement of articulation reminds us of the original nature of speech. The word, heard or seen, which symbolises an idea, is the last term of a long period of development. At the very beginning, speech was a gesture; the essential thing about it was not the sound, but the movement. Attempts have been made to read a meaning into the sound that accompanied the movement: there is a theory which traces language to the imitation of natural sounds, and makes it begin with onomatopoeic words like *hiss*, *roar*; and there is a theory which traces it to ejaculations and arbitrary, pre-



linguistic utterances, and makes it begin with interjections and a sort of childish babble. Neither of these theories will hold water : onomatopoetic words form a very small part of our vocabulary ; ejaculatory and exclamatory language is the analogue of affective, and not of ideational gesture, and has had but little development ; and the babble of the human infant is not primitive, but corresponds to a stage in the maturing of an inherited speech-mechanism. We must, then, suppose that the sound was, at first, the incidental, meaningless accompaniment of the gesture, the articulatory movement ; that it derived a meaning from other, concomitant gestures ; and that only gradually, under the influence of continued social intercourse, did it manifest its superiority to gesture and acquire its independence. We may say, in the large, that the word heard has never had any other than a derivative and symbolic meaning, and that the self-sufficiency of the word-gesture, combined sound and movement is the origin of language.

The course of semantic change should, if interpreted aright, reveal the laws that have governed the growth of mind ; at the same time, its particular phenomena are psychological facts that call for explanation. We may say at once, on this second point, that explanation is possible in terms of associative and determining tendencies. The general law of development, from the more concrete to the more abstract, may be briefly illustrated by the words that designate perceptive processes. Thus, German *riechen*, smell, is ultimately the same with *rauchen*, smoke ; and English *smell* is connected with *smoulder*, and with Danish *smul*, dust. To *touch* is originally to pull or draw : cf. *tug*, *team*, *tuck* (in the sense of 'draw together' of cloth). The Latin *sapio*, to taste, *sapor*, taste, are connected with *sapa*, must, *sapo*, soap, *sebum*, tallow, *i.e.*, with names of substances that are readily diluted or liquefied. A further stage of the same process is illustrated by English *feel*, German *föhlen*, which at first meant to touch ; cf. Latin *palma*, English *palm* of the hand. Not till the eighteenth century were the words reserved for the affective or 'subjective' side of mind ; and even now the shift of meaning is by no means complete.

§ 143. **The Abstract Idea.** — Thought, as we have said,

may go on in terms of attitude, of words, or of images. The imaginal complex which is characteristic of thought is known as the abstract or general idea. The name is, psychologically, a misnomer; for it is no more correct to speak, in psychology, of an abstract idea, than it would be to speak of an abstract sensation. What is abstract or general is not the idea, the process in consciousness, but the logical meaning of which that process is the vehicle.

It has, however, been maintained that the idea of the abstract is itself generalised, in the sense that it is the resultant of many single memory-ideas. The idea has been compared to what is termed a composite photograph. If we wish to secure a typical face — of a statesman, of a soldier, of a consumptive, of a dement — we photograph a number of individual faces upon the same sensitive plate, giving each one a fraction of the normal time of exposure that the plate requires. As a result, we obtain a face in which the resemblances are emphasised and the differences slurred. On this analogy, the general idea, say, of man might be a visual image in which all the points of likeness between men are clear and intensive, while all points of difference are left faint and obscure.

There is no doubt that images of this composite kind exist. But they are never formed in the way suggested, by a mechanical reinforcement of the like and a mechanical suppression of the unlike elements; they are formed always under the influence of a foregone intention or suggestion. And the range of their formation is necessarily small. If the reader will try to call up an abstract idea of man, as a visual image, he will find — in all probability — that he sees, in the mind's eye, a white man dressed in civilised clothing; if he does not, he will see some similarly individual figure.

The abstract idea may represent the average height and the average proportions of the human race, but it cannot represent the average colour of skin and hair and eyes. Perhaps the psychologists who use the figure of the composite photograph forget that the photograph is uncoloured.

To illustrate the composite idea, we may quote the following passage from Huxley. "An anatomist who occupies himself intently with the examination of several specimens of some new kind of animal, in course of time acquires so vivid a conception of its form and structure, that the idea may take visible shape and become a sort of waking dream. But the figure which thus presents itself is generic, not specific. It is no copy of any one specimen, but, more or less, a mean of the series."<sup>1</sup> Huxley, it will be noted, confines himself to form and structure. Moreover, the anatomist is working under the suggestion of a type, of a composite picture that will make a diagram for a monograph or text-book, and this antecedent determination, rather than the mere repetition of specimens, is responsible for the abstract idea.

An abstract idea is any idea whose meaning is abstract. And meaning, as we saw in § 103, appears psychologically as context, as the processes that accrue to the given process through the given situation, under a particular suggestion or instruction. Hence an abstract idea is any idea, however individually pictorial, whose context and determination carry the meaning of abstractness or generality. As a rule, the abstract idea is first presented in verbal form, as what is called a concept, while the context, perceptive or imaginal, may or may not be verbal. In minds of the verbal type, the idea remains verbal; in minds of the imaginal type, the word may be supplemented or even replaced by some imaginal process. But this imaginal form of the abstract idea is then secondary, not original.

<sup>1</sup> T. H. Huxley, *Hume*, 1881, ch. iv., 96 f.

The notion that the abstract idea must itself be abstract harks back to the fundamental error of associationism. If the individual idea is the idea of the individual, the idea that means individual (§ 106), and if the abstract idea is intrinsically the idea that means abstract, then of course the fusion or blending of a number of individual ideas will give us an abstract idea; the individual cat-meanings of our experience, run all together, will issue in a resultant, generalised cat-meaning. But, psychologically, no idea is intrinsically an individual or an abstract idea, just as no idea is intrinsically a memory-idea. An idea becomes abstract by its setting; the idea itself may be photographically particular.

In the author's mind, the context that means 'this is abstract' is usually a visual schema, a closed visual pattern; the particular cases seem literally to fit into this pattern, or into some area of it, without disturbance of the lines. In another mind of similar type the context is a vague image of an overarching dome, which covers the particulars, or to which the particulars are subsumed. We may suppose that the same context, for an observer of the kinaesthetic type revealed in the quotation on p. 517, would be the representation of some large and inclusive gesture; while for a verbally minded observer it might be an echo of the formal definition of the word employed. All this is matter for individual psychology; the point to remember is that any idea, any image, is an abstract idea, if its context is the psychological vehicle of the logical meaning 'abstract.' And in like manner any word whatsoever is a concept, if its context gives it the abstract reference.

Most of our abstract ideas come in verbal form; we grow up in an environment of language, and we become familiar with abstract words before experience has furnished the data for generalisation. In minds of the verbal type, the abstract idea of honesty or pride is then just the word 'honesty' or 'pride' as it appears in internal speech. In minds of the visual type, the verbal ideas are accompanied (or under certain circumstances replaced) by conventional pictures: the idea of value, *e.g.*, by the image of a man putting something into a scale, or the idea of pride by the image of a strutting, swelling figure. When the author happens to think

of cows, he sees a longish rectangle ending to the left in a sort of exaggerated pout; when he thinks of horses, he sees a double curve and a rampant posture with a suggestion of mane.

While, however, it is true that there is no such thing as an abstract idea, or a concept word, in the sense of associationism, it is also true that the dropping out of the context, and the lapsing of the determination from consciousness, leave us with images and words that have the character of abstractness, so to say, incorporated within them. The composite or conventional pictures, once formed, remain abstract in their own right; we do not need the determination or the context, later, to assure us that they are abstract. And language, as we have just remarked, comes to us ready made. We learn from the study of semantic change that all the abstract words were originally concrete; but the situations that made them abstract dropped into unconsciousness long ago, and the words themselves now have the stamp of abstractness upon them. So it comes about, not only that the conscious representation of the idea of honesty or pride is the mere word, 'honesty' or 'pride,' as it occurs in internal speech, but also that this same internal speech embodies the meaning of abstractness; the verbal image stands both for idea and for context.

§ 144. **Generalisation and Abstraction.**—We have spoken of the abstract or general idea, as if the adjectives were interchangeable. The processes of abstraction and generalisation are, in fact, very closely related. When we abstract, we pick out the features of a situation that are relevant to our present determination, and neglect or discard its other features. When we generalise, we bring to light likenesses that have been masked by differences: but this statement implies that we neglect the differences, as irrelevant, and pick out the likenesses, as relevant; and that is a special mode of abstraction. We may, perhaps, read a difference into the two experiences by making abstraction mainly negative, the discarding of the irrelevant,

and generalisation mainly positive, the bringing together of the similars which are relevant.

Abstraction, then, is the necessary result of determination. We have seen that all determination is double-faced, inhibitive as well as facilitative (p. 461); and we have seen, further, that the observers in the associative reaction experiment instinctively narrow or specialise their instructions (p. 445). Experiments made with the direct aim of studying the process of abstraction confirm and illustrate these results. Various arrangements of four three-letter nonsense syllables, written in different colours, were exposed in a dark room, by means of lantern projection, for a period of  $\frac{1}{8}$  sec. The observers were required, in successive series, to devote their attention especially to the following points: the total number of letters visible, the colours and their places in the visual field, the figure formed by the arrangement of the syllables, and the determination of individual letters and of their positions in the field. It was found, as we should expect, that the introspective report was fullest, most nearly correct and most definite when it dealt with that aspect of the visual complex to which attention had been given. On the negative side, it appeared that there were degrees of abstractive difficulty; the letters and their number could be more easily neglected than colour and figure; and as the direction of attention upon the former characters proved to be the more difficult task, we may say that a negative abstraction has the more pronounced effect, the greater the difficulty of the corresponding positive instruction. As regards the twofold nature of determination, it is interesting to note that this negative side of abstraction showed itself either in complete suppression or in indefiniteness of apprehension: a figure might be correctly described, while nothing at all could be said of letters or colours; or letters might be correctly named, while the colours were reported merely as like or different, as dark or light, or as such and such colours in unknown arrangement. When no preliminary directions were given, the observers instinctively set themselves the easier tasks; thus, the letters and their number were less often reported than colour and figure.



Experiments upon the elementary process of generalisation, upon the positive abstraction of similars, have been made as follows. Groups of nonsense forms, arranged as in Fig. 65, were shown to the observer, under the conditions just described, for a period of 3 sec. The groups were of varying complexity, but always contained one common element; and the instruction was to await the exposure with as even as possible a distribution of attention and then, when the figures appeared, to pick out the two that were alike.

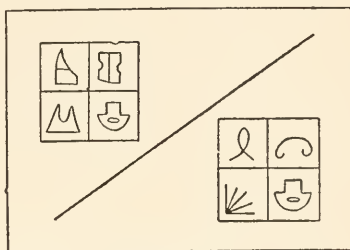

FIG. 65. Group of forms for abstraction of the like.—A. A. Grünbaum, *Arch. f. d. ges. Psych.*, xii., 1908, 347.

No less than eight modes of procedure were distinguished. The observer might work through the forms with full knowledge, excluding one by one those that were unlike; this method is laborious, and is employed for the most part only in practice experiments. Or he might travel over the groups, back and forth, until he lit upon a form which appeared familiar; this is the method of simple recognition. Or again he might set out on his journey of exploration, and find himself suddenly arrested by some insistent form, some figure that stood out more clearly than its fellows. The insistence itself might be bare and unrelated, a mere subjective accentuation; or it might be accompanied by the conscious attitude of acceptance,—‘that is the figure I want’; or by an attitude of less strong assurance,—‘that may be the right one.’ Here are mixed methods, part active search and part passive impression. In other cases, the two like forms stood out in quick succession, as if the one had drawn the other after it; the experience was more markedly passive. In still other cases, there was actual simultaneity of apprehension; the two like forms sprang forth, of their own accord, either immediately or after a brief interval, without any active search from the side of the observer. Lastly, in rare instances, passivity reached its maximum: the observer looked at the field, was held at once



by some outstanding form, and knew that this was the form required, although he had not at all remarked the presence of its pair.

We cannot here enter into explanatory details ; nor, indeed, is the time ripe for a general discussion. It is enough to have pointed out the relationship of generalisation and abstraction, and to have shown that, under experimental conditions, they yield to introspective analysis. But the experimental work is hardly more than begun, and much remains to do before we can connect these simplest experiences with the processes of reflective thought.

§ 145. **Comparison and Discrimination.** — One of the commonest tasks assigned to the observers in psychological laboratories is the comparison of two mental processes, the discrimination of quality or intensity of sensation, of the duration of intervals, of the magnitude of spatial forms. In these experiments, stimuli may sometimes be presented together: colours and lines may be shown side by side, a chord may be sounded for resolution into tones. All stimuli, without exception, may be presented in succession, and with different intervals of time between the first and second members of a pair. As the conditions of observation vary, so do the details of the comparative or discriminative consciousness.

It is a tradition in psychology that successive comparison requires the intervention of an image. I have a certain experience ; if, now, I desire at some later time to compare another experience with it, I must call it up in imaginal terms, and place the idea alongside of the perception. Recognition is explained, in this way, as the comparison of a repeated experience with its own memory-image. Nothing, however, can be more certain than that the presence of an image is unnecessary ; comparison may be direct,

the immediate outcome of a determination; and if it is indirect, the mediation need not be imaginal.

Moreover, comparison is oftentimes complete — curious as the statement may appear — before the second of the paired stimuli has been presented; we are ready with our answer before the full question has been put. The absolute impression made by the first stimulus is, in these cases, the cue to the introspective report. If the first of two tones strikes us as unusually loud, or as ridiculously faint, we are ready to declare the second tone weaker or stronger, before we have heard it.

We may illustrate the first point by reference to the comparison of musical tones. The stimuli, chosen from the middle part of the scale, and differing but very slightly in pitch, were sounded for 1 sec. with intervals of 2 to 60 sec. between the members of a pair; the observers were instructed to record their introspection, with reference always to the second tone, as higher, lower, same or doubtful. Three types of discrimination were found. The first, which constituted the prevailing type for most observers, showed no trace of any imaginal representation of the first tone. In the second, the image appeared; but it was not attended to, and did not serve as basis of comparison. In the third, the image was an essential component of the discriminative consciousness.

We confine ourselves, for the moment, to reports of difference. The imageless comparisons, which formed the great majority, were either direct or indirect. In the former case, the second tone touched off the reaction word, higher or lower, as if automatically. In the latter, comparison might be mediated by explicit imagery: the visual picture of a printed musical scale or of a piano keyboard, the kinaesthetic imagery of striking a piano note a half-tone above or below another, and so on. More often, the mediation was effected by a complex of strain sensations, perhaps with less prominent visual and organic elements, which was described as a tightening or relaxing. The muscles concerned in this complex

differed with different observers : the strains might be referred to chest, throat, eyebrows, scalp and the region of the ears : but the meaning was always the same ; the tightening meant up, and the relaxing meant down, in the tonal continuum. This symbolic reference is, no doubt, the result of empathic experience, in playing or singing or listening to music, reinforced by verbal association.

If an image was present in consciousness when the second stimulus occurred, it was almost invariably thrust aside, by the direction of attention to this stimulus, and the observer's report was determined by other factors. There were instances, however, — when the conditions were novel, when the second tone failed to touch off a response, when two contradictory impulses were felt, — in which deliberate use was made of the image as a standard of comparison. Recourse was had to this method only when the observer was hesitant and uncertain ; and the results were as likely to be wrong as right.

Reports of equality or identity are less frequently based on imageless comparison than reports of difference. The presence of the image is, however, not necessary, and where an image appears, it is not, as a rule, the object of attention. The second stimulus seems, in these cases, to reinforce or flow into the image, and the recognition, while it is still direct, consequently gains in definiteness ; the second tone is apprehended, not merely as familiar, but as 'that' tone, the same tone as the other.

During the early stages of experimentation, while the conditions are new and the observers are hesitant, the report of 'same' usually expresses a negative consciousness, the consciousness of 'no difference.' The observers are disposed to find a difference, and are thrown into doubt and perplexity by the likeness of the stimuli. There may thus be a close resemblance between the attitudes expressed by 'same' and by 'doubtful'; and we have an objective index of the resemblance in the length of time that elapses, in both instances, before the report is forthcoming. Later, the report of 'same' becomes positive ; the second stimulus is apprehended as identical with the first ; the reaction is prompt.

The number and correctness of the identifications are variously conditioned. The report of 'same' may be due to the stimulus-error, to general knowledge of the conditions of the experiment. It may be due to temperament, to an impulsive as opposed to a deliberative mental constitution. It may be a secondary effect of absolute impression; if the differences presented in the series are generally large, a small difference may find expression as an identity. And, lastly, the number of the reports falls off as the time-interval between stimuli increases, because the observers maintain more nearly constant bodily conditions during the shorter than during the longer waits; and their accuracy falls off, because there are fewer cases of direct comparison and apprehension.

The observers frequently report a difference, without being able to specify its direction. This form of report, which rarely occurs, in fact, save when there is an actual objective difference between the stimuli, expresses two different modes of the comparative consciousness. The first is that which involves a reference to the image; the attention oscillates between the perception of the second stimulus and the image of the first, or between the two images, until the relation of the two becomes confused; the observer knows that the one tone is higher than the other, but cannot tell which is which. The second is that in which there is no image, and no overt process of comparison; the second stimulus sets up directly a visual or motor 'shift' which means difference at large, but not a particular difference. Sometimes a process of comparison supervenes; the image is then recalled, and the indefinite report is changed.

It has been argued, from the occurrence of these reports, that the specific experience of difference is ultimate and irreducible; and some psychologists speak of a sensation of difference, as under similar circumstances they speak of a sensation of movement (§ 100). There is, however, another explanation. We may get the impression of colour, without being able to identify the colour; of movement, without being able to state the direction of movement; of difference, without being able to particularise the nature of the difference, simply because the abstract meanings of colour,

movement, difference are more readily associated to the given perception than the determinate meanings of red, to the right, higher. Concepts naturally stand in multitudinous associative connections, and are therefore especially liable to associative arousal. We have, then, in these abstract reports of difference, the end of a scale of development which begins with the child's tendency to call every man papa and every animal pussy (p. 379). Conversely, when memory fails with advancing age, it is the concrete words which are first forgotten: personal names, particular names of all kinds: while abstract words, concepts, remain longest of all.

We have referred to what is called absolute impression in §§ 86, 112. After long occupation with any range of stimuli, we acquire a composite idea of the class, subject to the limitations of composite ideas at large; and the idea is upheld, and later replaced, by a cortical set, a nervous predetermination. It is clear that the conditions of discrimination in the laboratory are especially suited to the formation of such an idea and such a set, and we find, as a matter of fact, that they occur in all departments of work. Whenever, then, the given stimulus departs markedly from the norm, it appeals to us singly, as an exception to a rule, and touches off an immediate verbal response; and since the responses are given under a form of instruction which refers them to the second stimulus, we have a report of this second stimulus ready in mind before the stimulus itself has appeared. We are comparing the heaviness of lifted weights; an unusually heavy weight is given, and we at once reply 'lighter,' although we do not yet know what the second weight will be. Translated into logical terms, the comparison lies between the unexpectedly heavy weight and the average weight of the series; psychologically, there is no comparison at all, but a direct reaction upon the absolute impression of the first term of the stimulus pair.

The effect of absolute impression has been noted in work upon the discrimination of visual qualities (greys) and visual distances, of noise intensities and the pitch of musical tones, of cutaneous distances, of lifted weights, and of time-intervals; it has also been traced in certain spheres of memory. It may, as this list shows,

influence the observer's report in cases of simultaneous as well as of successive comparison. Our understanding of it is still, in most departments, vague and general, and its limits have not been defined; it can, at least in some cases, be avoided by a methodical variation of the experiments.

These two facts, the needlessness of the image and the effect of absolute impression, illustrate in somewhat different ways the relation of experimental to popular psychology. The absolute impression is familiar in everyday life; but it can be traced and quantified only under the conditions of the laboratory. The image, which popular psychology had assumed, was placed by experiment in its right perspective. At the same time, the rigorous instruction to compare under the four categories of greater, less, same, doubtful, lays an artificial restriction upon the discriminative consciousness, and thus prevents our passing straight from the laboratory to the comparisons and discriminations of ordinary experience.

§ 146. **Expectation, Practice, Habituation, Fatigue.** — The observer, in experiments of the sort described in the foregoing Section, is given special instructions as to the task before him. But in planning the method and recording the results, the experimenter takes account of the observer's general attitude and predisposition: of degree of attention, of trend of expectation, of stage of practice, of habituation and fatigue. Expectation, for instance, may make for or against discrimination, according as the observer is predisposed for change or for constancy of stimulus. Practice is favourable, habituation and fatigue are unfavourable to discrimination.

Attention we have discussed. Expectation, practice, habituation and fatigue have a twofold claim upon psychology. In so far as the terms designate nervous dispositions, they have an explanatory value; in so far as they designate



consciousnesses, or conscious attitudes, they must be examined for their own sake. All four are, in reality, general names, like perception, or like thought itself, covering a great variety of particular sets and experiences.

Expectation is usually described as an anticipatory attention, and the expectant consciousness is said to be dominated by an anticipatory image of the expected event. Experiments have shown, however, that the image of expectation must join the image of recognition and the image of comparison; it may be present, but it is not an essential or characteristic feature. Expectation is initiated by a suggestion, given in perceptive form, and consists of kinaesthetic and other organic sensations, sometimes accompanied by verbal ideas, occasionally by the image. These sensational elements are the conscious aspect of the perceptive determination; they are the vehicle of the meaning 'so and so is going to happen.' They derive in part from the bodily attitude of attention: tense muscles, inhibited breathing, accommodation of the sense-organs. Nevertheless, the consciousness can hardly be termed attentive; the kinaesthetic sensations are, truly, at the focus, but not in their own right; like the 'sensations of intended movement,' these 'sensations of future occurrence' are given rather as context, as meaning, than as independent processes. An observer expressed the facts in pictorial form by saying that the consciousness of expectation seemed to him to be "a ring of kinaesthesia with a hole in the middle." — In course of time, and with repetition, the expectant consciousness drops away; the suggestion which is incorporated in the initial perception then sets the organism, unconsciously, for the imminent situation.

Practice is an integrative, as distinguished from a discursive consciousness (pp. 414, 422); the focal processes are few in number, extremely clear, and protected by the negative effect of the determination against interference from casual associations. The effects of practice, if we take that phrase in its widest sense, are manifold. Thus, it was found in experiments upon the discrimination of lifted weights that the influence of practice shows itself in



no less than five different ways. It makes the observers physically stronger, — and change of physical strength may, in this case, mean a change in the absolute impression of the stimuli ; it makes the lifting more uniform ; it raises the level of attention ; it increases the likelihood of judgment by absolute impression ; and it may shift the observer's standard of comparison, so that a difference of stimuli which finds expression in ' heavier ' or ' lighter ' at one stage of the experiment may be recorded in the words ' much heavier,' ' clearly lighter ' at a later stage. All these effects are closely related ; but their number and variety prove that the general statement of the text — ' practice favours discrimination ' — covers a large number of cooperating factors.

Habituation has been defined as " a tendency, taking shape in the course of a series of similar observations, to experience and describe perceptions of similar character." The processes of the habituated consciousness are meagre, uniformly indistinct, and definitely directed by determination ; the generic likeness of their description is, therefore, due rather to lack of clearness than to qualitative resemblance. The habitual tendencies may be classified, in order of persistence and of influence on consciousness, under five headings : weakest are those that depend solely upon recency of occurrence ; next are those due to situations of great insistence ; stronger are those arising from the professional or other routine activities of adult life, and therefore referable both to recency and to repetition ; stronger, again, are those originating in training during childhood, and therefore referable to insistence and repetition ; and strongest of all are the innate tendencies which may be regarded as the resultant of all the factors of habituation in some way racially summated.

Fatigue lowers the level and lessens the duration of attention, and consequently, like habituation, is unfavourable to discrimination ; unlike habituation, it tends also to inhibit expression, and thus renders the observer's report hesitating and uncertain. It has been suggested that fatigue is essentially a muscular, as practice is essentially a nervous, phenomenon ; and many attempts have been made, in the interests both of theory and of

practice, to discover a measure of the two dispositions. The fatigued consciousness is characterised, like that of expectation, by a special organic complex, consisting of general lassitude and local strain or pain. There is no correlation between degree of fatigue, as experienced under the ordinary working conditions of everyday life, and the physiological capacity of the organism for further work; biology, therefore, can no more help us to a psychology of fatigue than it helps us to a psychology of feeling (p. 263).

§ 147. **Judgment.** — The characteristic process of thought is said, in the text-books of logic, to be the judgment. The psychological nature of judgment is still in dispute; indeed, some writers deny it a place in the psychological system. We must be content here to give a provisional and tentative description.

According to Wundt, the process of judgment may be typified by the utterance of a complicated sentence. We must know beforehand, in a general way, what it is that we are going to say; otherwise we could not carry the sentence to its conclusion. Judgment, then, presupposes what Wundt calls an aggregate idea, an idea that represents our grasp of a total situation. The aggregate idea is not uniform and stable; now one phase of it and now another become clear in consciousness (secondary attention); and within these abstracted phases the same process of differentiation is continued. The idea is thus subject to a discursive division. And as the effect of attention is always to emphasise some particular feature of the complex, or some limited group of features, which then stands in relation to the whole from which it was abstracted, the judgment shows a corresponding duality of subject and predicate. The same duality appears, indeed, in all the logical forms of thought, in the grammatical distinctions of substantive and adjective, verb and object, verb and adverb

There can be no doubt that Wundt's description holds for certain modes of the thought consciousness; and there can be no doubt, in the author's opinion, that the duality of judgment is satisfactorily explained by reference to attention. But there are also instances in which the aggregate idea is replaced by a conscious attitude, or an unconscious determination. Moreover, the relation of predicate to subject must, if it is conscious, be analysed and described.

Let us consider some of the more recent definitions of judgment, formulated on the basis of experimental studies of the thought processes. According to one writer, a judgment is 'a sequence of experiences whose procession from its first term has been determined by a conscious suggestion. As conscious experience, the suggestion is itself past and gone, but it still persists as an appreciable influence.' This definition would classify all directed associations as judgments; it would also include under judgment all the forms of voluntary action. Indeed, it would almost seem to make judgment coextensive with ideation; for in the freest play of imagination, even in day-dreaming and reverie, the course of ideas is not wholly undirected, but turns in this direction and that at the instance of suggestion.

According to another writer, who derives his definition of judgment from work upon the associative reaction, it is essential to judgment that "a relation between stimulus-idea and idea of response, a relation that is more particularly characterised as a relation of predication, shall be willed, intended, or at any rate accepted." Unfortunately, the criterion of the predicative relation, which the author took over from logic, had been included in the instructions given to the observers; they were told, beforehand, to "understand by judgment that process of thought which finds its complete linguistic expression in a predicative proposition"; so that the experimenter, in this investigation, got out of his results very much what he put in. The relation itself appeared, in introspection, as an extension, a widening of the sphere of meaning,

while the attributive relation appeared as a narrowing and restricting of that sphere; however, there was no sharp line of division, and the analysis was not carried farther. The attitudes of will and of acceptance have been mentioned in previous Sections.—In criticism, we may say, first, that the characterisation of judgment was not spontaneous, but was itself suggested to the observers; and secondly that, if we abstract from the suggestion, there is nothing in the definition to distinguish judgment from voluntary action.

A third writer describes judgment as “an experience that is connected with the consciousness of validity or with a state of assurance”; this state is “a something which, though not itself a consciousness of validity, is of such a nature that it brings an affirmative answer to the question: Was the experience valid?” We have already had instances of similar states, in the incorporated consciousnesses discussed on p. 519. The consciousness of validity appears when, in a course of ideation that proceeds from a suggestion, certain mental processes stand out insistently, force themselves upon the attention; it consists, apparently, of the organic context of these insistent processes.

Wundt's account of judgment may, perhaps, be amended as follows. A judgment is a complex ideational experience, marked by the dual division of attention, which takes shape under the influence of a foregone suggestion; the suggestion, however, may be present not only as aggregate idea, but also as verbal imagery or as attitude, and it need not be consciously present at all, but may be effective as a cortical set. The attention implied in judgment is always secondary or active attention. Judgment belongs to the same psychological genus as voluntary action; it may even be termed an internal voluntary action; the principal difference between the two experiences is that the suggestion to action involves a reference to bodily movement, and that the action consciousness closes with kinaesthesia. In detail, the con-

scious attitudes in judgment, emotive and intellectual, are of various kinds: we may be aware of the predicative relation, of the validity of our judgment, of its necessity; we may be satisfied, or relieved, or disappointed, or perplexed. Whether one or more of these special attitudes are essential to the judgment consciousness, and whether there are specific attitudinal differences between this and the consciousness of voluntary action, cannot at present be determined.

The only point in this description that calls for comment is the statement that judgment implies secondary attention. If we make judgment depend simply upon suggestion,<sup>1</sup> then it is clear that phrases like 'the grass is green,' 'man is mortal' are true judgments. Yet these phrases are put together by the automatic action of the associative tendencies, and have nothing but their linguistic duality of form to stamp them as judgments; they are, indeed, as truly associative as the phrases 'green grass,' 'badly hurt,' in which the same duality appears in different guise. It seems best, then, to reserve the name of judgment for intellectual processes in which the conditions of attention are equivocal (p. 272), and to deny it to those simplified processes that correspond, in thought, to the secondary reflexes of the psychology of action.

*Reasoning.*— If we accept the above account of judgment, reasoning will consist in a succession of judgments, which exhausts the possibilities of dual division of the given subject-matter under the given suggestion or predetermination. There are, however, two modes of conscious complication that call for a word of mention. In the first place, the judgments are related; and their relation comes to consciousness as an awareness of the sphere within which the argument is confined, and of direction within that sphere. The awareness may be carried in words, but is more often repre-

<sup>1</sup> As in the first of the definitions quoted above, p. 541.

sented by a conscious attitude. Sometimes there is an awareness of active relating; this, according to the observers' reports, is carried by the kinaesthetic sensations resulting from the sets and adjustments of active attention, which themselves vary with the nature of the suggestion. Secondly, the principle of dual division, which underlies the whole structure of thought, may be masked by the intercurrent of associations. Subject or predicate or both may be so extensively supplemented by associated ideas that the dual division seems, at first glance, to have been replaced by multiple subdivision. A careful examination of consciousness will show that the ideas in question do not derive directly from the suggestive situation, but depend upon the secondary arousal of associative tendencies.

§ 148. **The Self.** — The word 'self,' as a psychological rubric, means the particular combination of talent, temperament and character — of intellectual, emotive and active mental constitution — that makes up an individual mind. Self, as a conscious experience, is any complex of mental processes that means some temporary phase of this combination; and a self-consciousness is a consciousness in which the self, as a conscious experience, is focal. The self-experience may be as varied as are the objective relations which the organism sustains to its personal and impersonal environment. It has, however, certain fairly constant constituents: organic sensations, a visual perception or idea of the body, and the verbal ideas of 'I' and 'my.'

It is often said, in the psychological text-books, that a conscious self forms the permanent background of consciousness, and that we have but to direct our attention to this background, to bring the self to full realisation. The statement is made so frequently and so dogmatically that the author inclines to suspect the existence of individual differences. It may be that some minds are cast, so to say, in a personal mould, and that others are relatively impersonal. In the author's experience, the conscious self, while it can always be



constructed by a voluntary effort, is of comparatively rare occurrence. It is certainly lacking in the series of consciousnesses that correspond to the daily routine. It is as certainly absent from the consciousnesses of concentrated thought; the views and theories that a popular psychology describes as personal are altogether selfless in their conscious elaboration and formulation. It is also absent in situations that are supposed to give rise to self-consciousness in the sense of 'feeling that you are under observation'; there may be all the evidences of strong emotion — parched throat, burning cheeks, gasping breath, strained and broken voice, moist and trembling hands, uncertainty of all coordinated movements<sup>1</sup> — and yet not a trace of conscious selfhood. In a word, the mental life, as the author has lived it, is very intermittently personal (p. 17). The conscious self appears as a casual visitant in various contexts; oftenest, perhaps, in connection with the feeling of loneliness; but this feeling is itself, in the experience of the civilised adult, no more than occasional.

There is, no doubt, an instinctive tendency to personalisation. Mankind, as we saw in § 5, grew early into the belief that there are two permanent substances, matter and mind; the one served to arrest the flux of natural processes, the other to ensure the continuity of individual experience. We owe to the former our instinctive tendency to take the world of perception as a world of real things (p. 464), and we owe to the latter an instinctively personal attitude, of which we have had an illustration in the tendency to overestimate the stability of our affective life (p. 496). Instinctive tendencies may or may not be accompanied by consciousness: here is the opportunity for individual differences. We have, however, an admirable instance of the unconsciousness of the tendency to personalisation, in the forms of language. Conversation bristles with I and me and my, and yet there need not be the least trace of the self in the consciousnesses that the words express. It is impossible to avoid the words, and indeed there is no reason for their avoidance; the author can explain his lack of self-consciousness to the reader far more easily by saying 'I am not self-conscious' than

<sup>1</sup> Cf. the account of a first appearance before an audience given by A. Mosso, *Fear*, 1896, 1 ff.



he can by translating the word 'I' into some impersonal phrase. Our everyday speech embodies a personal metaphysics, as it embodies also the metaphysical view of interaction between mind and body (p. 13). So we all of us talk as if we accepted these theories; but when it comes to technical discussion, we make clear, in the same theory-ridden terms, whether we do or do not.

The tendency to personalisation is social in origin, and the idea of self is sustained by social experience. The individual in a primitive society is too closely connected with his family or clansmen to form any clear idea of his individual self. But he is, and he is looked upon as, an independent centre or source of action. He boasts of his prowess, and his fellows praise him; the tribe wants food, and he has his own place in the tribal hunt or raid; he is skilled in some special handicraft, and the rest resort to him to supply them with its products. Last, but not least, he is named; he has, perhaps, a title descriptive of his courage or skill, or derived from some striking incident in his life, a nickname, in addition to his tribal name. All these incidents are, as mental experiences, strongly impressive. They furnish the materials for the formation of a professional or social self-idea; and it is only a matter of time for this to be refined to the idea of the individual self. We, of the later generations, are born with the personalising tendencies stamped upon our nervous system; but we, too, obtain the idea of our self, in the first instance, from parents, teachers and companions. From the time when we begin to understand the words spoken in our hearing, we are familiar with the use of personal names or pronouns to denote different individuals. Selfhood thus comes to us from our social experience; the author cannot believe that it would come, save perhaps in exceptional cases, from introspective examination of the background of consciousness.

As regards the conscious representation of the self, there is little to add to the bare statement of the text. In the author's experience, the organic complex that means the intellectual or active self is usually kinaesthetic, and that which means the emotive self usually visceral. It has been argued that the organic sensations are especially fitted to carry the meaning of selfhood, because they are always present, and because they remain practically un-

changed throughout the lifetime of the individual. Unless, however, the organic background is the self, apart from any further self-meaning, the argument must be judged fallacious. The organic sensations are of great importance as members of associative constellations, and as the sensory elements in many intensive feelings; for both these reasons they are fitted to carry the self-meaning, as they are fitted to carry many other meanings; but their own persistence in consciousness is not necessarily an awareness of persistence, and they may point as definitely to an external reality as they point to an internal self. — The visual image of the self may be schematic, of the kind described on p. 528, or it may be pictorial; in the latter case it is usually, so far as the author's data go, the picture of the body in some unaccustomed dress or posture.<sup>1</sup>

*Multiple Personality.* — Much interest attaches to cases of what is called double or multiple personality, in which the same individual shows, at different periods, marked differences of intelligence, emotivity and conduct. The psychological key to these phenomena, which cannot here be discussed, lies in the changes of personality manifested by normal individuals under changed conditions (p. 17).

#### References for Further Reading

§§ 138–141. A general review of recent experimental work upon the psychology of thought will be found in the author's *Lectures on the Experimental Psychology of the Thought-processes*, 1909, Lects. iii., iv. The phrase 'conscious attitude' was first employed, at the suggestion of K. Marbe, by A. Mayer and J. Orth, *Zur qualitativen Untersuchung der Association*, in *Zeits. f. Psych. u. Physiol. d. Sinnesorgane*, xxvi., 1901, 1 ff. The most zealous champion of the thought-element is K. Bühler, *Ueber Gedanken*, in *Arch. f. d. ges. Psych.*, ix., 1907, 297 ff. The feeling of reality is discussed by M. W. Calkins, *An Introd. to Psych.*, 1901 or 1905, 124 ff.; cf. Titchener, *op. cit.*, 251 ff. Experimental studies of conscious attitudes in general, and of the attitude of belief in

<sup>1</sup> Every student of psychology should know Mach's picture of the self-intuition of the ego: *Beiträge zur Analyse der Empfindungen*, 1886 [tr. 1897], 14. The author would have reproduced it, were it not that he hopes by this reference to extend the circle of Mach's readers.

particular, will shortly be published in the *American Journal of Psychology* by H. M. Clarke and T. Okabe.

§ 142. W. Wundt, *Die Sprache*, 1904; O. Külpe, *Outlines of Psych.*, 1909, 13 ff. On thought without language, cf. F. Galton, *Arithmetic by Smell*, in *Psych. Review*, i., 1894, 61 ff., and James' account of the thought constructions of deaf-mutes, *Princ. of Psych.*, i., 1890, 266 ff.; *Thought before Language: a Deaf-Mute's Recollections*, in *Philos. Rev.*, i., 1892, 613 ff.

§ 143. Titchener, *op. cit.*, Lect. i.; T. Ribot, *The Evolution of General Ideas*, tr. 1899.

§ 144. Arts. *Abstraction and Generalisation*, in *Dict. of Philos. and Psych.*, i., 1901, 6, 408; O. Külpe, *Versuche über Abstraktion*, in *Bericht über den I. Kongress f. experiment. Psychol.*, 1904, 56 ff.; A. A. Grünbaum, *Ueber die Abstraktion der Gleichheit*, in *Arch. f. d. ges. Psych.*, xii., 1908, 340 ff.

§ 145. G. M. Whipple, *An Analytic Study of the Memory Image and the Process of Judgment in the Discrimination of Clangs and Tones*, in *American Journal of Psychology*, xii., 1901, 409 ff.; xiii., 1902, 219 ff.; F. Angell, *On Judgments of 'Like' in Discrimination Experiments*, *ibid.*, xviii., 1907, 253 ff. On the report of unqualified difference, O. Külpe, *Outlines of Psych.*, [1893] 1909, 348; L. W. Stern, *Psychol. d. Veränderungsauffassung*, 1898, 251. On absolute impression, the author's *Exper. Psych.*, II., ii., 1905, 304 f.

§ 146. O. Külpe, *op. cit.*, 36 ff.; W. James, *Princ. of Psych.*, i., 1890, ch. iv.; B. R. Andrews, *Habit*, in *American Journal of Psychology*, xiv., 1903, 121 ff.; W. H. Pyle, *An Experimental Study of Expectation*, *ibid.*, xx., 1909, 530 ff.; A. Mosso, *Fatigue*, tr. 1904; C. S. Myers, *A Text-book of Exper. Psych.*, 1909, 183 ff. On the elementary phenomena of practice and fatigue, W. Wundt, *Princ. of Physiol. Psychol.*, i., tr. 1904, 75 ff. An immense amount of work has been done upon the subject of fatigue; but the interests of the investigators have been physiological or psychophysical or practical, rather than strictly psychological. A recent study by C. S. Yoakum (*An Experimental Study of Fatigue*, 1909; *Psych. Rev.*, Mon. Suppl. 46) is noteworthy as emphasising the introspective problem (93 ff.), though the writer is primarily concerned with theory. This paper gives a selected bibliography of the topic (125 ff.). Tests of fatigue, together with the practical or 'applied' psychology of many of the experiments described in the present work, are discussed by G. M. Whipple *Manual of Mental and Physical Tests*, 1910.

§ 147. W. Wundt, *Physiol. Psychol.*, iii., 1903, 572 ff.; *Outlines of*

*Psych.*, tr. 1907, 302; W. B. Pillsbury, *The Psychology of Reasoning*, 1910. The three definitions are from H. J. Watt, *Exper. Beiträge zu einer Theorie d. Denkens*, in *Arch. f. d. ges. Psych.*, iv., 1905, 416, 410; A. Messer, *Experimentell-psychologische Untersuchungen über d. Denken*, *ibid.*, viii., 1906, 105, 93; G. Störing, *Exper. u. psychopathologische Untersuchungen über das Bewusstsein d. Gültigkeit*, *ibid.*, xiv., 1909, 42. Cf. Titchener, *Thought-processes*, 1909, Lect. v.

§ 148. W. James, *op. cit.*, i., 291 ff.; H. Ebbinghaus, *Grundzüge d. Psych.*, i., 1905, 8 ff. On multiple personality, T. Flournoy, *From India to the Planet Mars*, tr. 1900; M. Prince, *The Dissociation of a Personality*, 1906.

## CONCLUSION

§ 149. **The Status of Psychology.** — The psychological text-books that embody the results of experimental investigation fall into three main groups. At the one extreme are systems of psychology, in which the experimental results appear as illustrative of general psychological principles. At the other extreme are books which deal topically with the various departments of experimentation, and therewith make an end. Midway between these two classes stand the books — of which the present *Text-book* aims to furnish an example — which emphasise the necessity of an experimental control of introspection, but which seek, further, to systematise the experimental data and to relate the psychology of the laboratory to that of the pre-experimental and non-experimental treatises.

All three types have their advantages, and all three have their disadvantages. The psychologist whose systematic thinking is firmly outlined will write with a perspective; his work will be logically coherent and duly proportioned; and the need of illustrative observations will constantly suggest problems, which his students will be interested to solve. On the other hand, he will run the risk of forcing facts to suit his system, and of neglecting facts that refuse classification under his rubrics. The psychologist who confines himself to an exposition of the experiments so far made has the great advantage that he never transcends observation; his work gives us the tested materials out of

which a science may some day be built; but he is also at a disadvantage in that he lacks perspective, makes too much of this and too little of that, fails to catch the suggestion of new experimental issues from the thought of men to whom the laboratory is foreign or abhorrent. The psychologist who takes a middle position has the advantage of perspective and the advantage of the facts. His difficulty is to bring the experimental results — results of all degrees of accuracy, obtained from widely different points of view, and oftentimes partial and incomplete — into connection with what he regards as established psychological principles; to square them with what seems stable in the psychologies of tradition and reflection: and his danger is the danger of premature systematisation.

So long as men differ in temperament, so long shall we have books of these different kinds. All of them, in their own measure and degree, stand in the direct line of psychological development; for it is beyond question that the psychology of the future will be an experimental psychology. Temperament, however, is an extremely variable thing, and prompts to many other modes of psychological expression. There are still books, and good books, that pay scant attention to the experimental method. There are books that deal with all the collateral problems of psychology (pp. 43 ff.). There are books that seek to give a scientific account of the things and selves of common sense (p. 15). A representative library of psychology — books and pamphlets and magazines — is both costly and extensive; a representative knowledge of psychology, in all its forms and branches, is probably beyond the reach of any individual.

All this means, not that the student of psychology

should be disheartened, — for there is no single chapter of psychology that is closed, that cannot be amended and extended by further work, — but that he should choose his special subject within the general field. And if he decides to throw in his lot with the experimentalists of the human laboratory, he may be assured that he could not join their society at a more favourable time. The experimental method, having conquered the whole domain of nature and of life, is pressing forward to the highest reaches of mind, to thought itself. It needs no gift of prophecy to foretell that the first half of this century will mark an epoch in the history of scientific psychology.

#### References for Further Reading

§ 149. Instances of books of the first type are W. Wundt, *Outlines of Psychology*, tr. 1907; F. Jodl, *Lehrbuch der Psychologie*, 1903; of the second type, E. W. Scripture, *The New Psychology*, 1897; C. S. Myers, *A Text-book of Experimental Psychology*, 1909; of the third type, O. Külpe, *Outlines of Psychology*, 1909; H. Ebbinghaus, *Grundzüge der Psychologie*, i., 1905; ii. (a mere fragment: the work was unfinished at the author's untimely death), 1908. On the science of things, cf. A. Meinong, *Untersuchungen zur Gegenstandstheorie und Psychologie*, 1904; on the science of selves, M. W. Calkins, *A First Book in Psychology*, 1910.



## INDEX OF NAMES

- Ach, N., 469 f.  
 Adams, J., 367  
 Alechsieff, N., 264  
 Ament, W., 218  
 Andrews, B. R., 548  
 Angell, F., 548  
 Angell, J. R., 264  
 Aristotle, 161 f., 374, 479  
  
 Bain, A., 192, 374 f., 488, 503  
 Baird, J. W., 92  
 Baldwin, J. M., 44, 264, 302, 469 f., 488,  
 504  
 Bancel, J. L. des, 504  
 Barth, A., 113  
 Bastian, H. C., 160  
 Bentley, I. M., 92, 172, 373  
 Benussi, V., 339  
 Berkeley, G., 374  
 Berlioz, H., 94  
 Binet, A., 44  
 Bingham, W. V.-D., 363  
 Bleuler, E., 200  
 Blix, M., 150  
 Bourdon, B., 338, 359, 363, 504  
 Brewster, D., 316 ff.  
 Brown, T., 374 f.  
 Bühler, K., 547  
  
 Calkins, M. W., 57, 426, 547, 552  
 Chevreul, M. E., 130  
 Claparède, E., 395  
 Clarke, H. M., 548  
 Cope, E. D., 452  
 Cuyer, E., 504  
  
 Dalton, J., 84  
 Darwin, C., 453, 487, 504  
 Dauriac, L., 44  
 Delbœuf, J., 224  
 De Sanctis, S., 45  
 Descartes, R., 12, 479  
 Downey, J. E., 200  
 Dürr, E., 302  
  
 Ebbinghaus, H., 42, 224, 264, 302, 306,  
 333, 338 f., 346 f., 353 ff., 363, 366, 373,  
 380 f., 395, 402, 426, 549, 552  
 Ellis, H., 193  
 Exner, S., 173  
  
 Fechner, G. T., 219 f., 224, 285, 302, 399,  
 426, 504  
 Flournoy, T., 549  
 Fouillée, A., 504  
 Franck, F., 245 f., 248  
 Fraser, A., 426  
 Frey, M. von, 153, 159, 248, 304  
 Fullerton, G. S., 42  
  
 Galenus, C., 498  
 Galton, F., 99, 195, 197, 200, 404 f., 426,  
 548  
 Gamble, E. A. McC., 426  
 Gardiner, H. N., 503  
 Gebattel, E. Freiherr von, 504  
 Goldscheider, A., 159, 172  
 Griesbach, H., 125  
 Grünbaum, A. A., 531, 548  
  
 Hall, F. H., 45  
 Hall, G. S., 43  
 Hallock, W., 212  
 Hamilton, W., 162  
 Hammond, W. A., 374, 479  
 Hartley, D., 374  
 Hayes, S. P., 264  
 Head, H., 159  
 Heller, T., 43  
 Helmholtz, H. L. F. von, 65, 89, 92, 98,  
 108, 110 ff., 113, 187, 222, 285, 319,  
 329, 335, 338, 353, 363  
 Henle, F. G. J., 479  
 Henri, V., 172  
 Herbart, J. F., 366 f.  
 Hering, E., 84, 89 f., 92, 222, 321, 324 f.,  
 337 ff.  
 Hermann, L., 113  
 Herrick, C. J., 470

- Herrmann-Goldap, E., 113  
 Heymans, G., 427  
 Hillebrand, F., 205  
 Hobbes, T., 374 f., 390  
 Hollands, E. H., 57  
 Holmes, O. W., 318  
 Howe, M., 45  
 Hume, D., 374 f.  
 Huxley, T. H., 527  
  
 Irons, D., 473, 479, 504  
  
 James, W., 42 f., 302, 304, 349 f., 359,  
 373, 395, 404, 406, 469 f., 474, 476,  
 477 ff., 480 f., 488, 494 f., 503 f., 512 f.,  
 548  
 Jastrow, J., 45  
 Jennings, H. S., 44, 455  
 Jevons, W. S., 42, 406  
 Jodl, F., 552  
 Judd, C. H., 58, 339, 488  
 Jung, C. G., 264, 469  
  
 Kelchner, M., 264  
 Kirschmann, A., 219  
 Koenig, R., 108  
 Koffka, K., 348  
 Kries, J. von, 92  
 Kuelpel, O., 42 f., 57, 200, 205, 395,  
 469 f., 504, 548, 552  
 Kuhlmann, F., 426  
  
 Ladd, G. T., 470  
 Lange, C., 475 f., 478 ff., 494 f., 503  
 Langfeld, H. S., 470  
 Langley, S. P., 212  
 Le Bon, G., 44  
 Lehmann, A., 286, 503 f.  
 Lehmann, K., 200  
 Linnæus, C., 117, 131  
 Linwurzky, J., 427  
 Lipps, T., 302, 335, 339  
 Locke, J., 18, 374 f.  
 Lombroso, C., 45  
 Lotze, R. H., 398, 479  
 Lubbock, J., 182  
 Lucka, E., 427  
  
 MacDougall, R., 347  
 McDougall, W., 302, 470, 480, 504  
 Mach, E., 334, 359, 547  
 McKendrick, J. G., 182  
 Malebranche, N., 479  
  
 Marbe, K., 547  
 Maskelyne, N., 428  
 Maudsley, H., 479 f.  
 Maury, A., 45  
 Mayer, A., 547  
 Meinong, A., 552  
 Meissner, G., 113, 147, 155, 165  
 Messer, A., 470, 549  
 Meumann, E., 193, 264  
 Meyer, M., 57  
 Mill, J., 18, 374  
 Mill, J. S., 375  
 Miller, D. C., 113  
 Mills, W., 33  
 Moll, A., 45  
 Morgan, C. L., 33, 43 f.  
 Mosso, A., 247, 545, 548  
 Müller, G. E., 92, 205, 224, 302, 426  
 Müller, J., 131  
 Müller-Lyer, F. C., 333, 335  
 Münsterberg, H., 43, 476  
 Murray, E., 159, 349 f., 490  
 Myers, C. S., 44, 142, 395, 548, 552  
  
 Nadejde, D. C., 264, 470  
 Nagel, W., 128, 142, 172, 182, 311  
 Newton, I., 69  
  
 Okabe, T., 548  
 Opper, J. J., 335  
 Orth, J., 547  
  
 Parish, E., 45  
 Parry, C. H. H., 363  
 Passy, J., 128  
 Patrick, G. T. W., 42  
 Paulhan, F., 504  
 Pearson, K., 42  
 Perky, C. W., 426  
 Peterson, F., 264  
 Philippe, J., 426  
 Pierce, A. H., 200  
 Pillsbury, W. B., 42, 302, 549  
 Pilzecker, A., 426  
 Poggendorff, J. C., 335  
 Preyer, W., 43  
 Prince, M., 549  
 Purkinje, J., 67  
 Pyle, W. H., 548  
  
 Ranschburg, P., 381  
 Rayleigh, 106  
 Ribot, T., 45, 302, 427, 493, 503 f., 548

- Rivers, W. H. R., 44, 92, 159  
 Rogers, A. K., 12  
 Rowland, E. H., 513
- Sanford, E. C., 219, 469  
 Schaefer, K. L., 113  
 Schneider, G. H., 480  
 Schulze, M. J. S., 92  
 Scripture, E. W., 552  
 Sherren, J., 159  
 Sherrington, C. S., 159, 172, 193  
 Sidis, B., 426  
 Siebeck, H., 479, 498  
 Sighele, S., 45  
 Spencer, H., 42, 48, 264, 375  
 Spiller, G., 42  
 Spinoza, B. de, 479  
 Squire, C. S., 348  
 Starch, D., 339  
 Stern, L. W., 43, 99 f., 348, 548  
 Sternberg, W., 131  
 Stewart, D., 18  
 Störing, G., 45, 549  
 Stout, G. F., 58, 372, 468, 473  
 Stratton, G. M., 320  
 Strong, C. A., 42  
 Stumpf, C., 94, 97, 113, 263, 306, 353 ff.,  
 360 ff., 363, 473, 503 f.  
 Sully, J., 43, 159
- Talbot, E. B., 57  
 Talbot, W. H. F., 68  
 Tarde, G., 44  
 Tardieu, E., 44
- Thompson, H. B., 264  
 Thorndike, E. L., 44, 469 f.  
 Thunberg, T., 159  
 Török, L., 159  
 Truschel, L., 339
- Wachsmuth, R., 113  
 Wade, H. T., 212  
 Wallaschek, R., 200  
 Wallin, J. E. W., 339  
 Ward, J., 452, 504  
 Washburn, M. F., 43 f., 57, 182, 514  
 Watt, H. J., 549  
 Weber, E. H., 219, 224, 323, 327, 342  
 Wheatstone, C., 316 ff., 319  
 Whipple, G. M., 200, 548  
 Woodworth, R. S., 172, 512  
 Wundt, W., 42 ff., 75, 113, 128, 142,  
 182, 224, 250 ff., 263, 286, 301 f., 304,  
 335, 338 f., 346 f., 355, 360 ff., 363, 366  
 f., 392 ff., 395, 426, 427, 441 f., 452,  
 467, 469, 491 f., 503 f., 524, 540 ff.,  
 548, 552
- Yerkes, R. M., 42, 182  
 Yoakum, C. S., 548  
 Young, T., 92
- Zenneck, L. H., 131  
 Ziehen, T., 398  
 Zöllner, F., 335  
 Zoneff, P., 264  
 Zoth, O., 338  
 Zwaardemaker, H., 128, 142

# INDEX OF SUBJECTS

- Abnormal, psychology of the, 29 f.; method of, 34 f.
- Abstraction, 529 f.
- Accent, subjective, 289, 345
- Accommodation, visual, 87; sensations from, 314 f.; of attention, 297; experimental demonstration of, 297 f.; time of, 298 f.; flexibility of, 299
- Ache, sensation of, 155
- Action, definition of, 448; genesis of, 450 ff.; nature of earliest, 452 ff.; classification of, 458 ff.; impulsive, 458 f.; ideomotor and sensorimotor, 458 f.; voluntary, 459, 542; selective, 459; volitional, 460 f.; instinctive, 462 ff.; as motived by affection, 468 f.
- Acuity, visual, 324 f.
- Adaptation, law of visual, 72; general, 72; local, 72 f.; and colour mixture, 73; after-effects of, 73 f.; and contrast, 78; theory of, 92; of sense of smell, 124 f., 126 f., 136 f.; method of progressive, 126 f.; theory of, 127; of taste, 136 f., 141; of pressure, 147; of temperature senses, 151 f.; absent, in pain sense, 154; affective, 229 f.; in fluctuation of visual attention, 292 f.
- Aesthesiometry, 322 f.
- Aesthetics, experimental, 500 ff.
- Affection, as mental element, 48, 226 f.; subject to Weber's Law, 219, 250 f.; qualities of, 226, 228, 250 ff.; attributes of, 228; adaptation of, 229 f.; and attention, 230, 267, 281 ff.; resembles organic sensation, 230 f., 260 f.; lacks clearness, 231 f.; shows opposition of qualities, 232 f., 242; as subjective, 233 f.; as non-localisable, 234 f., 255 f.; sensuous and ideal, 234 f.; as attribute of sensation, 237; as a sense quality, 237 f.; as unanalysed organic sensation, 237 ff.; as relation, 239; as attitude, 239 f.; experimental investigation of, 240 ff., 286; stability of, 242 f.; dependent on disposition of consciousness, 258; dependent on resultant sensory attributes, 259; physiological substrate of, 260 ff.; as motive to action, 468 f.; as reflexly excited sensation, 476, 482, 494; in James' theory of emotion, 477 f.; see Feeling
- After-image, positive visual, 68; negative, 72, 74 f.; theory of, 92; of taste, 137 f.; of pressure, 148; of temperature, 151 f.; of swimming sensation, 174, 177; of vestibular pressure, 180; of image, 199; visual, in fluctuation of attention, 293; of movement, 360; memory, 399 f.
- Alphabet, blind, 289
- Ampullae of semicircular canals, 173; sensation from, 174 ff.; theory of, 176 f.; as sense-organs of shrill tones, 181
- Analogy, use of, in psychology, 30 ff.
- Analysis, psychological, 37 f.; various aims of, 58; of perception, 350 f., 369, 372 f.
- Animal psychology, 10, 27; method of, 31 ff.
- Anosmia, partial, 127
- Apperception, 286, 301; doctrine of, 366 f.
- Apprehension, direct, 410 ff.; disturbance of, 412 f.
- Association, Aristotle's rules of, 374; traditional laws of, 374 ff., 379 f.; two meanings of term, 377; law of, 378 ff.; not an affective phenomenon, 378 f.; implies attention, 379, 383, 386; initiated by similars, 379; experimental study of, 380 ff., 443 ff.; remote, 385, 388, 402; direct, 385, 388, 402; retroactive, 385, 402; incidental, 385 f.; mediate, 386; modes of, 389;

Association — *Continued*

- and perception and idea, 389 f.; successive and simultaneous, 390; classification of, 390 f.; introspection of, 391 f.; conscious mechanism of, 394; physiological mechanism of, 394; verbal, 397 f.; breaking up of, 401 f.; individual differences in, 405.
- Attention, required by observation, 20, 24 f.; possible without feeling, 230, 267, 278, 283; various meanings of term, 265 f.; implies redistribution of conscious contents, 266 ff.; relation of, to kinæsthesia, 267, 281 ff.; development of, 268 ff., 275 f., 281 ff.; conditions of primary, 268 ff.; primary or passive, 270, 275, 281; secondary or active, 272 f., 275 f., 281 ff.; due to complexity of nervous organisation, 272; derived primary, 273, 275 f., 282 f.; relative complexity of primary and secondary, 266; increases sensory intensity, 279 f.; genetic relation of, to affection, 281 ff.; experimental investigation of, 284 ff.; problems of, 286 f.; range of, 287 ff.; duration of, 291 ff.; degree of, 293 ff.; accommodation of, 296 ff.; inertia of, 299; physiological substrate of, 299 ff.; in retinal rivalry, 320; and qualitative perception, 349 f.; and association, 379, 383, 386; in recitation of learned series, 384; and imaginal type, 405; and memory, 413 f.; and imagination, 422; in simple reaction, 432 ff.; in emotion and sentiment, 499; implies dual division, 540 f., 543, 544
- Attitude, conscious, 330, 333 f., 398, 423, 433 ff., 443, 445 f.; nature of, 505 ff.; intellectual and emotive, 505 f.; analysis of, 515 ff.; theory of, 520 f.
- Attributes of mental elements, 50 ff., 228; resultant, 54 f., 259
- Audition, 93 ff.; theory of, 110 ff.; late development of, 181 f.
- Automatograph, 245 f., 247
- Beats, tonal, 104 ff.
- Bias, influence of nervous, on consciousness, 274 f.; *see* Predisposition; Set, nervous
- Black, qualities of, 59 f.; production of, 65, 90; a positive sensation, 65; behaviour of, in adaptation, 75; in contrast, 76, 92; theory of, 90, 205
- Blind, spatial perception of, 308, 331, 338; warning sense of, 331 f.
- Blind spot, 88, 328 f.
- Calm, 250 ff.
- Canals, semicircular, function of, 175 f., 176 ff.
- Causation, in physics, 37, 41; cannot be employed for explanation in psychology, 39
- Change, index of, 343 f.
- Chemistry of smell, 120 f.; of taste, 132 f.
- Chroma, 54, 62 f., 64; and wavelength, 66; and energy of light, 66 f.
- Classification of psychology, 43 ff.; of mental elements, 49 f.; of sensations, 55 ff.; of visual sensations, 59 ff.; of auditory sensations, 93 ff.; of olfactory sensations, 117 f.; of tastes, 130 ff.; of action, 458 ff.; of emotion, 489 ff.
- Clearness, as attribute of sensation, 53, 278 f.; lacking, in affection, 231 f.; characteristic of focal processes in attention, 266 ff., 277 ff.; variations in focal, 290; implies nervous facilitation, 300 f.
- Cold, sense of, 145, 149 ff.; spots, 149 ff.; sensations of, 149 f.; end-organs of, 150; paradoxical sensation of, 151
- Colour, sensations of, 60 ff.; antagonistic or complementary, 68 f., 103, 232
- Colour-blindness, normal, of indirect vision, 83; abnormal, 83 ff.; partial, 83 ff., 91; why difficult of detection, 84; two types of, 85; total, 85
- Colour-depth, 54, 62 f., 95
- Colour-equations, how far independent of energy of light, 71, 80
- Colour-mixture, laws of, 68 ff., 121 ff.; corollaries to, 70 f.; and adaptation, 73; theory of, 91; binocular, 321
- Colour-pyramid, 63 f.
- Colours, primary, 85 ff.; principal, 86; fundamental, 87; invariable, 87, 90, 126
- Colour-tone, 54, 61
- Combination, form of, 371 ff., 409, 518
- Combinational tones, 103, 106 ff.; theory of, 112

- Common sense, its view of the world, 9 f., 12 f.; and scientific psychology, 10 f.; as past philosophy, 11; postulates substances, 15 ff.; confuses mental with physical, 40, 202 f.; science of, 551 f.
- Comparison, 532 ff.; of sensations and sense-distances, 216 ff., 361 f.
- Complex, associative, 446
- Conation, 467 f.
- Concept, 527 ff., 536
- Cones, retinal, as end-organs of daylight vision, 88, 90, 324; perception of extents by single, 327
- Congruity with consciousness, as determinant of primary attention, 269 ff., 282, 296
- Consciousness, as self-awareness, 17 f.; as cross-section of mind, 18 f.; as direct object of psychological study, 19; in what sense recurrent, 19; defective, 29; social, 29; interpretation of the animal, 32 f.; levels of, 276 ff., 281 ff.; goal of experimental investigation, 285; variations in, 290; associative, 389 ff., 444 f.; recognitive, 407 ff.; memory, 413 ff.; imaginative, 421 ff.; action, 448 f.; appearance of, 451 ff., 457; instinctive, 463 f.; will, 466 f.
- Consonance, theories of, 361 f.
- Contact, sensation of, 146
- Context, conscious, as aid to classification, 57; *see* Meaning
- Contiguity, association by, 375 f., 379 f., 394 f.
- Contrast, visual, 76 ff.; laws of, 76; of shadows, 77 f.; and adaptation, 78; theory of, 91 f.; of tastes, 137, 140 f.; affective, 140, 232 f.; association by, 375 f.
- Convergence, sensations from, 314 f.
- Correspondence, retinal, 309 f.
- Cramming, 406
- Custom, as witness to the distribution of mind, 26, 28
- Daltonism, 84 f.
- Daylight vision, 79 f.
- Degree of attention, 293 ff.; and effort, 294 f.; and distraction, 295; plan for measurement of, 295 f.; tests of, 296
- Depersonalisation, 425 f.
- Depression, 250 ff.
- Depth, perception of, 306 ff.; tactual, 306 ff.; visual, 308 ff.; monocular, 315; indirect criteria of, 313, 316; direct criteria of, 315 f.; limen of visual, 324 f.
- Derangement, mental, 29 f., 34 f.
- Description, 36, 37 f., 510 f.
- Diaphragm, sensitivity of, 183 f.
- Difference, experience of, 535 f.
- Differences, just noticeable, 213 ff.
- Differential psychology, 27 f., 403 ff., 544 f.
- Dimensions, spatial, 307 f.
- Direction, law of identical visual, 325
- Discrimination, 532 ff.; temporal, 342
- Dissociation, 401 f.
- Distance, interocular, 311, 324 f.
- Distraction of attention, 295 f.
- Dizziness, 175 f., 177 f.
- Duration, as attribute of sensation, 53, 340 ff.; of affection, 228
- Duration of attention, 291 ff.; visual, 291 ff.; cutaneous, 291 f.; auditory, 291 ff.
- Dynamogenesis, 488 f.
- Dynamograph, 246
- Ear, an analysing organ, 100; description of, 109 f.; kinaesthetic organs of internal, 173 f.
- Effort, as kinaesthetic sensation, 163, 170; and degree of attention, 294 f.
- Element, conative, 49, 57, 467 f.
- Elements, mental, 46 ff., 49 ff., 372 f.; three classes of, 47 f.; relational, 48 f., 512 ff.; thought, 49, 508 ff.; groups of, 49 f.; attributes of, 50 ff.; isolation of, 50 f.; psychological and psychophysical, 126
- Emotion, nature of, 471 ff., 491; experimental study of, 472 f.; and feeling, 473; James-Lange theory of, 474 ff., 476 ff., 481 ff.; anticipations of, 479 f.; and instinct, 480; and organic sensations, 481 ff.; unmotivated, 481 f.; truncated forms of, 483; expression of, 484 ff.; forms of, 489 ff.; composite, 492 f.; and sentiment, 499
- Empathy, in optical illusions, 333; in imagination, 417, 423; in experience of relation, 514
- Equation, personal, 429

- Ergograph, 246 f.
- Excitement, 164, 189, 192, 250 ff.
- Expansion, affective, 495
- Expectation, 537 f.
- Experience, as subject-matter of science, 2, 6, 9; shows lines of cleavage, 3 f.; dependent and independent aspects of, 6 ff., 10, 13 f.; as process, 15
- Experiencing person, definition of, 10, 16
- Experiment, definition of, 20; instances of psychological, 20 ff.; in animal psychology, 31; in social psychology, 33 f.; in psychology of the abnormal, 34 f.; instances of quantitative, 203; 208 ff.; *see* Affection, Association, Attention, Emotion, Intensity
- Explanation, 36, 39; definition of, 41
- Expression, method of affective, 243 ff.; instruments used by, 244 ff.; results from, 248 f., 253 f., 484 f., 503; combination of, with method of impression, 249
- Extent, as attribute of sensation, 54, 303 ff., 327
- Eye, in plants, 28; description of, 87 f.; hypothetical, without antagonistic processes, 205 f.; spatial field of, 305 f.; *see* Fovea
- Eye and ear method, 429 f.
- Eye-movement, importance of, for perception of depth, 313 ff.; in optical illusions, 333 ff.; in perception of movement, 358
- Facilitation, nervous, 300 f., 461, 530
- Familiarity, feeling of, 407 ff., 411, 413, 419
- Fatigue, 537 f., 539 f.
- Fear, morbid, 30
- Feeling, cannot be made object of attention, 22 f., 231 f.; lost, in visceral anaesthesia, 185, 262; various meanings of term, 225 ff.; contrasted with sensation, 225 f., 228 ff.; definition of, 228; mixed, 235 f.; experimental study of, 240 ff.; tridimensional theory of, 250 ff.; correlation found by, 253; biological significance of, 263; and emotion, 473; *see* Affection
- Fixity, neural, 456 ff., 463
- Form, perception of, 327 f.
- Formants, 113
- Fovea, night-blindness of, 79 f., 89; in total colour-blindness, 85, 89; structure of, 88, 324
- Fundamental colour, 87; tone, 101
- Fusion, in qualitative perception, 349; tonal, 351 f.; theory of, 352 ff.; and consonance, 361 f.; in Wundt's doctrine of association, 393 ff.; of emotions, 492 f.
- Galton whistle, 90, 107
- Generalisation, 529 f., 531 f.
- Genetic psychology, 34, 408, 410, 452 ff., 485 f.; false, 350 f., 369, 372 f.
- Gesture, 461 f., 524 f.
- Golgi spindles, 161, 170
- Grey, cortical origin of, 90 ff., 205 f.; function of, 91; seen at blind spot, 328 f.
- Habit, 273, 275 f.; introspective, 23
- Habituation, 537 f., 539
- Hallucination, 199, 420, 515
- Health, feeling of, 163 f., 189
- Hearing, coloured, 195
- Heat, physics and psychology of, 8, 10; perception of, 151
- Horopter, 309 f.
- Hue, 54, 61, 64; and wave-length, 66; and energy of light, 66 f.
- Hunger, 188 f.
- Idea, and perception, 376; of associationism, 376 f., 528 f.; and association of ideas, 389 f.; nature of, 393; abstract or general, 525 ff.; aggregate, 540 f.
- Illusion, of size and weight, 7, 156, 171
- Illusions, geometrical, of sight, 7, 332 ff.; of reversible perspective, 334 f.; temporal, 342 f.; of movement, 358; of memory, 424 ff.; affective, 496 f.
- Image, as mental element, 48; compared with sensation, 197 ff.; part of, in perception, 364 ff., 371; course of, in consciousness, 396 ff.; has attribute of intensity, 398; experimental study of, 397 f., 399; in memory, 414 ff.; in imagination, 424; organic, 494; composite, 526 f.
- Imagery, types of, 199 f., 366, 368, 403 ff.; relative frequency of, 199 f.; in attitude, 517 f., 519, 528; in comparison, 533 f.



- Images, double, 309; disparity of, and tridimensional vision, 310 ff.
- Imagination, and perception, 365; and memory, 416 ff.; psychology of, 422 ff.
- Imagination, image of, 416 ff., 418 ff.; theory of, 420 f.
- Impression, absolute, 312 f., 398, 533, 536
- Impression, method of affective, 241 ff.; combination of, with method of expression, 249; tells against tridimensional theory, 254 f.
- Impression, nervous, conditions of, 382 ff.; and length of series, 383 f.; and repetition, 383; and distribution in time, 383 f., 402; and reading by whole or part, 384; relation of, to learning, 384; in childhood, 402
- Impulse, 458 f.
- Inattention, 282
- Incorporation of meaning, 467, 519 f., 542
- Indirect vision, 81 ff.; parallax of, 315; acuity of, 324
- Inertia of attention, 299
- Infant, movements of, 454
- Influence, mutual, of mind and body, 11, 12 f., 13 ff.
- Inhibition, as affective quality, 252; nervous, 300 f., 461, 530
- Inhibition, retroactive, 387; terminal, 387 f.; initial, 388
- Innervation, sensation of, 169 ff., 441
- Insistence, as resultant or secondary attribute of sensation, 55, 204; as condition of affection, 259
- Instinct, 462 ff.; classification of, 463 f.; and emotion, 480
- Instruments, musical, 101 f.
- Intensities, of tone, 204, 206; of taste, 203 f., 208 f.; of smell, 204, 206; of noise, 206, 209
- Intensity, as attribute of sensation, 53, 201 ff.; experimental study of, 201 ff., 285; as independent variable, 204 ff.; of visual sensation, 204 ff.; as condition of affection, 259; as determinant of primary attention, 268 ff.; increased by attention, 279 f.; as attribute of image, 398
- Interaction of mind and body, 13
- Introspection, experimental, the method of psychology, 20 ff.; and inspection, 18, 20 ff., 24, 33; as retrospection, 22 f.; habit of, 23; general rules for, 25; in animal psychology, 31 ff., 36; in social psychology, 33 f., 36; in psychology of the abnormal, 34 ff.; and mental measurement, 215; favoured by instruction to introspect, 446; affective, 472 f.
- Itch, sensation of, 152, 155, 158
- Joint, structure and sense-organs of, 160 f., 165; sensations from, 164 f.; part played by, in perception, 166 ff.
- Judgment, psychology of, 540 ff.; implies secondary attention, 542 f.; and voluntary action, 542; experience of, 544, 546 f.
- Kinaesthesia, importance of, for meaning, 368, 371; for direct apprehension, 411 f.; in experience of relation, 513 f.; in experience of reality, 514 f.
- Kinematograph, 359
- Krause's bulbs, 150
- Kymograph, 245
- Laboratory, first psychological, 47; problems first attacked in, 240 f.
- Language, implied in observation, 20, 25, 31; as witness to distribution of mind, 26 f., 28; as gesture, 31; inadequate to mental processes, 57; as witness to organic factors in emotion, 483 f.; primitive, 486; and thought, 521 ff.; psychological advantages and disadvantages of, 522 ff.; origin of, 523 ff.; development of, 523 f., 525
- Law, as witness to distribution of mind, 26, 28
- Law, scientific, 5, 12, 38; psychological, 12, 38, 47; Talbot's, 68; Newton's, of colour-mixture, 69; of adaptation, 72; of reflex pain, 184; Weber's, 215 ff., 327, 342, 357 f.; of association, 378 ff., 395; of dynamogenesis, 488 f.; of mental growth and decay, 370, 376, 411, 483
- Laws, of colour-mixture, 68 f.; of contrast, 76; of smell-mixture, 121 ff.
- Learning, 384, 405 f.
- Levels, *see* Consciousness, levels of
- Life, genesis of, 455 f.

- Light, physics and psychology of, 8, 10, 64 f.; sensations of, 59 f., 205 f.; adaptation of, 72; conceivable without dark, 205 f.
- Light-tone, 54, 61 f.
- Limen, stimulus, 214, 221, 474 f.; differential, 214, 221 f.
- Local sign, 304, 335, 337
- Localisation, visual, 304 ff., 321 f., 324 f.; cutaneous, 305 f., 322 ff.; of fixation-point, 312 f.; secondary criteria of, in perception of depth, 313, 315; monocular, in perception of depth, 315; of organic sensations, 325 f.; of odours, 330; of sounds, 330 f.; temporal, 340 ff.
- Locality, perception of, 321 ff.; cutaneous, 322 ff.
- Lust, sensation of, 192; and affective quality, 237 f.
- Lustre, binocular, 320 f.
- Magnitude, perception of, 326 ff.
- Mass, physics and psychology of, 7, 10
- Matter, as independent experience, 6, 10, 13 f., 24; as substance, 9, 15 f.
- Meaning, psychology of, 367 ff., 376, 388 f., 517 f.; carried physiologically, 369 f., 376; in associationism, 376 f.; loss of, 425
- Measurement, mental, 207 ff.; arbitrary units of, 210; just noticeable difference as unit of, 213 ff.
- Meissner's corpuscles, 147, 155, 165
- Melody, perception of, 360 ff.; and form of combination, 372
- Memory, 396 ff., 413 ff.; and kinaesthesia, 417; illusions of, 424 ff.; emotive, 493 ff.; failure of, with age, 536
- Memory-image, 416 f., 418 f.; theory of, 420 f.
- Merkel's cells, 165
- Method of science, 19; of psychology, 19 ff., 30 ff.; of trial and error, 487; *see* Introspection
- Mind, as dependent experience, 6, 10, 13 f., 16, 24 f., 28; common-sense view of, 9 ff., 14, 17; as substance, 9, 11, 15 f., 28, 47, 267; scientific definition of, 9, 16, 25; animal, 10, 27, 31 ff.; range of, 26 f., 28 f., 30; collective, 28 f.; abnormal, 29 f.; criterion of, 32; incoherence of, 38, 40
- Mind and body, relation of, 10, 13 ff., 16, 39 ff.
- Mixed feelings, 235 f.
- Mood, 497
- Motor apparatus, tissues of, 160 f.
- Movement, perception of, 166 ff., 169, 173, 174 ff., 178 ff., 356 ff.; as determinant of primary attention, 269 ff.; biological significance of, 271; involuntary of eye, in fluctuation of attention, 293; alleged sensation of, 356 f.; function of, in perception of space, 306 ff.; extensive limen of, 357; illusions of, 358; synthesis of, 358 f.; after-images of, 360; sensations of intended, 434, 441 f.; theory of, 442; *see* Eye-movement, Kinaesthesia
- Muscle, structure and organs of, 160 f., 163; sensations from, 162 f., 204
- Music, development of, 361 ff.
- Nausea, 131, 177, 188 f., 193
- Nerve-endings, free, as organs of pain, 154, 157, 261; as peripheral organs of affection, 261 f.
- Nervous bias, as determinant of consciousness, 274 f.
- Nervous system, as correlate of mind, 14, 16, 25, 27, 31; probably, however, not essential to mind, 27; furnishes explanation of human mind, 39 ff.; *see* Facilitation, Inhibition, Physiology, Set, nervous
- Noise, sensations of, 93, 95 ff.; explosive, 95 f.; continuative, 95 ff.; and tone, 96 f.; stimulus to, 99, 103; theory of, 111; intensities of, 206, 209
- Nonsense syllables, in work on association, 380 ff., 414; in work on abstraction, 530; forms, in work on generalisation, 531 f.
- Novelty, as determinant of primary attention, 269 ff.; biological significance of, 271
- Observation, as method of science, 19; implies attention and record, 20, 24, 30; experimental, 20; *see* Introspection, Method
- Odours, classification of, 117 f.; mixture of, 121 ff.; complementary, 122, 124; adaptation to, 124 f.; localisation of, 330

- Opposition, affective, 232 f., 242
- Organic sensations, 56, 160 ff., 183 ff.; localisation of, 325 f.; in instinct, 464; in emotion, 472, 474 ff., 481 ff.; and self-experience, 544, 546 f.
- Otolith-organs, 173, 180 f.; as sense-organs of noise, 181; range and function of, 181
- Overtones, 101; beats of, 106
- Pacini's corpuscles, 161, 168, 187
- Pain, sense of, 145, 152 ff.; sensations of, 152 f., 155, 186 f.; spots, 152 f.; end-organs of, 154 f., 157, 261; affective character of, 155, 237 f.; and unpleasantness, 155, 261 f.; theory of, 157; law of reflex, 184
- Pain-blends, 154
- Parallax, binocular, 311 f.; of indirect vision, 315
- Parallelism, psychophysical, 13 ff., 39; advantages of, 14; terminology of, 14 f.
- Paramnesia, 425
- Parosmia, 127
- Passion, 497, 500
- Pathology, of vision, 85; of audition, 112; of smell, 127; of taste, 140; of temperature senses, 151; of kinaesthetic senses, 170; of ampullar sense, 176; of vestibular sense, 180; of abdominal organs, 184 f.
- Perception, nature of, 135, 364 ff.; derangement of, in visceral anaesthesia, 185; spatial, 303 ff.; of depth, 306 ff.; of locality, 321 ff., 330 ff.; of magnitude, 326 ff.; illusory, 332 ff.; theories of, 335 ff.; temporal, 340 ff.; two groups of, 343; of rhythm, 344 f.; theories of, 346 f.; qualitative, 349 ff.; tonal fusion, 351 f.; theories of, 352 ff.; simple and composite, 356; of movement, 356 ff.; of melody, 360 ff.; pure and mixed, 364 ff.; and form of combination, 371 ff.; and association of ideas, 389 f.; *see* Heat, Movement, Position, Resistance, Weight; also *see* Meaning
- Peritoneum, sensitivity of, 183 f.
- Personality, psychological, 16 f.; multiple, 547; *see* Self
- Physics, 1, 3, 5, 16, 21; and psychology, 7 ff., 24; problem of, 37
- Physiology, necessary to an explanatory psychology, 39 ff.; *see* Theory
- Pitch-number, 97 f.
- Plane, nuclear, 338
- Plants, probably mindless, 27 f.; sense-organs of, 27 f.
- Plasticity, neural, 456 ff., 463
- Pleasantness, 226, 228, 250 ff., 255 ff.; and intensity of stimulus, 259
- Plethysmograph, 245 f., 248
- Pneumograph, 245 f.
- Position, perception of, 166 ff.; after rotation, 177
- Practice, 537 ff.
- Predisposition, 309, 320, 323, 330, 334, 359 f., 369 ff., 386, 389, 473, 483, 492
- Present, conscious, 340 ff., 369
- Pressure, sense of, 144 f., 146 ff.; sensations of, 146 f., 148; end-organs of, 146 f., 155; spots, 146 f., 153; theory of, 155 f.; articular, 165; ampullar, 177; vestibular, 179; from diaphragm, 183 f.
- Pressure-gradient, 156
- Pressure spots, spatial distinction of, 323 f.; perception of extent by, 327; *see* Pressure
- Prick, sensation of, 153 f., 155
- Problem of psychology, 36 ff.
- Process, mental, 15 f.
- Pseudoscope, 319 f.
- Psychology, first beginnings of, 3 f.; subject-matter of, 6 ff., 9; definition of, 9; method of, 19 ff., 30 ff.; scope of, 25 ff.; differential, 27, 28; of animals, 27, 31 ff.; social, 28 f., 33 f.; of the abnormal, 29 f., 34 ff.; use of analogy in, 30 ff.; genetic, 34; problem of, 36 ff.; descriptive, 37 f.; explanatory, 39 ff.; classification of, 43 ff.; status of, 549 ff.; *see* Animal psychology, Differential psychology, etc.
- Purkinje phenomenon, 67, 71, 79 f., 85, 89
- Purple, visual, 89
- Qualitative perceptions, 349 ff.
- Qualities, visual, 59 ff.; auditory, 93 ff.; olfactory, 117 f.; gustatory, 129 ff.; cutaneous, 143 ff.; organic, 160 ff., 183 ff.; of affection, 226, 228, 250 ff., 255 ff.
- Quality, as attribute of sensation, 53, 59 ff., 285; often composite, 54, 61 f., 64, 93 f.; of affection, 228; as determinant of primary attention, 269 f.

- Quantity, variable, 211 ff.  
 Quincke's tubes, 107
- Range of mind, 26 f., 28 f., 30; of tones, 98; of Weber's Law, 219, 259 f.; of attention, 287 ff.; visual, 287 ff.; cutaneous, 289; auditory, 289 f.
- Reaction, definition of, 428 f., 447 f.; history of, 430 f.; technique of, 431 f.; simple, analysis of, 432 ff.; sensory, 432, 435; muscular, 432, 434 ff.; mixed, 432; norms of, 432; instructions for, 433 f.; periods of, 434 ff.; variations of, 437; compound, 437 ff.; discriminative, 438, 442; cognitive, 438 f., 442; choice, 439 ff., 442; subtractive procedure in, 443 f.; associative, 443 ff.; with negative instruction, 460 f.
- Reality, feeling of, 514 f.
- Reasoning, 543 f.
- Recognition, analysis of, 407 ff.; definite and indefinite, 409; direct and indirect, 409 f.; lack of, 410; and direct apprehension, 410 ff.; and meaning, 411 f.; and memory, 413; illusions of, 424 ff.
- Recollection, 414 ff.
- Reflex pain, 184; psychogalvanic, 243, 246, 250; action, 451, 458 f., 462; genesis of, 452 f., 462
- Relation, alleged elements of, 512 ff.
- Relationship, tonal, 362
- Relaxation, 251 ff.
- Religion, as witness to distribution of mind, 26, 28
- Remembrance, 414, 416
- Repetition, as determinant of primary attention, 269 f.
- Resistance, perception of, 168 f.
- Retention, 396 ff., 401 f., 403 ff.
- Rhythm, subjective, 289; unit of, shows differences of clearness, 290; perception of, 344 f.; visual, 345
- Rivalry, retinal, 309, 320 f.
- Rods, retinal, as end-organs of twilight vision, 88 f.
- Ruffini's corpuscles, 150; plumes, 165
- Saturation, 62
- Scale, musical, 361 ff.
- Science, definition of, 1, 3; and experience, 1 ff.; subject-matter of, 2, 6, 24; genesis of, 2 f.; differentiation of, 4 f., 6; method of, 19
- Self, psychological, 544 ff.; genesis of, 546
- Self-consciousness, 30, 544 f.
- Selves, science of, 551 f.
- Sensation, attributes of, 52 ff.; quality of, 53, 59 ff., 285; and image, 197 ff.; intensity of, 201 ff.; and affection, 228 ff., 260 f.; single, has no meaning, 367; see Clearness
- Sensations as mental elements, 48; classification of, 55 ff.; of special sense, 56; organic, 56; visual, system of, 63; number of, 64; auditory, 93 ff.; olfactory, 114 ff.; gustatory, 129 ff.; cutaneous, 143 ff., 305; kinaesthetic, 160 ff., 173 ff.; akin to cutaneous, 161; visceral, 183 ff.; of digestive system, 187 f.; of urinary system, 189; of circulatory system, 189 f.; of respiratory system, 190 f.; of genital system, 191 ff.
- Sense, see Common sense
- Sense, ampullar, 174 ff.; theory of, 176 ff.; vestibular, 178 ff.; theory of, 180 f.
- Sense-distance, 202 f., 208 ff., 214, 220 f., 361 f.; as continuous function of stimulus-difference, 222
- Sense-feeling, 227 f.
- Sense-organs, 10; of plants, 27 f.; defect of, 29 f.; as basis of classification, 55 f.; of smell in fish, 116; disability of, with advancing age, 139 f.; problematic, of skin, 165 f.; of internal ear, 174
- Senses, higher and lower, 114; cutaneous, 143 ff.; kinaesthetic, 160 ff.
- Sentiment, nature of, 498 f.; definition of, 500; forms of, 500 ff.; aesthetic, 500 ff.; intellectual, 502; social and religious, 502 f.; expression of, 503
- Set, nervous, 309, 320, 323, 330, 334, 369 ff., 376, 386, 398, 422 f., 445, 461, 536
- Shadows, contrast of, 77 f.
- Shivering, 190
- Similarity, association by, 375 f., 379 f., 394
- Situation, psychological, 367, 369, 478, 490
- Skimming, 406

- Skin, sensitivity of, 144 f.; spatial field of, 305 f.
- Smell, sensations of, 114 ff.; related to taste, 115 f., 135 f.; confused with taste, 115, 129; development of, 116; character of sense of, 116, 119; alleged degeneration of, in man, 116; organ of, 123; theory of, 126 f.
- Smell-mixture, laws of, 121 ff.; theory of, 127
- Social psychology, 28 f.; method of, 33 f.
- Sound, physics and psychology of, 8, 10; localisation of, 330 f.
- Space, physics and psychology of, 7, 10, 12; perceptions of, 303 ff.; variety of psychological, 329 f.; secondary, 330 ff.; illusory, 332 ff.; theories of, 335 f.
- Specialisation, associative, 445 f., 461; of instinct, 465
- Spectrum, solar, 60 f.; distribution of energy in, 66; and coloured papers, in colour-mixture, 68, 70; in indirect vision, 83; in partial colour-blindness, 83 f., 85
- Sphygmograph, 245, 248
- Stereoscope, reflecting, 316 f.; refracting, 316 ff.
- Stimuli, external and internal, 56; secondary effects of, in smell, 118; olfactory, character of, 119 ff.; gustatory, character of, 131 ff.; organism's general response to, 194, 258; subliminal, 210; terminal, 210 f.; liminal, 211 ff.
- Stimulus-error, 202 f., 218, 350, 398, 522
- Stomach, sensitivity of, 186, 188
- Strain, sensation of, 163, 168, 170, 193
- Strangeness, feeling of, 417 f., 419, 423
- Stroboscope, 358 f.
- Substances, Hering's visual, 90
- Suddenness, as determinant of primary attention, 269 ff.; biological significance of, 271
- Suggestion, 449 f.
- Swimming in head, sensation of, 174 f., 176 ff
- Synaesthesia, 194 ff.; theory of, 196 f., 420 f.
- Synthesis, psychological, 38; of tridimensional space, 316 ff.; of visual movement, 358 f.
- Taste, sense of, 129 ff.; related to smell, 115 f., 135 f.; organ of, 138 f.; theory of, 140 f.; development of, 141; spatial value of, 305
- Taste-blends, 129 ff.; unitary character of, 134 f., 141
- Taste-mixtures, 133 f.
- Telestereoscope, 319
- Temperament, 498
- Temperature, sensations of, in taste-blends, 130 f.; two senses of, 145, 149 ff.; in pain-blends, 154
- Temperature-blends, 154
- Temporal sign, 346
- Tendency, associative, 384 ff., 395, 400 f., 401 f., 521; effect of age upon repetition, 402; and reaction time, 446
- Tendency, determining, 449, 461, 521, 530
- Tendency, impressional, 383, 395, 400 f.
- Tendency, instinctive, 464 f., 545
- Tendency, perseverative, 400 f., 437
- Tendon, structure and organs of, 160 f., 163; sensations from, 163, 168, 170, 204
- Tension, 251 ff.
- Theory, of twilight vision, 88 f.; of daylight vision, 89 ff.; of tone and noise, 110 ff.; of smell, 126 f.; of components, 126; of taste, 138 ff.; of cutaneous sensations, 155 ff.; of tickle and itch, 156 ff.; of muscle sense, 163; of tendon sense, 163; of joint sense, 165; of ampullar sense, 176 f.; of vestibular sense, 180 f.; of thirst, 187; of nausea, 188; of hunger, 188; of shudder, shiver, goose-flesh, 190; of stiffness, suffocation, distress, 191; of lust, 192; of synaesthesia, 197, 420 f.; of sensible intensity, 222; of affection, 260 ff.; of attention, 299 ff.; genetic and nativistic, of space perception, 335 ff.; of time perception, 346 f.; of tonal fusion, 353 f.; of qualitative perception, 355; of movement, 356 f., 360; of image of imagination, 420 f.; of sensations of intended movement, 442; general, of mental phenomena, 489
- Things, science of, 551 f.
- Third dimension, *see* Depth
- Thirst, 187, 189
- Thought, alleged element of, 508 ff.; imageless, 512 f., 514, 518, 521; and language, 521 ff.

- Tickle, sensation of, 146, 157 ff.; theory of, 158 f.; and affection, 237 f.
- Timbre, 98, 101 ff., 113
- Time, physics and psychology of, 7, 10; perceptions of, 340 ff.; bidimensional, 340 f.; and space, 341; perception of rhythm, 344 f.; theories of, 346 f.
- Tingling, 190
- Tint, 54, 61 f., 64; and wave-length, 66; and energy of light, 66 f.
- Tomsa's knots, 165
- Tonal islands, 112; gaps, 112
- Tone-colour, 98, 101 ff., 113
- Tones, volume of, 51 f., 53, 94 f.; attributes of, 52, 94 f.; compound, 93, 100 ff.; system of, 94, 98; and noises, 96 f.; range of, 98; partial, 101; combinational, 103, 106 ff., 112; difference, 106 ff.; summation, 108 f. intermediate, 105 f., 108, 111; theory of, 111; formant, 113; affective value of, 256
- Touch, sensations of, in taste-blends, 130 ff.; popular psychology of, 143 f.; not an unitary sense, 145; perceptions of, 166 ff., 171 f.
- Touch-blends, 148 f., 154, 161, 171 f.
- Transfer, affective, 495 f.
- Tropism, 454 f.
- Twilight vision, 79 f.; theory of, 88 f.
- Unconscious, 40
- Unit of mental measurement, 213 ff.
- Unpleasantness, 226, 228, 250 ff., 258 ff.; and pain, 155, 261 f.; and intensity of stimulus, 259
- Vertical, perception of, by vestibular organs, 178 f., 180
- Vestibule of internal ear, 173 f.; sensations from, 178 ff.; theory of, 180 f.
- Visceral sensations, surgical evidence of, 183 f.; physiological, 184; pathological, 184 f.; psychological, 185 f.
- Vision, daylight and twilight, 78 ff.; direct and indirect, 80 ff.; theory of dual, 80 ff.; theory of twilight, 88 ff.; theory of daylight, 89 ff.; hypothetical, of light only, 205 f.; instances of bidimensional, 303; binocular, 311, 313 f., 325
- Volume, alleged sense-attribute of, 51 f., 53, 94 f., 304
- Warmth, sense of, 145, 149 ff.; spots, 149 f.; sensations of, 150; end-organs of, 150; *see* Heat
- Warning sense, of blind, 331 f.
- Weber's Law, 215 ff.; range of, 219, 259 f.; first expression of, 219; mathematical formulation of, 220 f.; theory of, 221 ff.; explains sensible intensity, 222; significance of, 223; *see* Law, Weber's
- Weight, perception of, 168 f.
- White, qualities of, 59 f.; behaviour of, in adaptation, 75; in contrast, 76, 92; theory of, 90, 205
- Will, 466 ff.
- Zones, retinal, 82 f.

---

Printed in the United States of America.



THE following pages contain advertisements of  
Macmillan books on kindred subjects.

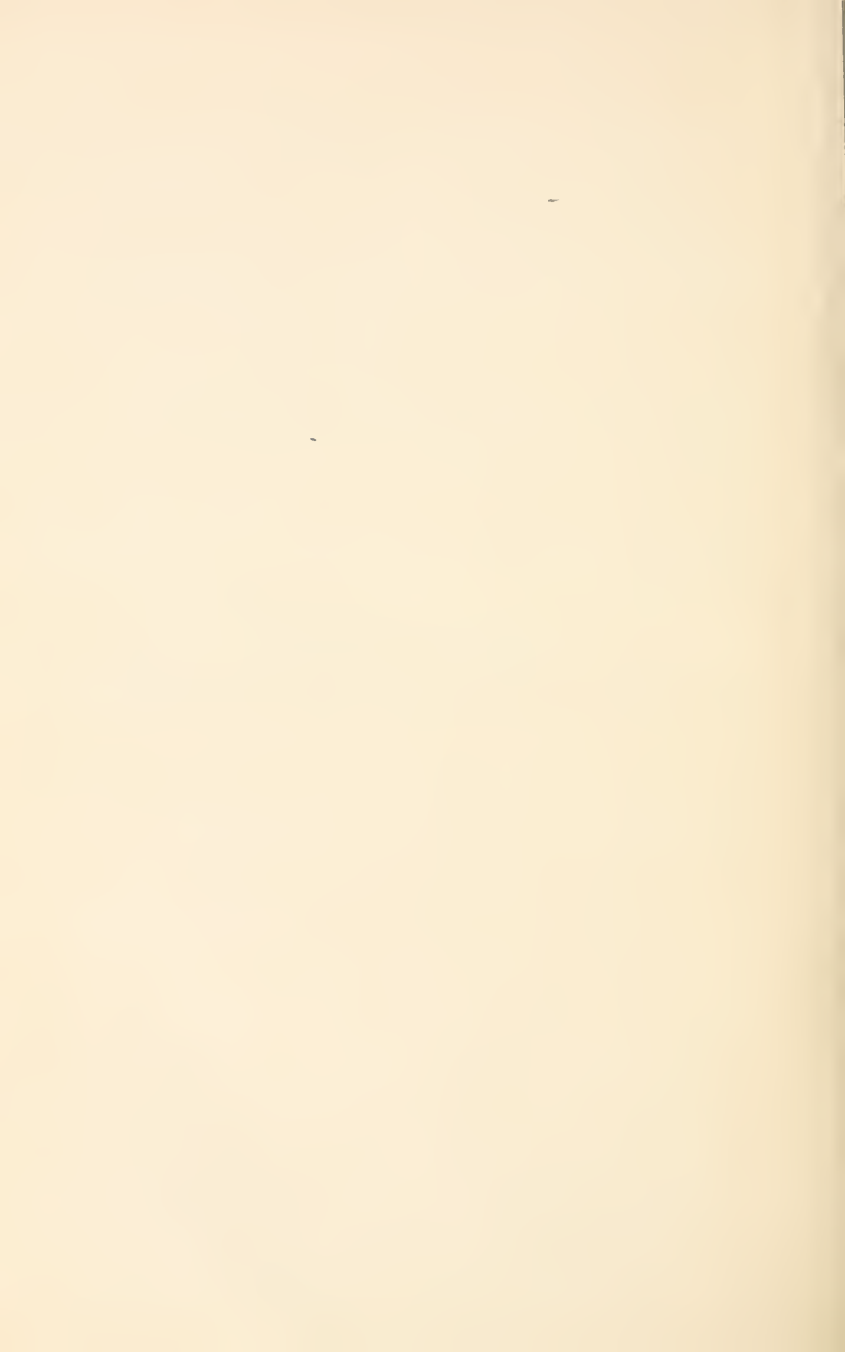

TRANSLATED BY

EDWARD BRADFORD TITCHENER

AND ASSOCIATES

## Outlines of Psychology

By OSWALD KÜLPE, Professor of Philosophy in the University of Würzburg. Based upon the Results of Experimental Investigation.

*New Edition, 1909; Cloth, 462 pages, 8vo, \$2.60*

## Introduction to Philosophy

By OSWALD KÜLPE

A Handbook for Students of Psychology, Logic, Ethics, Æsthetics, and General Philosophy. Translated by Professors W. B. PILLSBURY and E. B. TITCHENER.

*Cloth, 256 pages, 12mo, \$1.60.*

## Principles of Physiological Psychology

By WILHELM WUNDT, Professor of Philosophy in the University of Leipsic. From the Fifth German Edition (1902).

Volume I. Introduction. Part I. The Bodily Substrate of the Mental Life.

*Cloth, 3-17 pages, 8vo, \$3.00*

## Lectures on Human and Animal Psychology

By WILHELM WUNDT.

Translated by J. E. CREIGHTON and E. B. TITCHENER.

*Third Edition, 459 pages, Large 8vo, \$2.60*

## Ethics

By WILHELM WUNDT.

Translated from the Second German Edition by EDWARD BRADFORD TITCHENER, JULIA H. GULLIVER, and MARGARET F. WASHBURN.

Vol. I. The Facts of the Moral Life. Second Edition (1902).  
*399 pages, \$2.25*

Vol. II. Ethical Systems. Second Edition (1906).  
*196 pages, \$1.75*

Vol. III. The Principles of Morality and the Departments of Moral Life. Second Edition (1907).  
*\$2.00*

---

THE MACMILLAN COMPANY

Publishers, 64-66 Fifth Avenue, New York

# BY EDWARD BRADFORD TITCHENER

*D.Sc., Ph.D., LL.D., Sage Professor of Psychology, Cornell University,  
Associate Editor of "Mind" and of the "American Journal of Psychology."*

## A Primer of Psychology

This is intended as a first book, comprehensive enough to give the general reader a fair idea of the field of modern psychology, its methods of research, and an outline of its most important results. Every statement is made with as little of technical detail as is practicable. It is sufficient to meet the needs of the ordinary reader who wishes to understand something of the subject so prominent in all discussions of education and business life; the student who proposes to make a special study of psychology will find it time well spent if he reads this book first.

*Cloth, 316 pages, 12mo, \$1.00*

## Experimental Psychology

A Manual of Laboratory Practice

### I. Qualitative Experiments

Student's Manual	<i>Cloth, 8vo, 214 pages, \$1.60</i>
Instructor's Manual	<i>Cloth, 8vo, 456 pages, \$2.50</i>

### II. Quantitative Experiments

Student's Manual	<i>Cloth, 8vo, 208 pages, \$1.60</i>
Instructor's Manual	<i>Cloth, 8vo, 453 pages, \$2.50</i>

"Dr. Titchener's lucid and fascinating text-book . . . is a triumph of industry and competence." — *The Speaker*, London.

## The Psychology of Feeling and Attention

A Course of Lectures, delivered by invitation at Columbia University, which bring together all we at present know of the elementary affective processes and of the attentive state. The entire discussion constitutes a sort of critical résumé of experimental work up to 1908.

*Cloth, 8vo, 404 pages, with a bibliography and index, \$1.40*

---

THE MACMILLAN COMPANY

Publishers, 64 66 Fifth Avenue, New York

## OTHER WORKS ON PHILOSOPHY

---

### The Persistent Problems of Philosophy

An Introduction to Philosophy through a Study of Modern Systems. By MARY WHITON CALKINS, Professor of Philosophy and Psychology at Wellesley College: Author of "An Introduction to Psychology," and "Der doppelte Standpunkt in der Psychologie." New York, 1907.

*Cloth, 575 pages, 8vo, \$2.50*

### An Introduction to Philosophy

By GEORGE STUART FULLERTON, Professor of Philosophy in Columbia University. New York, 1906.

*Cloth, 322 pages, 12mo, \$1.60*

### A Brief Introduction to Modern Philosophy

By ARTHUR KENYON ROGERS, Professor of Philosophy in Butler College.

*Cloth, 360 pages, 12mo, \$1.25*

### A Student's History of Philosophy

By ARTHUR KENYON ROGERS, Professor of Philosophy in Butler College. First Edition, New York, 1901; Second Edition, 1907.

*Cloth, 511 pages, 8vo, \$2.00*

### Dictionary of Philosophy and Psychology

Including Many of the Principal Conceptions of Ethics, Logic, Æsthetics, Philosophy of Religion, Mental Pathology, Anthropology, Biology, Neurology, Physiology, Economics, Political and Social Philosophy, Philosophy, Physical Science and Education, and Giving a Terminology in English, French, German, and Italian. Edited by JAMES MARK BALDWIN, Professor of Philosophy and Psychology in Johns Hopkins University. In Three Volumes.

Vol. I. New York, 1901. A to Laws. 644 pages.

Vol. II. New York, 1902. Le to Z. 892 pages.

Vol. III. New York, 1905. In two parts: Part I, 542 pages.

Part II, 650 pages, *Cloth, 4to, Vol. I and II, \$16.00*

*Vol III. in two parts, \$10.00*

---

## THE MACMILLAN COMPANY

Publishers, 64-66 Fifth Avenue, New York

ANIMAL BEHAVIOR SERIES

# THE DANCING MOUSE

By ROBERT M. YERKES, Ph.D.

Assistant Professor of Comparative Psychology, Harvard University,  
General Editor of the Series

A study of this variety of pet mouse in relation to its peculiar whirling habit and its cause; and also of its perceptive powers, educability and mental characteristics. The book is not only of decided interest to biologists and psychologists, but has been arranged by the author with a view to its use as a text-book for college courses in comparative psychology. It introduces a proposed series of books dealing in the same studious way with the behavior of various animals, which will contain much original information and be of extreme service to students.

"Dr. Yerkes' book is a most interesting example of modern laboratory methods, and can be read with profit by any one, on account of the accurate methods of observation and careful deductive reasoning which it shows."—*Journal of American Medical Association.*

"To people who have not followed the recent developments in this field of science, the book is a revelation." *Cloth, xvi+290 pp., 12mo, illus., \$1.25.*

---

ANIMAL BEHAVIOR SERIES

# THE ANIMAL MIND

*A New Text-Book of Comparative Psychology*

By MARGARET FLOY WASHBURN, Ph.D.

Professor of Philosophy, Vassar College

The second volume of the new Animal Behavior Series edited by ROBERT M. YERKES, Ph.D., of Harvard University, sets forth simply and in a very interesting way the facts which have resulted from the study of comparative psychology. There are books on animal instincts; there are many interpretations of animal behavior; there is a mass of experimental material (for the most part inaccessible to the ordinary student) which has been accumulating from the researches of physiologists and psychologists; but hitherto we have had no book which adequately presents simple facts.

*Cloth, 12mo, 333 pages, \$1.60*

---

THE MACMILLAN COMPANY

Publishers, 64-66 Fifth Avenue, New York









57  
31  
174

THE LIBRARY  
UNIVERSITY OF CALIFORNIA  
Santa Barbara

THIS BOOK IS DUE ON THE LAST-DATE  
STAMPED BELOW.

~~NOV 10 - 1973~~  
~~NOV 10 - 1973~~

~~DEC 17 1973~~ 121



3 1205 01764 1257

UC SOUTHERN REGIONAL LIBRARY FACILITY



**AA** 000 300 877 8

